



Board of Adjustment Staff Report

Meeting Date: October 4, 2018

Agenda Item: 8E

SPECIAL USE PERMIT CASE NUMBER:

WSUP18-0017 (Soule Grading)

BRIEF SUMMARY OF REQUEST:

Thomas Creek Critical Stream Zone Buffer Area and Sensitive Stream Zone Buffer Area.

A special use permit to allow for grading within

STAFF PLANNER:

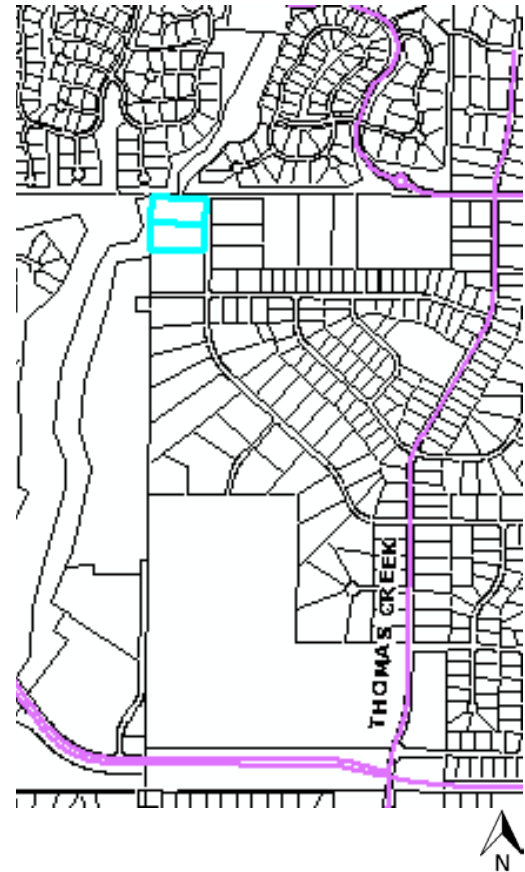
Planner's Name: Julee Olander

Phone Number: 775.328.3627

E-mail: jolander@washoecounty.us

CASE DESCRIPTION

For possible action, hearing, and discussion to approve a special use permit for grading, which was performed without the required permit(s) within a significant hydrological resource (SHR), by grading and removing vegetation within the Thomas Creek Critical Stream Zone Buffer Area and Sensitive Stream Zone Buffer Area. Grading has also taken place outside the stream zone buffer area.



Applicant/Property Owner: Randal and Kim Soule
 Location: 13410 & 13430 Welcome Way
 APN: 049-165-06 and 049-165-07
 Parcel Size: 2.77 acres and 2.4 acres
 Master Plan: Rural (R) and Suburban Rural (SR)
 Regulatory Zone: Low Density Suburban & General Rural (GR)
 Area Plan: Southwest Area Plan
 Citizen Advisory Board: South Truckee Meadows/Washoe Valley
 Development Code: Authorized in Article 810, Special Use Permits and Article 438, Grading
 Commission District: 2 – Commissioner Lucey
 Area Plan: Southwest

STAFF RECOMMENDATION

APPROVE

APPROVE WITH CONDITIONS

DENY

POSSIBLE MOTION

I move that, after giving reasoned consideration to the information contained in the staff report and information received during the public hearing, the Washoe County Board of Adjustment approve, with conditions, Special Use Permit Case Number WSUP18-0017 for Randal and Kim Soule, having made all four findings in accordance with Washoe County Code Section 110. 810. 30.

(Motion with Findings on Page 13)

Staff Report Contents

Special Use Permit.....3

Vicinity Map.....4

Site Location5

Site Plan.....6

Project Evaluation7

South Truckee Meadows/Washoe Valley Citizen Advisory Board (STM/WV CAB) 10

Reviewing Agencies 11

Recommendation 13

Motion 13

Appeal Process 13

Exhibits Contents

Conditions of ApprovalExhibit A

June 21st meeting EmailExhibit B

Fence Permit Application WBLD18-106592.....Exhibit C

Citizen Advisory Board Minutes.....Exhibit D

Public Comment EmailsExhibit E

Agency Review Letters.....Exhibit F

Agency Review Comments & Conditions Exhibit G

Public NoticeExhibit H

Project Application..... Exhibit I

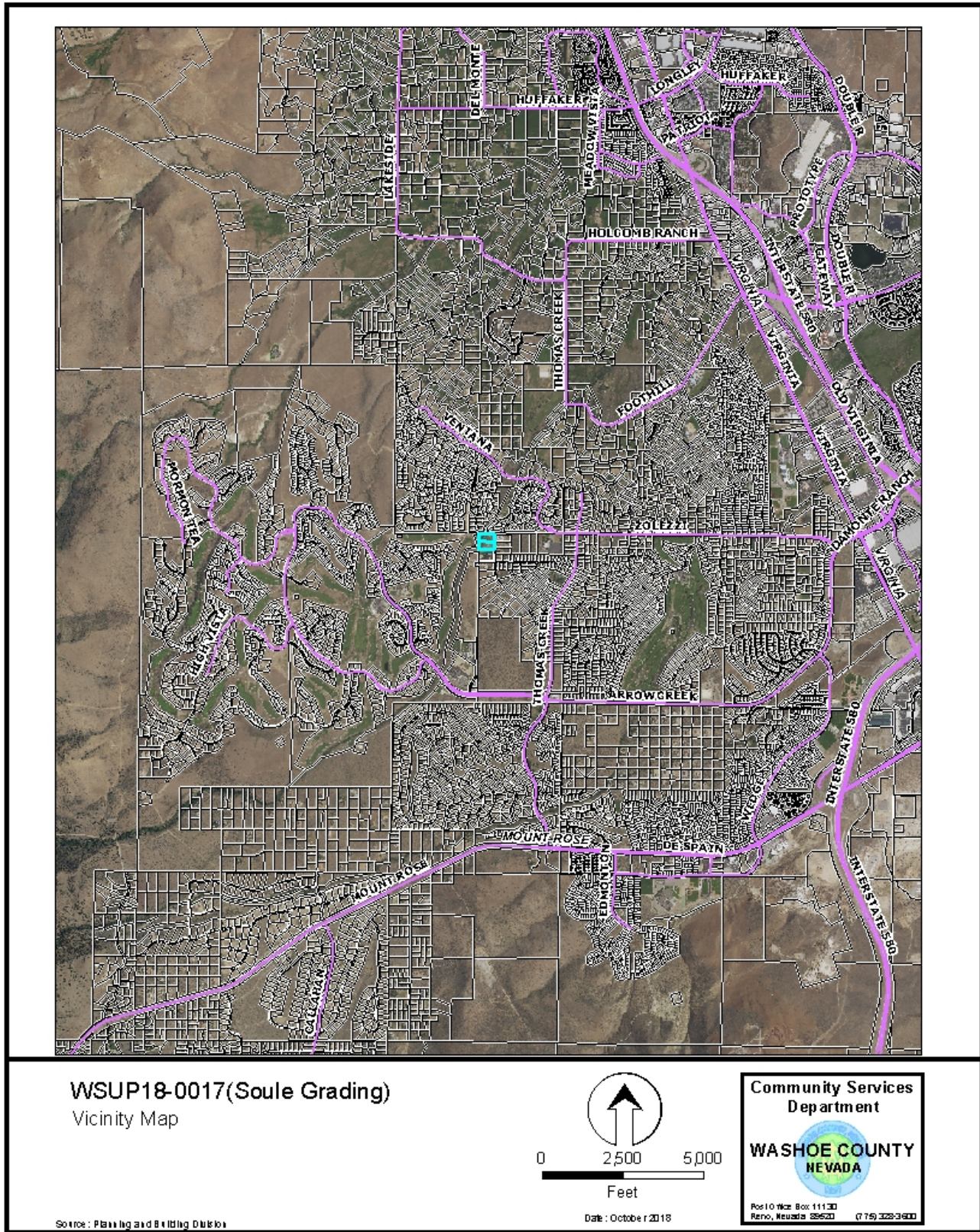
Special Use Permit

The purpose of a Special Use Permit is to allow a method of review to identify any potential harmful impacts on adjacent properties or surrounding areas for uses that may be appropriate within a regulatory zone; and to provide for a procedure whereby such uses might be permitted by further restricting or conditioning them so as to mitigate or eliminate possible adverse impacts. If the Board of Adjustment grants an approval of the Special Use Permit, that approval is subject to Conditions of Approval. Conditions of Approval are requirements that need to be completed during different stages of the proposed project. Those stages are typically:

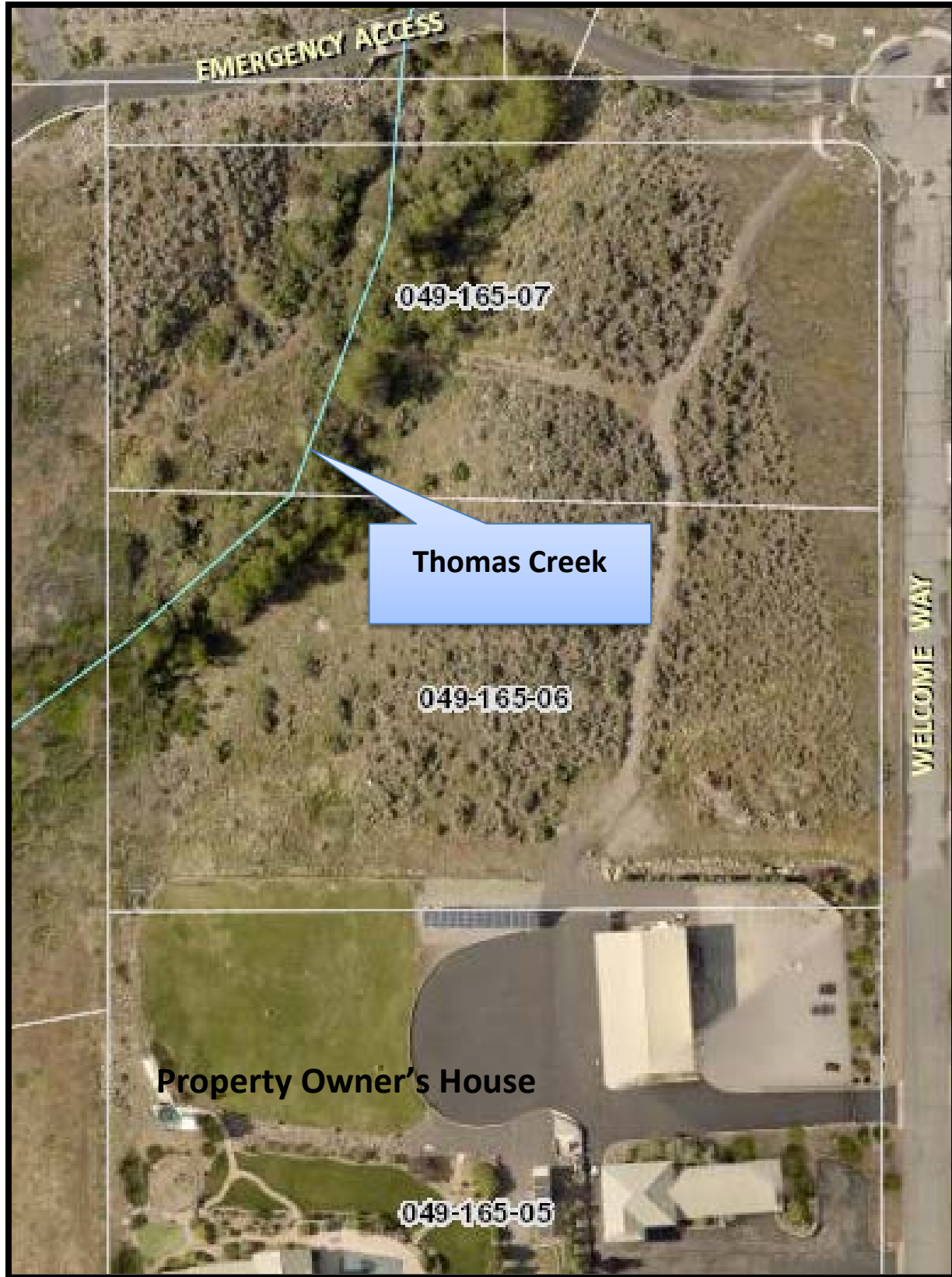
- Prior to permit issuance (i.e. a grading permit, a building permit, etc.)
- Prior to obtaining a final inspection and/or a certificate of occupancy on a structure
- Prior to the issuance of a business license or other permits/licenses
- Some Conditions of Approval are referred to as “Operational Conditions.” These conditions must be continually complied with for the life of the business or project.

The Conditions of Approval for Special Use Permit Case Number WSUP18-0017 are attached to this staff report and will be included with the Action Order.

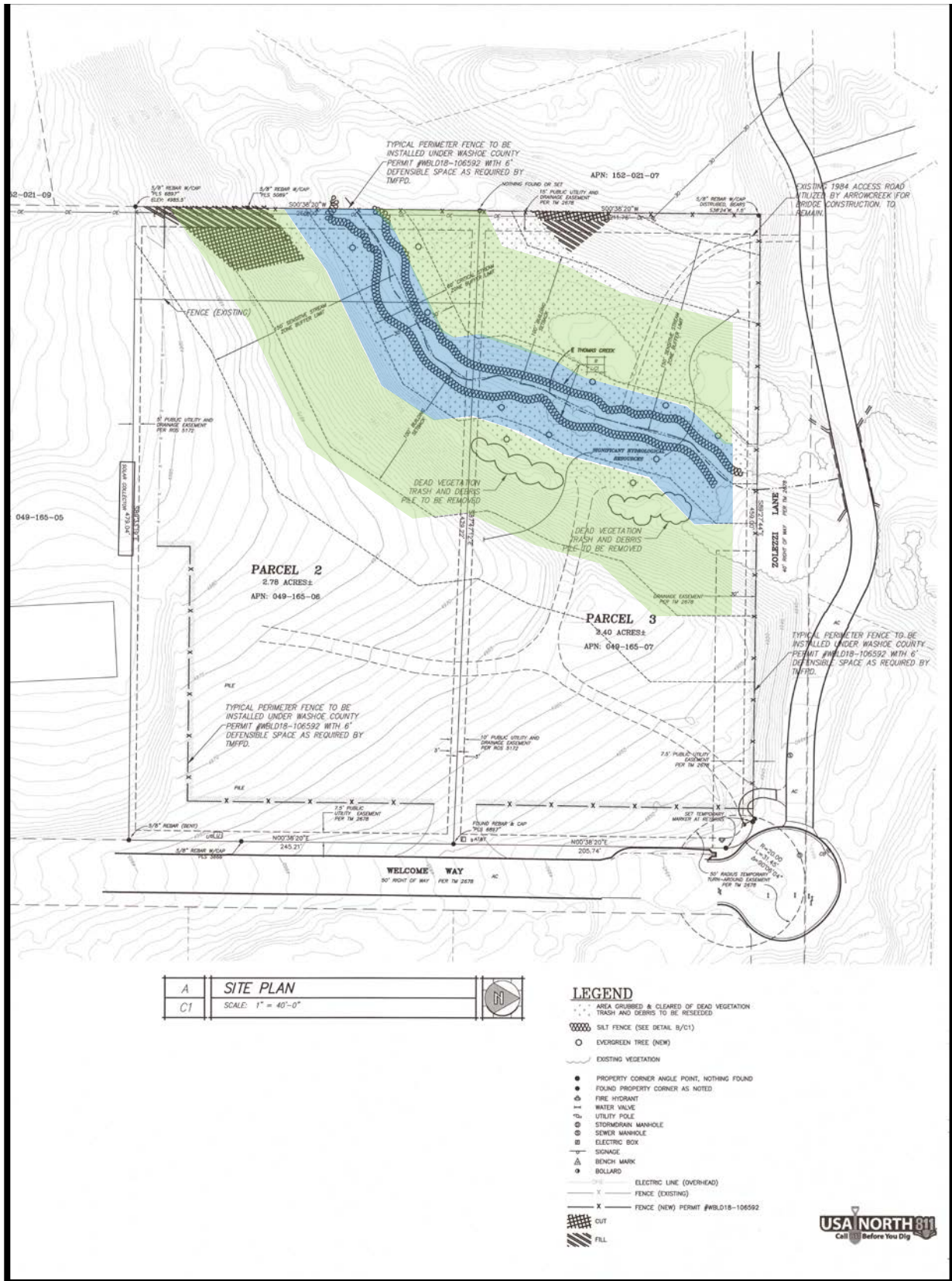
The subject property is designated as Low Density Suburban (LDS) and General Rural (GR). Grading is permitted in all regulatory zones with a Special Use Permit (SUP) in accordance with Washoe County Code (WCC) Section 110.438.35. The applicant is seeking approval of this SUP from the Board of Adjustment. The applicant has already done major grading without having first obtained the appropriate approvals from Washoe County. Therefore, the applicant is seeking approval of this SUP from the Board of Adjustment for after-the-fact grading done without appropriate permits that trigger Major Grading. The grading done includes grading within the Critical and Sensitive Stream Buffer Zones as defined in Article 418 (Significant Hydrologic Resources) of the Washoe County Development Code.



Vicinity Map



Site Location



Site Plan

Project Evaluation

In May of this year a complaint was received by Code Enforcement of “grading without a permit in a critical stream zone of Thomas Creek and all trees and shrubs were removed”. A Code Enforcement Officer went to the property owner’s house, which is on a parcel adjacent to Thomas Creek and spoke to the owner and was told that only debris and dead vegetation around the creek had been removed to prevent obstructions in the creek and no grading work had been done. The Code Enforcement Officer told the owner if any more work was done in the critical stream zone buffer area of Thomas Creek that the property owner needed to contact the County, no violation was issued. In June, another complaint was received and the Code Enforcement Officer was able to inspect the area where Thomas Creek is located on the property and confirmed that grading was being done in the critical stream zone buffer area. An administrative warning letter and stop work order were issued. On June 21st a meeting was held with the property owner and Washoe County staff to discuss the possible options to resolve the violation. The property owner was directed to not do any more grading or work in the area and was required to obtain a special use permit (SUP) for the grading in the Critical Stream Zone Buffer Area per WCC 110.438.35(a)(7) as well as a grading permit for all grading on the property. The owner would be permitted to remove the piles of dead debris that had been already cleared. (See Exhibit B)

It is important to note that under the Washoe County Development Code Article 438, grading is defined as, “any clearing, excavation, cutting, filling, or other disturbance of the natural state of the landform or natural vegetation and/or any combination thereof.” Also, the development code has specific requirements detailed in Article 418, Significant Hydrological Resources, concerning perennial streams in Washoe County. The purpose of Article 418 is to “regulate development activity within and adjacent to perennial streams to ensure that these resources are protected and enhanced.” Thomas Creek is defined as a hydrological resource by Article 418 and is identified as a U.S. Waterway by the federal government. According to Article 418, perennial stream buffer areas are, “established to provide adequate setbacks and land use controls to ensure water quality functions of each perennial stream are not jeopardized through development activity.” There are two buffer areas that are defined: the critical stream zone buffer area, which “is all land and water surface within thirty (30) feet from the centerline of the perennial stream” and sensitive stream zone buffer, which is “all land and water surface between the critical stream zone buffer area boundary of thirty (30) feet and one hundred fifty (150) feet from centerline or thalweg of the perennial stream.” The applicant has indicated that the removal of vegetation is allowed per 418.20(7), which states: “Landscape improvements and maintenance of native vegetation is allowed within an established critical stream zone buffer area including the pruning of trees and the removal of dead vegetation and debris. Ornamental landscaping that would require fertilizer or pesticide applications for growth and maintenance is not permitted within the critical stream buffer zone area.”

The SUP is the mechanism to access the work done on the site, to correct the cited violation, and provide specific direction to resolve the violation. Various local, state and federal departments and agencies have been requested to review the application and provide the appropriate corrections as needed to enable resolution of the violation.



Looking northwest at Thomas Creek – photo taken on 8.24.18



Looking southeast at Thomas Creek – photo taken on 9.12.18



Aerial Photo of Site

The applicant submitted a special use permit on July, 30 2018 stating that “trash, debris, dead, and dying vegetation” had been removed from the area around Thomas Creek. Staff visited the site on August 30th and observed the area on the east side of Thomas Creek which had been cleared of all vegetation except for a few trees. Also, an area had been cleared; primary along the property line. The property owner indicated it was cleared for the installation of a fence that would be constructed to prohibit trespassers. The property owner obtained a fence permit, WBLD18-106592, to install the fence but did not state on the application that any vegetation was being removed to install the fence (Exhibit C). However, the property owner stated that the areas needed to be cleared to get equipment in to install the fence. Since then, the property owner has also cleared the area on the west side of Thomas Creek of vegetation.

The site is now void of vegetation except for a few trees along the creek and a few pockets along the property line as the aerial photo above shows. The amount of grading on the site within the critical stream zone buffer area is approximately 11,121 square feet; for the area outside the critical stream zone, 10,926 square feet, and 7,871.7 square feet for the defensible space. The total area of disturbance is approximately 30,009.7 square feet for the two parcels and 1,072 cubic yards were graded for the fence installation. According to the Truckee Meadows Fire Protection District (TMFPD), defensible space is not required when no structures are located on the property.

The applicant’s engineer has provided the following calculations:

SURFACE DISTURBANCE TABLE		
AREA DISCIPTION	APN: 049-165-06	APN: 049-165-07
SURFACE DISTURBANCE FOR REMOVAL OF DEAD/DYING VEGETATION & DEBRIS WITHIN CRITICAL STREAM ZONE (SQ.FT.)	6,497.2	4,624.0
SURFACE DISTURBANCE FOR REMOVAL OF DEAD/DYING VEGETATION & DEBRIS OUTSIDE CRITICAL STREAM ZONE (SQ.FT.)	976.0	9,950.0
CUT - (CU.YD.) FOR PERIMETER FENCE INSTALLATION (PERMIT #WBLD18-106592)	449.0	87.0
FILL + (CU.YD.) FOR PERIMETER FENCE INSTALLATION (PERMIT #WBLD18-106592)	449.0	87.0
IMPORTED MATERIAL (CU.YD.)	0.0	0.0
SURFACE DISTURBANCE FOR DEFENSIBLE SPACE OF FENCE (SQ.FT.)	2,972.4	4,899.3

This special use permit is the mechanism by which County staff uses to help prevent erosion, improve the site, and to support the natural function of the stream. Conditions have been provided by technical experts who have the expertise in such matters. It is important to note that the grading on this property is currently a code enforcement matter and this special use permit is the tool by which Planning and Code Enforcement staff will use to ensure that the disturbed areas including the stream and riparian areas are restored to the extent possible.

South Truckee Meadows /Washoe Valley Citizen Advisory Board (STMWV CAB)

The proposed project was presented by Randy Soule at the regularly scheduled Citizen Advisory Board meeting on September 6, 2018. At the CAB meeting seven people spoke and had issues on the following items:

- All trees and vegetation along Thomas Creek have been removed whether it was healthy or not and this will increase flooding;
- Thomas Creek and the water that flows within it belongs to the community;
- This section of Thomas Creek is visible to other neighbors;
- The creek has been destroyed and fish and animal habitat have been destroyed;
- The area has not been cleaned-up it has been bulldozed and everything has been removed;
- The creek has been re-directed and re-aligned and a large pool has been created; and
- The property owner has created his own backyard water feature.

The CAB stated that the unpermitted work along this section of Thomas Creek needs immediate action and voted 4 in favor and 1 abstained for the special use permit (see Exhibit D for the CAB minutes).

Numerous phones calls have been received and an email. (See Exhibit E)

Reviewing Agencies

The following agencies received a copy of the project application for review and evaluation:

- Washoe County Community Services Department
 - Planning and Building Division
 - Engineering and Capital Projects Division
 - Parks and Open Spaces
- Washoe County Health District
 - Air Quality
 - Environmental Health Services Division
- Truckee Meadows Fire Protection District
- US Fish and Wildlife
- US Army Corps of Engineers
- Nevada Department of Water Resources
- Nevada Department of Environmental Protection
- Nevada Department of Wildlife
- Nevada Department of Parks
- Nevada Department of Water Resources
- Washoe-Storey Conservation District

Nine out of the fourteen above listed agencies/departments provided comments and/or recommended conditions of approval in response to their evaluation of the project application. Letters were received by the following (Exhibit F):

- US Army Corps of Engineers sent a letter to the applicant concerning work being in the waters of the United States of American without a permit and a request for information of the specific work that had been done. The applicant will need to provide the Corps information to access whether work was done below the high water mark, which is within their jurisdiction.
- Washoe-Storey Conservation District sent a letter with recommendations. The recommendations have been addressed and included by other agencies conditions and the District had no further conditions.
- Natural Resources Conservation Service (NRCS) could not provide conditions; there focus is working with farmers and ranchers on agricultural land. However, NRCS did provide guides on stream management practices.

A **summary** of each agency's recommended conditions of approval and their contact information is provided. The Conditions of Approval document is attached to this staff report and will be included with the Action Order (Exhibit G), if approved.

- Washoe County Planning and Building Division addressed revegetation and management standards for the project.
Contact: Julee Olander, 775.328.3627, jolander@washoecounty.us
- Washoe County Engineering and Capital Projects Division addressed the requirement for complete construction drawings, Stormwater Discharge Permit, a hydrology report, and technical standards for proposed roadways and drainage features associated with the project.

Contact: Walt West, 775.328.2310, wwest@washoecounty.us

- Washoe County Community Services Department-Parks addressed revegetation, working with other agencies and future access to the site from Washoe County property for the construction of a bridge.

Contact: Joanne Lowden, 775.328.2039, jlowden@washoecounty.us

- Nevada Division of Forestry (NDF) addressed revegetation and visual mitigation standards for the project.

Contact: Anna Higgins, 775.849.2500 ext. 237, ahiggins@forestry.nv.gov

- Nevada Department of Environmental Protection addressed revegetation and required permits.

Contact: Katrina Pascual, 775.687.9435, kpascual@ndep.nv.gov

- Nevada Department of Wildlife addressed the use of Best Management Practices on the site.

Contact: Mark Freese, 775.688.1145, markfreese@ndow.org**Staff Comment on Required Findings**

WCC Section 110.810.30, Article 810, *Special Use Permits*, requires that all of the following findings be made to the satisfaction of the Washoe County Board of Adjustment before granting approval of the request. Staff has completed an analysis of the special use permit application and has determined that the proposal is in compliance with the required findings as follows.

1. Consistency. That the proposed use is consistent with the action programs, policies, standards and maps of the Master Plan and the Southwest Area Plan.

Staff Comment: There are no specific Policies or Action Programs included in the Master Plan or Southwest Area Plan that prohibit grading. The approval of the special use permit will enable staff and other agencies to ensure the restoration of Thomas Creek, which is recognized in the Recreational Opportunities Plan of the South West Area Plan and Washoe County Development Code 110.418 as a significant hydrologic resource. Also, restoring the area that has been graded will meet goals and policies within the Conservation Element of the Master Plan.

2. Improvements. That adequate utilities, roadway improvements, sanitation, water supply, drainage, and other necessary facilities have been provided, the proposed improvements are properly related to existing and proposed roadways, and an adequate public facilities determination has been made in accordance with Division Seven.

Staff Comment: The special use permit is needed to support the restoration the area that has been graded without a permit. All improvements are existing and the only improvements that are needed are restoring the site to meet the Conditions of Approval.

3. Site Suitability. That the site is physically suitable for grading and for the intensity of such a development.

Staff Comment: The grading was done without a permit. The special use permit will restore the area that has been disturbed.

4. Issuance Not Detrimental. That issuance of the permit will not be significantly detrimental to the public health, safety or welfare; injurious to the property or improvements of adjacent properties; or detrimental to the character of the surrounding area.

Staff Comment: The issuance of the special use permit will help enable the restoration of the site so it will not be significantly detrimental to the public health, safety or welfare or injurious to the property or improvements of adjacent properties, or detrimental to the

character of the surrounding area. The reason for the special use permit is to restore an area that was graded without appropriate permits. Without restoring the area graded may be seen to be significantly detrimental to the public health, safety or welfare or injurious to the property or improvements of adjacent properties, or detrimental to the character of the surrounding area.

5. Effect on a Military Installation. Issuance of the permit will not have a detrimental effect on the location, purpose or mission of the military installation.

Staff Comment: *There is no military installation within the area of required notice for this special use permit.*

Recommendation

Those agencies which reviewed the application recommended conditions in support of approval of the project. Therefore, after a thorough analysis and review, Special Use Permit Case Number WSUP18-0017 is being recommended for approval with conditions. Staff offers the following motion for the Board of Adjustment's consideration.

Motion

I move that, after giving reasoned consideration to the information contained in the staff report and information received during the public hearing, the Washoe County Board of Adjustment approve, with conditions, Special Use Permit Case Number WSUP18-0017 for Randy & Kami Soule, having made all four findings in accordance with Washoe County Code Section 110.810.30:

1. Consistency. That the proposed use is consistent with the action programs, policies, standards and maps of the Master Plan and the Southwest Area Plan;
2. Improvements. That adequate utilities, roadway improvements, sanitation, water supply, drainage, and other necessary facilities have been provided, the proposed improvements are properly related to existing and proposed roadways, and an adequate public facilities determination has been made in accordance with Division Seven;
3. Site Suitability. That the site is physically suitable for Major Grading in a Critical Stream Zone Buffer Area, and for the intensity of such a development;
4. Issuance Not Detrimental. That issuance of the permit will not be significantly detrimental to the public health, safety or welfare; injurious to the property or improvements of adjacent properties; or detrimental to the character of the surrounding area.

Appeal Process

Board of Adjustment action will be effective 10 calendar days after the written decision is filed with the Secretary to the Board of Adjustment and mailed to the applicant, unless the action is appealed to the Washoe County Board of County Commissioners, in which case the outcome of the appeal shall be determined by the Washoe County Board of County Commissioners. Any appeal must be filed in writing with the Planning and Building Division within 10 calendar days from the date the written decision is filed with the Secretary to the Board of Adjustment and mailed to the applicant.

Applicant/Owner: Randy & Kami Soule
13390 Welcome Way
Reno, NV 89511
email: randy@encorenv.com



Conditions of Approval

Special Use Permit Case Number WSUP18-0017

The project approved under Special Use Permit Case Number WSUP18-0017 shall be carried out in accordance with the Conditions of Approval granted by the Board of Adjustment on October 4, 2018. Conditions of Approval are requirements placed on a permit or development by each reviewing agency. These Conditions of Approval may require submittal of documents, applications, fees, inspections, amendments to plans, and more. These conditions do not relieve the applicant of the obligation to obtain any other approvals and licenses from relevant authorities required under any other act.

Unless otherwise specified, all conditions related to the approval of this Special Use Permit shall be met or financial assurance must be provided to satisfy the conditions of approval prior to issuance of a grading or building permit. The agency responsible for determining compliance with a specific condition shall determine whether the condition must be fully completed or whether the applicant shall be offered the option of providing financial assurance. All agreements, easements, or other documentation required by these conditions shall have a copy filed with the County Engineer and the Planning and Building Division.

Compliance with the conditions of approval related to this Special Use Permit is the responsibility of the applicant, his/her successor in interest, and all owners, assignees, and occupants of the property and their successors in interest. Failure to comply with any of the conditions imposed in the approval of the Special Use Permit may result in the institution of revocation procedures.

Washoe County reserves the right to review and revise the conditions of approval related to this Special Use Permit should it be determined that a subsequent license or permit issued by Washoe County violates the intent of this approval.

For the purpose of conditions imposed by Washoe County, “may” is permissive and “shall” or “must” is mandatory.

Conditions of Approval are usually complied with at different stages of the proposed project. Those stages are typically:

- Prior to permit issuance (i.e., grading permits, building permits, etc.).
- Prior to obtaining a final inspection and/or a certificate of occupancy.
- Prior to the issuance of a business license or other permits/licenses.
- Some “Conditions of Approval” are referred to as “Operational Conditions.” These conditions must be continually complied with for the life of the project or business.

FOLLOWING ARE CONDITIONS OF APPROVAL REQUIRED BY THE REVIEWING AGENCIES. EACH CONDITION MUST BE MET TO THE SATISFACTION OF THE ISSUING AGENCY.

1. Washoe County Planning and Building Division

The following conditions are requirements of the Planning and Building Division, which shall be responsible for determining compliance with these conditions.

Contact Name: Julee Olander, (775)328-3627, jolander@washoecounty.us

- a. The applicant shall comply with all conditions of approval within 6 months from the date of approval by Washoe County. The applicant shall provide documentation showing how each of the conditions has been completed. Determination that each condition is complete shall be determined by the Planning and Building Division.
- b. A note shall be placed on all construction drawings and grading plans stating:

NOTE

Should any cairn or grave of a Native American be discovered during site development, work shall temporarily be halted at the specific site and the Sheriff's Office as well as the State Historic Preservation Office of the Department of Conservation and Natural Resources shall be immediately notified per NRS 383.170.

- c. The applicant shall return to the Board of Adjustment within prior to October 4, 2019 for a review to determine if all conditions are completed. The Board of Adjustment may direct Washoe County staff to pursue further enforcement actions based on non-completion of conditions.
- d. The applicant shall obtain a Grading Permit for all work on the subject site. At the discretion of the Director of the Planning and Building Division, permit fees may be increased by up to four times the standard applicable fees (not to exceed \$4,000) in accordance with WCC Section 100.133.3.1 for any work commenced prior to permit issuance.
- e. All trash and debris within the project area shall be removed.

2. Washoe County Engineering and Capital Projects Division

The following conditions are requirements of the Engineering Program of the Engineering and Capital Projects Division, which shall be responsible for determining compliance with these conditions.

Contact Name: Walt West, (775)328-2310, wwest@washoecounty.us

- a. A complete set of construction improvement drawings, including an on-site grading plan illustrating both completed and proposed grading, shall be submitted when applying for a building/grading permit. Grading shall comply with best management practices (BMP's) and shall include detailed plans for grading, site drainage, erosion control (including BMP locations and installation details), slope stabilization, and mosquito abatement. Placement or removal of any excavated materials shall be indicated on the grading plan. Silts shall be controlled on-site and not allowed onto adjacent properties or into Thomas Creek.
- b. Prior to final approval of a grading permit, the applicant shall obtain all required state and federal permits. The permits may include, but are not limited to, Nevada Division of Environmental Protection's Working in Waterways Permit, Construction Stormwater

Permit, 401 Water Quality Certification (or waiver), and U.S. Army Corps of Engineers 404 permit. Copies of all permits shall be provided to Washoe County Engineering Program.

- c. Prior to final approval of the grading permit, the applicant shall demonstrate that the Cease and Desist order or enforcement cases initiated by Nevada Division of Environmental Protection and the U.S. Army Corps of Engineers (SPK-2018-00705) have been or will be satisfied with the scope of work identified in the grading permit application and plans.
- d. The Truckee Meadows Regional Stormwater Quality Management Program Construction Permit Submittal Checklists and Inspection Fee shall be submitted with the grading permit application.
- e. A construction estimate shall be prepared by a licensed engineer for the work required to restore the disturbed areas and a financial assurance in the amount 120% of the estimated assessment, as approved by the Washoe County Engineering Program, shall be submitted as part of the grading permit application. The financial assurance shall be returned upon establishment of vegetation to the satisfaction of Washoe County Planning and Building Division.
- f. Cross-sections indicating cuts and fills shall be submitted when applying for a grading permit. Estimated total volumes shall be indicated on submitted plans.
- g. All disturbed areas left undeveloped for more than 30 days shall be treated with a dust palliative. Disturbed areas left undeveloped for more than 45 days shall be revegetated. Specifications for revegetation procedure and seed mix shall be prepared by a licensed landscape architect.
- h. No fencing is allowed across the drainage easement maintained by Washoe County. Grading permit plan submittal shall accurately reflect the alignment of fencing approved under the previously issued fence permit for the property(s).
- i. There are two areas of proposed grading along the west property line on steep sloping terrain. The application showing the grading of these areas will provide sufficient detail as to finished grades/slope of land proposed. All proposed grading shall comply with Washoe County Code Chapter 110, Article 438.
- j. The FEMA 100-year floodplain, floodway, and/or shaded X boundaries with associated flood elevations shall appear on the site plan to the satisfaction of the County Engineer. Building permits for structures and fill in these areas shall be in conformance with the Washoe County Code Article 416

3. Washoe County Parks and Open Spaces

The following conditions are requirements of Parks and Open Spaces, which shall be responsible for determining compliance with these conditions.

Contact Name: Joanne Lowden, (775)328-2039, jlowden@washoecounty.us

- a. The applicant shall develop and submit a restoration plan to Washoe County Park staff that includes revegetation with native riparian plant species and measures for erosion and weed control. Revegetation shall meet the requirements of Condition 5.

4. Nevada Division of Environmental Protection (NDEP)

The following conditions are requirements of the NDEP, which shall be responsible for determining compliance with these conditions.

Contact Name: Katrina Pascual, (775)687-9435, kpascual@ndep.nv.gov

- a. The applicant will obtain a Construction Stormwater Permit and a Working in Waterways permit.

5. Nevada Division of Forestry (NDF)

The following conditions are requirements of the NDF, which shall be responsible for determining compliance with these conditions.

Contact Name: Anna Higgins, (775)849-2500 ext. 237, ahiggins@forestry.nv.gov

- a. The applicant will revegetate the site with native vegetation to the satisfaction of the Nevada Division of Forestry (NDF).
- b. The amounts of shrub and tree plantings and the pounds per acre of the seed mix will be defined by NDF.

6. Nevada Division of Wildlife (NDOW)

The following conditions are requirements of the NDOW, which shall be responsible for determining compliance with these conditions.

Contact Name: Mark Freese, (775)688-1145, markfreese@ndow.org

- a. The applicant shall use Best Management Practices for any dirt work (e.g. sediment control devices).
- b. The applicant shall reseed to minimize erosion issues and install sediment control devices on the exposed banks at water line to help vegetation establish.

*** End of Conditions ***

From: [Chism, Johnna](#)
To: [Olander, Julee](#)
Subject: FW: 13430 Welcome Way post meeting pictures and agreement
Date: Thursday, September 20, 2018 8:41:12 AM
Attachments: [image001.png](#)
[image002.png](#)
[image003.png](#)
[image004.png](#)
[image005.png](#)
[Binder1.pdf](#)

From: Farmer, Brian
Sent: Friday, June 22, 2018 2:19 PM
To: Randy@encorenv.com; Hauenstein, Mojra
Cc: Chism, Johnna; Webb, Bob
Subject: 13430 Welcome Way post meeting pictures and agreement

This email is to serve as a reminder of what was agreed at the June 21st meeting regarding the work being completed at Mr. Soule's properties on Welcome Way:

1. Mr. Soule and myself will meet on property to photograph the current condition of the area near Thomas Creek. We met this morning and I have attached the 17 photographs of the work area, due to the size four separate emails will be sent .
2. Mr. Soule will remove the vegetation that was excavated from the land near the creek, prep the soil to be seeded and spray/plant meadow grass seed within the designated area.
3. Mr. Soule will remove the "manmade" debris that currently sits in the creek. A picture of the debris is the first pic in the attached "Binder3"
4. Mr. Soule will meet with an assigned Planner to go over and complete the Special Use Permit application for the work completed on his property as it relates to the area near Thomas Creek.



Brian Farmer
Code Enforcement Officer II, Planning and Building Division | Community Services
Department
bfarmer@washoecounty.us | Office: 775.328.2312
1001 E. Ninth St., Bldg A, Reno, NV 89512





WASHOE COUNTY
Department of Building & Safety
"Dedicated to Excellence in Public Service"
BUILDING PERMIT
INSPECTION LINE (775) 325-8000
www.washoecounty.us/building



(775) 328-2020
 (775) 328-8132 FAX

Address: 13410 WELCOME WAY
 Location:
 Parcel No: 049-165-06
 Zoning:
 Area: SOUTHWEST

Permit No: **WBLD18-106592**
 Permit Type: Residential Fences, Retaining Walls & Barriers
 Type: Fences
 Occupancy:

Applied: 07/25/2018
 Issued: 07/26/2018
 Status: Issued
 Expire: 01/25/2020
 Use Code:

OWNER SOULE, RANDY & KAMI
 13390 WELCOME WAY
 RENO, NV 89511
 Phone 1:
 Phone 2:
 Email:

CONTRACTOR ENCORE D E C LLC
 14830 KIVETT LN
 RENO, NV 89521
 License: 0076757
 Phone 1:
 Phone 2:
 Phone 3:
 Email:

CONTACT RANDY SOULE
 13390 WELCOME WAY
 RENO, NV 89511
 Phone 1: 775-762-2797
 Phone 2:
 Phone 3:
 Email: randy@encorenv.com

Permit Description: 1,530 LINEAL FEET OF PERIMETER FENCING CROSSING TWO PARCELS, 049-165-06 AND 049-165-07 / 60 FEET OF WHICH CROSSES A CRITICAL STREAM ZONE BUFFER / VARIED HEIGHTS WITH 6 FOOT MAX / INCLUDES VINYL, BARB WIRE AND RHINO CONCRETE FENCING

Valuation: \$480.00

Occupancy	Type	Factor	Sq Feet	Valuation
OR Fence	-	8.00	60	\$480.00
Totals			60	\$480.00

FEES:	Building Fee:	\$45.00	Renewal Fee:	\$0.00	TOTAL FEES:	\$77.25
	Reinspection Fee:	\$0.00	Impact Fee:	\$0.00	PAYMENTS:	\$77.25
	Water Resources Fee:	\$0.00	Violation Fee:	\$0.00	BALANCE DUE:	\$0.00
	Plan Check Fee:	\$29.25	Regional Tech Fee:	\$0.00		
	Move/Alter Fee:	\$0.00	Other Fee:	\$3.00		
					RRIF & Health Fees to be determined	

Signature:

Permission is hereby granted to do the work for the building described in this application, in accordance with the Rules, Regulations and Ordinances of the County of Washoe, along with the plans and specifications filed herewith.

IMPORTANT TIME DEADLINES: (Initial)

I UNDERSTAND THAT FINAL INSPECTION OR RENEWAL OF THIS PERMIT MUST BE MADE PRIOR TO THE EXPIRATION DATE OR NEW PLANS MUST BE SUBMITTED AND PERMIT FEES PAID PRIOR TO FINAL INSPECTION. PERMITS EXPIRE 18 MONTHS FROM THE DATE OF ISSUE, WITH NO GRACE PERIOD. IF THE DATE OF EXPIRATION FALLS ON A WEEKEND OR HOLIDAY, THE PERMIT MUST BE RENEWED ON THE LAST BUSINESS DAY PRIOR TO THE EXPIRATION. I UNDERSTAND THIS IS THE ONLY NOTICE I WILL RECEIVE FOR RENEWAL OF THE PERMIT AND KEEPING THE PERMIT RENEWED AND IN A VALID STATUS IS MY RESPONSIBILITY.

DISCLAIMERS: INDEMNIFICATION: ACKNOWLEDGMENTS BY PERMITTEE: (Initial)

I UNDERSTAND THAT THE INSPECTIONS PROVIDED BY WASHOE COUNTY ARE VERY LIMITED AND DO NOT COVER ALL OF THE WORK PERFORMED UNDER THE AUTHORITY OF THIS PERMIT. THE INSPECTIONS ARE OCCASIONAL SPOT CHECKS, MUCH LIKE AN AUDIT; THEREFORE MANY PARTS OF THE WORK ARE NOT INSPECTED. IF MORE INSPECTION IS DESIRED, A PRIVATE INSPECTOR MUST BE HIRED BY THE PERMITTEE. NEITHER THE INSPECTIONS BY THE COUNTY NOR THE CERTIFICATE OF OCCUPANCY CONSTITUTE A REPRESENTATION BY THE COUNTY THAT THE WORK WAS INSPECTED OR THAT THE WORK COMPLIES WITH COUNTY ORDINANCES.

I HEREBY AGREE TO DEFEND AND TO SAVE, INDEMNIFY AND KEEP HARMLESS THE COUNTY OF WASHOE AND ITS OFFICERS, EMPLOYEES AND AGENTS AGAINST ALL LIABILITIES, JUDGEMENTS, COSTS AND EXPENSES WHICH MAY ACCRUE AGAINST THE COUNTY IN CONSEQUENCE OF GRANTING OF THIS PERMIT OR CERTIFICATE OF OCCUPANCY, IN CONSEQUENCE OF THE COUNTY'S OWN NEGLIGENCE OR ITS OTHERS ACTS OR OMISSIONS WITH RESPECT TO THIS PERMIT OR A CERTIFICATE OF OCCUPANCY, OR IN CONSEQUENCE OF THE USE OR OCCUPANCY OF ANY WORK, SIDEWALK, SUB-SIDEWALK OR STREET, OR OTHERWISE BY VIRTUE THEREOF, AND WILL IN ALL THINGS STRICTLY COMPLY WITH THE CONDITIONS OF THIS PERMIT AND PROVISIONS OF THE RULES, REGULATIONS AND ORDINANCE OF THE COUNTY OF WASHOE.



Washoe County Department of Building & Safety

1001 E. Ninth Street
P.O. Box 11130
Reno, NV 89520-0027
Phone (775) 328-2020

FAX (775) 328-6132 or FAX (775) 325-8016
www.washoecounty.us/bldgsafety



MISC
Permit # 18-106592

RESIDENTIAL/REMODEL

BUILDING PERMIT APPLICATION

Parcel Number: <u>049-165-07</u> <u>049-165-06</u> Address: <u>13410 + 13430 WELCOME WAY</u>	
Unit No. _____	
Owner Information:	Owner/Builder Permit? <input type="radio"/> Yes <input checked="" type="radio"/> No
Name: <u>RANDY SOULE</u>	Phone No: <u>762-2797</u>
Address: <u>13390 WELCOME WAY</u>	
Contractor Information:	
General Contractor: <u>ENCORE DEC</u>	Contact Name: <u>RANDY SOULE</u>
Address: <u>14830 KIVETT LANE - RENO, NV 89521</u>	
Phone: <u>762-2797</u>	Fax: _____
Nevada License No.: <u>0076757</u>	County Business License No.: <u>W039937A-LIC</u>
Design Professional Information:	
Architect's Name: <u>J.P ENGINEERING - KATE SOLARO</u>	Phone No.: <u>852-2387</u>
Email: <u>KATE@JPENGNV.COM</u>	Fax No.: _____
Engineer's Name: <u>KATE SOLARO</u>	Phone: <u>KATE SOLARO SAME</u>
Email: <u>SAME</u>	Fax No.: _____
Person to contact regarding the permit:	
Name: <u>RANDY SOULE</u>	Phone No.: <u>762-2797</u>
Email: <u>RANDY@ENCORENV.COM</u>	Fax No.: _____

Permit # 18-106592

Project Information:

(Complete Applicable Items)

Contract Price: \$31,000
 Total Project Sq. Footage: _____
 New Living Area Sq. Footage: _____
 Remodel Sq. Footage: _____
 Current Living Area Sq. Footage: _____
 New Garage Sq. Footage: _____
 Current Garage Sq. Footage: _____
 New Covered Deck and Porch Sq. Footage: _____
 New Deck and Porch Sq. Footage: _____
 Patio Cover or Sunroom Sq. Footage: _____
 Shed Sq. Footage: _____
 Fence Lineal Footage: - 1530'

Water Well: _____
 Septic System: _____
 Architectural Committee _____

Yes No
 Yes No
 Yes No

Description of Work:

INSTALL NEW PROPERTY FENCES PER
 DRAWINGS C1 & C2

Applicant (print) RANDY SOULE Date: 7/24/18

Signature Randy Soule

FOR OFFICE USE ONLY

RTC:

New Single Family Home Accessory Dwelling (second kitchen on site) N/A

Park Tax Determination:

New Dwelling on Vacant Lot Replace Existing Dwelling Built Prior To 1974 N/A

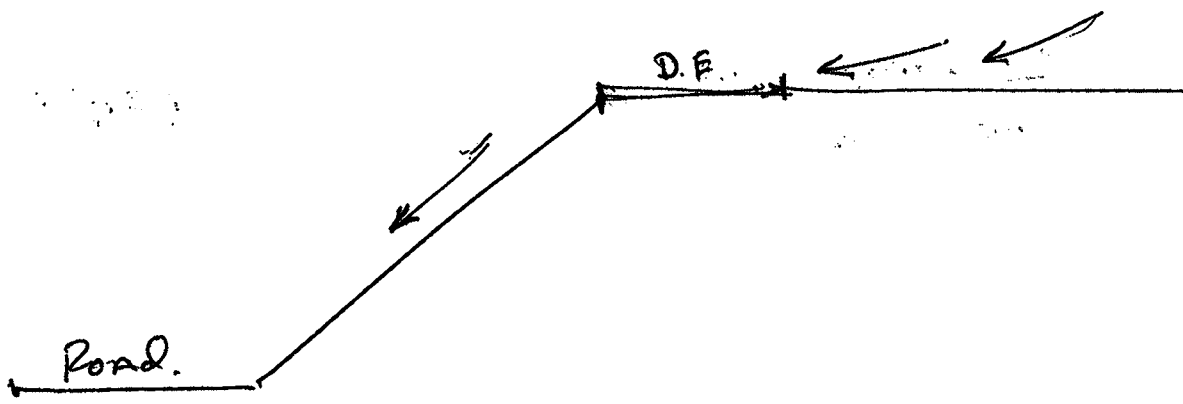
Building Code Information:

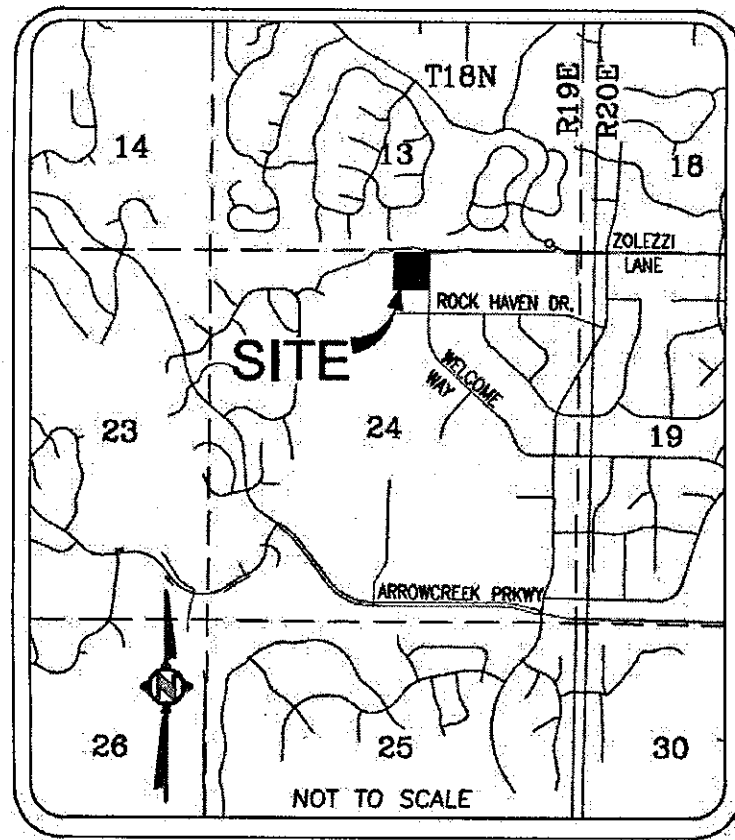
Edition of Code: _____ Building Code used: _____

Type of Construction: Wood Framing ~ Steel Framing Occupancy Use _____

Occupancy Group: Single Family Home ~ Townhouse ~ Duplex

358-1200
AIDEN

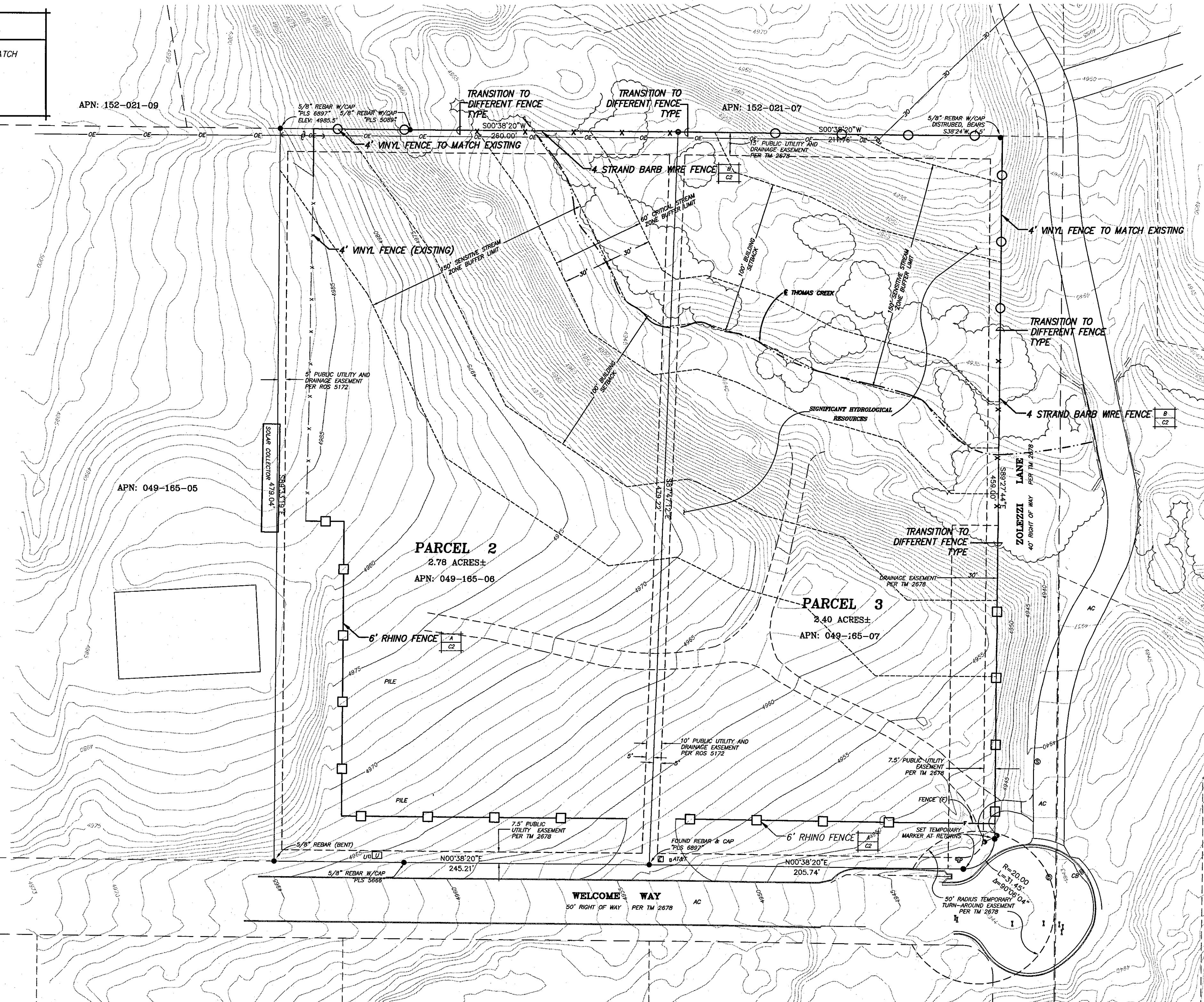




VICINITY MAP

GENERAL NOTES

1. TOTAL LENGTH OF NEW 4' VINYL FENCE IS +/- 417 LINEAR FEET. CONTRACTOR SHALL MATCH EXISTING.
2. TOTAL LENGTH OF NEW 6' RHINO FENCE IS +/- 800 LINEAR FEET.
3. TOTAL LENGTH OF NEW 4 STRAND BARB WIRE FENCE IS +/- 330 LINEAR FEET.



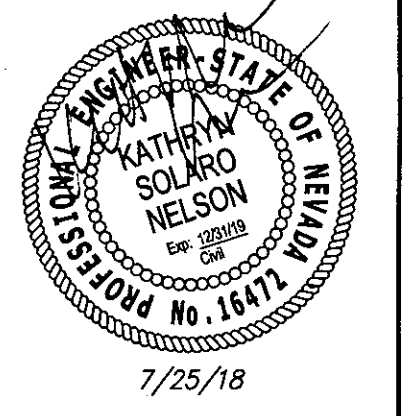
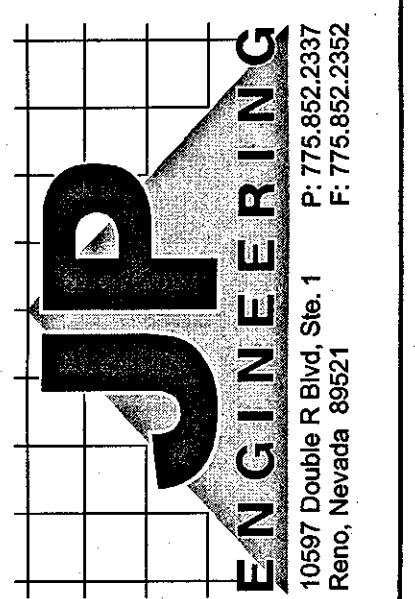
A SITE PLAN
 C1 SCALE: 1" = 40'-0"

LEGEND

- X — FENCE (EXISTING)
- FENCE 4' VINYL
- X — FENCE 4 STRAND BARB WIRE
- FENCE 6' RHINO
- F — FENCE (FUTURE)

18-106592

WASHOE COUNTY BUILDING DEPT.
 OFFICE COPY

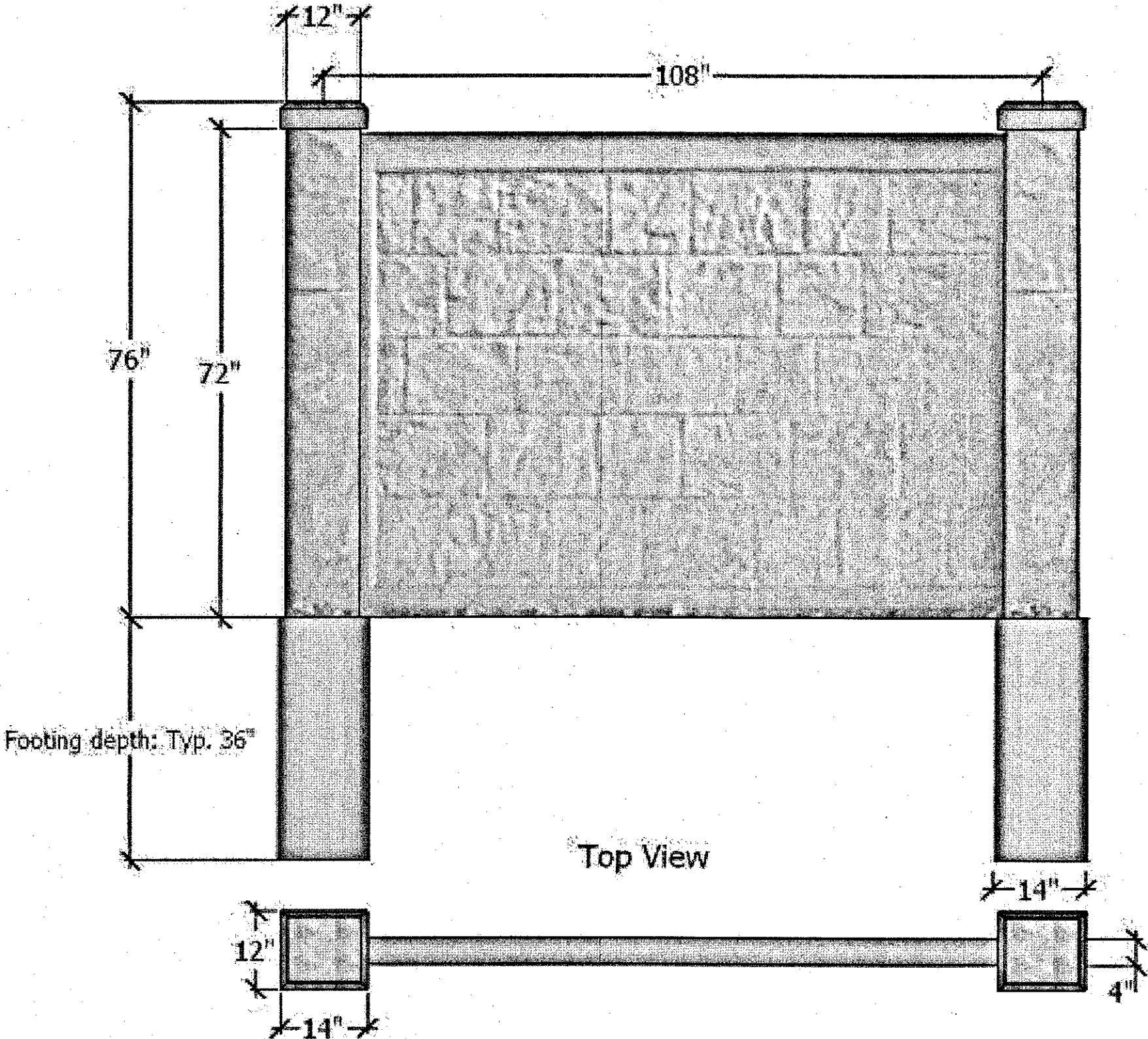


FENCE PERMIT APPLICATION
SOULE PROPERTY
 NORTHWEST END OF WELCOME WAY
 APN: 049-165-06 & 049-165-07
 RENO, NEVADA 89511

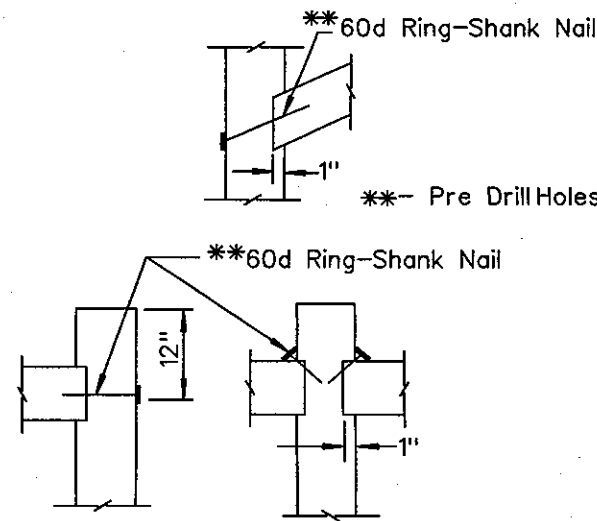
REVISIONS	
SHEET TITLE	
SITE PLAN	
DRAWN:	KN
CHECKED:	KN
DATE:	7/16/18
JOB NUMBER:	JP #18094

C1

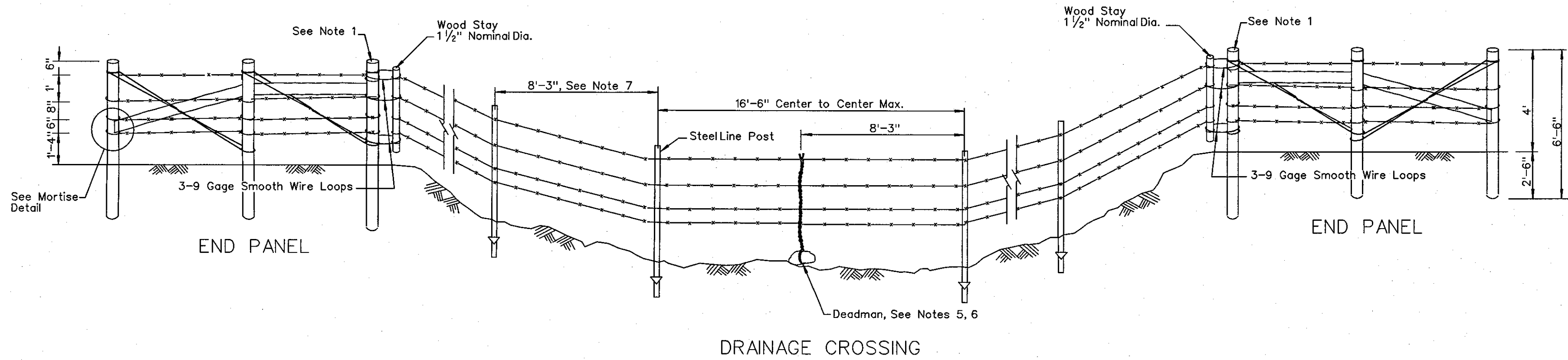
RhinoRock Concrete Fence Detail



A	6' RHINO FENCE
C2	SCALE: NOT TO SCALE



MORTISE DETAIL



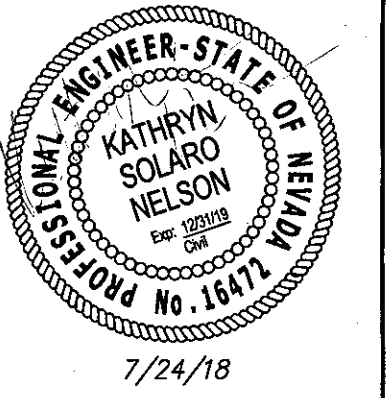
DRAINAGE CROSSING

B	4 STRAND BARB WIRE FENCE
C2	SCALE: NOT TO SCALE

BARB WIRE FENCE GENERAL NOTES

- HINGE POST SHALL BE 8 FEET IN LENGTH AND SHALL BE BURIED 3 FEET IN GROUND.
- NOT USED.
- WIRES ARE TO BE TIED OFF AT STRETCH POINTS. WRAP AND SPLICE TO SELF WITH AT LEAST 4 TURNS AT OPPOSITE END OF PANELS.
- WOOD POSTS SHALL BE 6 INCH NOMINAL DIAMETER.
- ADD ADDITIONAL STRAND OF BARBED WIRE AND/OR A ROCK DEADMAN (MINIMUM WEIGHT 50 LB.) WHEN SPACE BETWEEN BOTTOM WIRE AND GROUND EXCEEDS 20 INCHES.
- STEEL POST DEADMAN DRIVEN APPROXIMATELY 3 FEET INTO GROUND MAY BE USED IN LIEU OF ROCK DEADMAN.
- STEEL LINE POSTS AT 8 FEET 3 INCH SPACING TO MAINTAIN BOTTOM WIRE CLEARANCE.

WASHOE COUNTY BUILDING DEPT.
OFFICE COPY



FENCE PERMIT APPLICATION
SOULE PROPERTY
NORTHWEST END OF WELCOME WAY
APN: 049-165-06 & 049-165-07
RENO, NEVADA 89511

REVISIONS

SHEET TITLE
DETAILS

DRAWN:	KN
CHECKED:	KN
DATE:	7/16/18
JOB NUMBER:	JP #18094

C2



South Truckee Meadows/Washoe Valley Citizen Advisory Board

DRAFT: Approval of these draft minutes, or any changes to the draft minutes, will be reflected in writing in the next meeting minutes and/or in the minutes of any future meeting where changes to these minutes are approved by the CAB. Minutes of the regular meeting of the South Truckee Meadows/Washoe Valley Citizen Advisory Board held September 6, 2018 6:00 p.m. the South Valleys Library at 15650A Wedge Parkway, Reno, Nevada.

1. *CALL TO ORDER/ DETERMINATION OF QUORUM - Meeting was called to order at by Steven Kelly at 6:00 p.m.

Member Present: Jim Rummings, Steven Kelly, Jason Katz, Patricia Phillips, Tom Burkhart (alternate). A quorum was determined.

Absent: Kimberly Rossiter (excused)

2. *PLEDGE OF ALLEGIANCE - Steven Kelly led the Pledge of Allegiance.

3. *PUBLIC COMMENT - No public comments were made.

4. APPROVAL OF AGENDA FOR THE MEETING OF SEPTEMBER 6, 2018 (for Possible Action) – Patricia Phillips moved to approve the agenda for **SEPTEMBER 6, 2018**. Jim Rummings seconded the motion to approve the agenda for **SEPTEMBER 6, 2018**. Motion carried unanimously.

5. APPROVAL OF THE MINUTES FOR THE MEETING OF AUGUST 2, 2018 (for Possible Action) – Jim Rummings moved to approve the meeting minutes for **AUGUST 2, 2018**. Jason Katz seconded the motion to approve the meeting minutes for **AUGUST 2, 2018**. Motion carried unanimously.

6. DEVELOPMENT PROJECTS– The project description is provided below with links to the application or you may visit the Planning and Building Division website and select the Application Submittals page:

https://www.washoecounty.us/csd/planning_and_development/index.php.

6.A. Special Use Permit Case Number WSUP18-0007 (T-Mobile Lighthouse Baptist Church) – Request for community feedback, discussion and possible action to forward community and Citizen Advisory Board comments to Washoe County staff on a request for the construction of a new wireless cellular facility consisting of a 55-foot high tower utilizing a stealth design disguised as a pine tree (also known as a monopine) with faux branches screening the proposed antenna panels. The associated 30' x 30' (900 s.f.) lease area and equipment cabinets will be enclosed by a 7 foot concrete block wall, which will be treated with a stucco finish and painted to match the existing church building on the subject property. (for Possible Action)

- Applicant/Property Owner: T-Mobile/ Lighthouse Baptist Church Reno
- Location: 5350 Pembroke Drive, 1/3 mile east of McCarran Blvd
- Assessor's Parcel Number: 021-140-20
- Staff: Chad Giesinger, Senior Planner, 775-328-3626; cgiesinger@washoecounty.us
- Reviewing Body: Tentatively scheduled for the Board of Adjustment October 4, 2018

Karen Lynard, T-Mobile representative, provided a presentation:

She said they have presented before this CAB prior for the same request; however, as they progressed through the process, they realized they needed a re-design, and moved away from the 3-legged design. There

was concern with lighting for that proposal, and are now proposing a 55 foot monopine with a structure to cover the equipment.

Jason Katz asked about the location. Karen said it's proposed to be moved to the back of the church. It's closer to those residents in the rear of the church. It's the same height as previous proposed structure.

Tom Judy said he spoke about this item before. He said he doesn't object to tower, but it's out of place given nothing is as high in the area. If FAA requires a flashing light, the neighborhood will object. He said he doesn't want anything to obstruct the views, but he said he doesn't object to the tower itself.

Karen said we don't have a determination from FAA regarding lighting yet. She said there is different lighting proposed, and we don't know that determination of requirements yet.

Patricia Phillips asked if there are any trees in the area of the same height. Karen said not the same, but similar. Karen said the trees are approximately 35 feet tall, not 55 feet.

Jim Rummings asked if there is unlimited amount of application submissions for an application. Trevor Lloyd said if there is a denial without prejudice, they have to wait a year, but if they are making a change to their original application, they may make those changes.

MOTION: Jim Rummings moved to recommend approval of Special Use Permit Case Number WSUP18-0007 (T-Mobile Lighthouse Baptist Church). Jason katz seconded the motion to recommend approval. Motion passed unanimously.

6.B. Special Use Permit Case Number WSUP18-0017 (Soule Grading) – Request for community feedback, discussion and possible action to forward community and Citizen Advisory Board comments to Washoe County staff on a request for a special use permit for grading, which was performed without the required permit(s) within a significant hydrological resource (SHR), by grading and removing vegetation within the Thomas Creek Critical Stream Zone. (for Possible Action)

- Applicant/Property Owner: Randal and Kami Soule
- Location: 13410 and 13430 Welcome Way
- Assessor's Parcel Number(s): 049-165-06 and 049-165-07
- Staff: Julee Olander, Planner, 775-328-3627; jolander@washoecounty.us
- Reviewing Body: Tentatively scheduled for the Board of Adjustment October 4, 2018

Trevor Lloyd said this request is to bring illegal grading into compliance. He said we were notified two months ago of this grading. They preformed illegal grading on two parcels on sensitive stream zones. The State, EPA, US Forestry, and Corp of Engineers are interested in this grading. Special Use Permit is to ensure the land is brought back to natural state as much as possible.

Jason Katz asked why we are even hearing this SUP since it's already done. Trevor said through compliance, a permit is required for an application for grading with the ability to impose conditions. After the fact, this is the mechanism. Jason asked if this is a violation or an enforcement issue. Trevor explained this is in the code enforcement process and this is part of the process to get a special use permit. Steve Kelly said a permit is the tool to enforce the compliance. Jason said what if it's not granted. Trevor said the SUP will allow for special conditions to be imposed which is part of the code enforcement process.

Jason Katz said he has practice law for 40 years, and he said he has never heard of getting a permit after the fact. Jason said someone violated code and regulation, and the County doesn't have mechanism. Trevor said

we do; it's under the code enforcement right now, and it has to be brought into compliance with SUP, conditions, and feedback from agencies.

Tom Burkhart asked if it's possible to restore to original state. Trevor said not 100% to native condition, but this is the process to get it back as close to natural state. State and County agencies are involved.

Randy Soule, Applicant/Owner said there are two sides to every story. He said there is a code, and there is an argument about his right to do what he is doing under the code. He said he and his wife have owned the property for over 20 years. The property has been damaged to flooding over the years. He said there has been homeless people living on his property; they took lumber and pallets from the home and lived on his property. He said they had them removed. The floods washed the lumber and pallets out. He said he has allowed the public to walk through the open space, and he hasn't put up any trespassing signs. He said they are attempting to clean up the area by removing garbage and overgrowth and replanting with vegetation that can be better managed. He said he wants the trespassing to stop from homeless and kids. He said there may be differing opinion on what he is doing on his property, but the intent is to correct the area, replant it in a manageable manner to prevent trespassing. He said he will listen to the public on how they want it restored; he has been working with the County for a more manageable property. It cannot be what it was; it was flooding, damaged, risk to downstream properties, and trespassing. He said he is trying to do something productive to make it right. He said he is working with the Parks Department to make the path continue down the corridor. He said he has been following code compliance and is allowed to do what he has done.

Jason Katz said he is unclear of what he did. Randy Soule said he removed the vegetation, overgrowth, garbage, lumber, pallet, and garbage. Randy said grading is defined as removing vegetation, disrupting a certain square footage which he said he did not; he didn't move soil. He said he acquired permit for the perimeter fence for six acres which has nothing to do with this application.

Public Comment:

Lyn Mundt, Whites Creek resident on a creek, said she was instrumental in putting together the hydrological ordinance. There were many stakeholders interested in creeks within the wildlife corridor. The undisturbed stream zone provides flood protection. Thomas Creek is heavily vegetated. She showed pictures of the applicants property where vegetation had been removed. She said she spoke with planning department. She said he needs to restore this property which requires this special use permit. SUP would provide special instructions on how to bring it back to its natural state so it can provide the resources that streams provide. Please approve this application so proper conditions can be applied, and the stream can be put back to the best possible condition.

Brad Kern, lives on high ground on Whites Creek, said according to AB 396, everyone owns that creek. He said there are picture of what happen. He said there are YouTube videos of Randy destroying the creek. Brad said Nevada ranks #5 in disappearance of creeks. Brad said Randy wants to put seed and fertilizer which is a killer. It's made out of ammonium nitrate - there will be poisons. He will use seed from china and introduce a foreign substance. Brad said he can hear Randy's tractor; he's killing plants and fish. It will take 100 years to bring it back. He said he doesn't support the permit, it's invalid.

Andrea Green said she overlooks Randy's property. She provided pictures of the subject property from her property. He took out an aspen grove. She showed the no building setback, and showed what it looks like now. It's all been graded. He misrepresented himself in the SUP; he took out 30 trees. It can be seen by several properties in the area. She asked if SUP is approved, can it be enforced that he has to repair the stream at a later date. She said what has been done is done. He was in the creek with the excavator on Labor Day after he

was asked to stop. This is federal law not to enter any creeks. He distributed the rocks and disrupted how it flows. It will be a muddy mess. She said she has cleaned up after the teens who would party down on his property. She said the special use permit doesn't help; he has done what he already done.

Mike Block said this property has been for sale off and on for years. He read the property listing descriptions – 'catch trout out of your back yard.' He said the 'improvements' being made are supposed to help with the property value. A video drone of the property was made by a real estate agent prior to disturbance with trees. You can see it online. Mike said he has video from today, and it's all bare ground. He said he doesn't agree with SUP. Don't give him approval for what he did.

Jim Sundali said he lives below the disturbed stream. He said he didn't know anyone owned it; he thanked Randy for letting them use the land. This is not yard clean up as stated in the application. He asked what is the best way to restore the land and stream. He said it may require the special use permit to accomplish that.

Ken Green agreed with Mr. Soule said he is entitled what he can do as long as it complies with the law. He thanked Randy for the opportunity to walk on the trail. He said he didn't see any trash. It's a gorgeous trail. its no longer accessible. He showed a series of pictures taken by Mike Block. He said he doesn't support SUP application; it's untrue; it's false. It talks about restoring, but it doesn't address west side of the channel. He crossed the channel. It's devoid of vegetation on both sides. He didn't comply with SUP; he didn't file application to begin with. Information is false. He said Mr. Soule continued to work on property with no regard to application is approved or not. He showed sedimentation. You cannot un-grade the property. He cannot bring it back to natural state. The channel was gorgeous. Randy went about it without a permit, crossed Thomas creek; he violated Army Corp Regulations. He said the fence was approved around Mr. Soule property. He said debris will back up on the fence and affect the flows.

Diane Novotak said she lives next to Andrea Green, and has been watching what Mr. Soule has done. She agreed with Mr. Green. Mr. Soule started work at the end of May. She said she took videos May until now of the grading work; videos have been sent to Mr. Farmer with Washoe County Code Enforcement. Mr. Soule doesn't have proper permits. He has driven down the middle of the stream to take out cottonwood, aspen and other trees that were anchor to stream. He has altered the course of the stream. He has placed big boulders and small boulders which has created a water feature out of Thomas Creek. She asked for the Arborist reports about dead trees that were removed. The person who destroyed it shouldn't be allowed to fix it. She said she doesn't agree with the special use permit.

Jason Katz asked if SUP isn't granted what is course to bring it back to state. Julee said there is a threshold of grading that triggers a SUP, and you have to meet specific conditions. She said the SUP is the only means to repair illegal grading; the only mechanism to allow us to address this issue. With grading, it's through the Special Use Permit process that allows the County to have teeth. Division of Forestry has been part of the process. It will be required to be put back in the stream area.

Steven Kelly said we aren't condoning what has been done, but it is mechanism to correct it.

Julee said this will go before the Board of Adjustment. She deemed the application incomplete with insufficient information regarding area disturbed with square footage calculation to show it met the thresholds. The applicant has now disturbed the west side. The fence was approved, but doesn't allow him to grade a road to bring in the fence equipment. It's not complete since he continues to do work after his original application. She said she is still waiting on information. Conditions to re-vegetate will be determined by

Division of Forestry or EPA. Staff is responsible to make sure the conditions are met with review and inspection, and that is why SUP is critical.

Trevor Lloyd said the application isn't complete, but we want restoration to happen as soon as possible. He said they depend and rely on experts of NDEP, US Forestry. The purpose of Special Use Permit is to get us closer to restoration.

Jason Katz said the applicant doesn't agree with County; he is willing to litigate it. Jason asked if the applicant is going to follow through with meeting conditions. Trevor said he will be under enforcement, and SUP will ensure specialists are looking at condition and making sure it's being met.

Jason Katz asked if there is any reason for an injunctive relieve for this situation. Trevor said this is the mechanism. Jason said they continue to break the law. Trevor said if he cannot do what is required; it may become a legal matter.

Patricia Phillip said if the stream begins in the Sierras then there are different water rights. Residents have water rights. She asked if the state engineer involved. Julee said state water rights authority is involved. Pat said this may go before the Federal Water Master and the State. Trevor said they will confirm if it requires the State and Federal Water Master.

Jim Rummings said immediate action needs to happen before flooding. Put emotions aside to make sure the stream is preserved.

Pat said she has worked with the Federal Water Master and State Engineer and they need to be involved. Trevor said they will be involved.

Ken Greene said the application is not complete. We need a reliable application. Steve said that is what Julee is trying to get. Steve said he has some level of confidence this will be put in the right direction.

MOTION: Steven Kelly moved to recommended approval and to take into consideration the concerns voiced to be used as the foundation for conditions that have to be met. Patricia Phillips seconded. Jim Rummings abstained. Motion passed 4 to 1 in favor of the Special Use Permit Case Number WSUP18-0017 (Soule Grading).

7. *CHAIRMAN/BOARD MEMBER ITEMS - This item is limited to announcements by CAB members. (This item is for information only and no action will be taken by the CAB).

Patricia Phillips said Huffaker (going west) the road was widened but then it narrows at the lake irrigation ditch. Cars, trucks, and trailers cannot turn from Huffaker to Damonte because it is too narrow. There are accidents. It's where city meets the county. She said it needs to be widened again.

8. *PUBLIC COMMENT –

Shannon Windle submitted a written statement. President of Hidden Valley Wild Horse Protection Fund. Reno Public Works, Reno Transit Commission, Reno City Council, Washoe County Animal Control, Reno Police Department, Washoe County Planning Department, University of Nevada, Storey County Sheriff's Department, Lyon County Commissioners, Nevada Department of Transportation, Damonte Ranch Drainage District, Washoe County Citizen Advisory Board, Washoe County Sheriff's Department, Lyon County Sheriff's

Department, Department of Motor Vehicles, Various property developers, Truckee Meadows Water Authority, City of Reno Neighborhood Advisory Board. These are just some of the local and state agencies with which our united local are wild horse groups have successfully reached out to and created good, positive, working relationship.

In addition, just over a year ago our wild horses were granted 685 acre parcel of land just to the north of Spanish Springs where we are building a wild horse sanctuary, adoption center, and visitor center. We hope to have horses on site in the next few months and open for visitors in the spring.

Of true excitement, is the upcoming Virginia Range Mustangs special license plate. A portion of the proceeds will be going to on the range projects and public safety projects such as fencing, cattle guards, and signage. Once the license plate is active (or for sale) in the DMV we would like to request to be added to the agenda for a future meeting to discuss the needs of the community from the CAB perspective and if there are any projects we can develop together in the interest of the public safety.

ADJOURNMENT – the meeting adjourned at 7:20 p.m.

Number of CAB members present: 5

Number of Public Present: 10

Presence of Elected Officials: 0

Number of staff present: 2

From: conresllc
To: [Olander, Julee](#)
Subject: Soule Grading (WSUP18-0017)
Date: Monday, September 24, 2018 11:42:07 AM

Julee Olander

This neighbor was deceitful in his previous special use permit on his out building and he did not conform to that permit, so it's no surprise to any of us, his neighbors, that he did this.

He is a multi-millionaire and obviously thinks he can do whatever he wants with his land. The natural beauty of the land is now completely destroyed and looks like his own commercial storage lot for his excavating equipment.

His mentality will never change no matter the fine you give him... so a fine would be senseless. He should be required to re-vegetate the land with mature plants, not just hydroseed! This is the only way to undo the damage he has done. Anything less will take 30 years to regrow the natural vegetation...

Thank You

From: Ken Greene
To: [Olander, Julee; jstone@ndep.nv.gov](mailto:jstone@ndep.nv.gov)
Subject: Case Number: WSUP18-0017 Soule Grading
Date: Wednesday, August 29, 2018 10:08:51 PM

Hi there,

I am an interested citizen and concerned neighbor of Mr. Soule and the subject case number. Review of the SUP Application. There was a site meeting Friday, June 22, 2018 - after at least some of the grubbing, clearing and tree removal had occurred (started during the May 2018 time frame) - much of which clearly occurred in the 150' sensitive stream zone buffer limit and 50' critical stream zone buffer limit shown on the site plan attached to the subject SUP Application - with none of the specified/required BMPs installed. See a couple of attached photos showing site conditions following the July 21 storm event - releasing significant sediment/debris into Thomas Creek and the storm water system. Clearly what is described in the application (e.g., removal of ~6 , 20' dead/dying cottonwoods, 2, 20' dead/dying pine trees that were falling over from the wind over .32 acres; none of which can be seen from offsite) is completely untrue, with unmitigated direct impacts to the sensitive and critical stream zone buffers, including crossing Thomas Creek w/ heavy equipment, clearly having occurred. If able, please share the County's position on the SUP application, especially given that much of the work has already occurred w/ out a permit, misleading information is included in the application (e.g., 8, dead/dying cottonwood/pine trees w/ grading over 0.32 acres) and BMPs are still either incorrectly installed (straw wattle) or not installed at all (silt fence).

Regards,

Ken Greene









DEPARTMENT OF THE ARMY
U.S. ARMY CORPS OF ENGINEERS, SACRAMENTO DISTRICT
1325 J STREET
SACRAMENTO CA 95814-2922

CERTIFIED MAIL RETURN RECEIPT REQUESTED

September 5, 2018

Regulatory Division (SPK-2018-00705)

Mr. Randy and Mrs. Kami Soule
13990 Welcome Way
Reno, Nevada 89511

Dear Mr. and Mrs. Soule:

The U.S. Army Corps of Engineers, Sacramento District (this office) has received a report concerning an activity that may have been conducted in waters of the United States without a Department of the Army permit. This letter is a request for information regarding the potential unauthorized activity located on Thomas Creek, 13990 Welcome Way, Latitude 39.4182°, Longitude -119.7981°, Reno, Washoe County, Nevada (enclosures 1-2).

Section 404 of the Clean Water Act requires a Department of the Army (DA) permit prior to the discharge of dredged or fill material into waters of the United States, including wetlands, except where specifically exempted (enclosure 3). This office has the responsibility for reviewing and issuing DA permits and investigating potential unauthorized activities within this area.

This office has received reports that dredged or fill material, which include boulders, cobble and soil, has been discharged into Thomas Creek. Review of aerial photography and photographs and video submitted to this office indicates that the stream channel has been recently altered along approximately 420 linear feet.

This office has opened an investigation in order to determine whether the activity performed at the subject site is regulated under Section 404 of the Clean Water Act and occurred without a DA permit. We appreciate your cooperation in this investigation. To assist this office, the following information is requested from you:

1. A description of all activities that have occurred in any type of aquatic resource on the site. Aquatic resources include, but are not limited to, rivers, streams, lakes, ponds and wetlands. The information you provide should include the purpose for the work, when the work was conducted (start and end dates), what equipment was used, the area (in acres) of the aquatic resource that was affected, and the amount (in cubic yards) and type of material that was discharged into the aquatic resource.

2. A copy of any Federal, State, or local permits or other authorization obtained for the activity.
3. Names and addresses of the individuals or companies that conducted the activity; and
4. Photographs of the site before and after the activity.

This office is open to receiving any other information you believe would be pertinent to our initial investigation of this matter. The information you provide will become part of the public record. It may be presented in any enforcement action that results from this investigation and will be retained in this office's administrative records. All information you wish to provide should be submitted to this office within 30 days of the date of this letter.

Thank you in advance for your cooperation on this matter. Please refer to identification number SPK-2018-00705 in correspondence concerning this investigation. If you have any questions, or would like to schedule a meeting with this office, please contact Aaron Park at our Reno Regulatory Field Office, 300 Booth Street, Room 3050, Reno, Nevada 89509-1328, by email at Aaron.C.Park@usace.army.mil, or telephone at (775) 784-5305. For more information regarding our program, please visit our website at www.spk.usace.army.mil/Missions/Regulatory.aspx.

Sincerely,

Jason Gipson
Chief, Nevada-Utah Section

Enclosures

cc:

Jean Stone, NDEP, BWQP, jstone@ndep.nv.gov
Donette Barreto, P.E., NDEP, BWPC, dbarreto@ndep.nv.gov
Andrew Dixon, NDEP, BWPC, andrew.dixon@ndep.nv.gov
Kristie Black, NDEP, BWPC, kblack@ndep.nv.gov



**Washoe-Storey
Conservation
District**

**Natural Resource
Conservation Service
1365 Corporate Blvd.
Reno, NV 89502**

**Tel: (775) 857-8500
ext. 131
Fax: (775) 857-8525**

Board of Supervisors:

Bret Tyler
Chairman
Jeanne Herman
Washoe County
Supervisor

Kevin Roukey
Director

Tory Friedmen
Supervisor
Spencer Scott
Supervisor

Kathy Canfield
Storey County
Supervisor

OPEN
City Appointee

**Julee Olander, Planner
Washoe County Community Services Department
Planning and Development Division
1001 E. Ninth St., Bldg. A
Reno, NV 89512**

September 11, 2018

Subject: August Agency Review – Case Nos. – WSUP18-0017 (Soule Grading)

Julie,

Thank you for providing us the August Agency Reviews and the opportunity to review and provide comments. We have reviewed the subject proposed project as requested and we have the following comments:

Special Use Permit Number WSUP18-0017 (Soule Grading)

The proposed project is to approve a special use permit to approve a special use permit for grading, which was performed without the required permit(s) within a significant hydrological resource (SHR), by grading and removing vegetation within the Thomas Creek Critical Stream Zone. The project is located in NE ¼ of Section 24, T18N, R19E, MDBM in Washoe County. We have the following comments on this proposed project:

1. Regarding SUP Supplemental Information:
 - a. Item 1 – What is the Purpose of the Grading? - The applicant states that the project is to clean up the site from several harsh winters and the 2017 Flooding, which required removal of trash, debris, dead and dying vegetation. In reviewing the attached photos it appears that the work was done with heavy equipment and removal all vegetation in many areas. It also appears that the morphology of the stream bed was altered, filled and excavated to create a small pond. This type of activity may require a Department of the Army Permit from the U.S. Army Corps of Engineers under Section 404 of the Clean Waters Act. It is our recommendation that the applicant contact the Corps of Engineers to determine if an Aquatic Resources Delineation needs to be conducted and identify how many acres of waters of the United States or wetlands may have been impacted. The project description should be revised to state that the project will include impacting x.xx acres of waters of the United States or wetlands by the placement of fill material into the existing stream bed below the ordinary high water mark (Thomas Creek) or into adjacent wetlands.
 - b. Item 4 – How many cubic yards of material are you exporting or importing? If none, how are you managing to balance the work on-site? – The applicant states none and that the existing land contours will remain the same. Again from the attached photos it appears that material has be excavated from some areas and redeposited in other wot create the pond area to create the upstream inlet and the downstream outlet. Due to the presence of waters of the United States on the project site (Thomas Creek – tributary to Steam Boat Creek). **Therefore, it is our recommendation that the applicant provide us with detailed drawings showing the BMPs that will be put in place during the restoration and the proposed seed mix and tree species that are proposed to be planted for our review.**
 - c. Item 5 – Is it possible to develop your property without surpassing the grading thresholds requiring a Special Use Permit? (Explain your

answer fully) – The applicant states, yes, then goes on to state that the grading threshold were not exceeded. But due to the nature of the work along the stream zone, the County demanded a Special Use Permit, which was opposed by the owner, who has agreed to submit. Although the applicant states that the proposed improvements constitute general cleanup and aesthetic enhancement, when in fact it is a major construction project that has changed the morphology of the existing streambed of Thomas Creek within the limits of his parcels.

Because there was no permit application for the project to be reviewed with the appropriate pre-project survey and maps, there were no grading thresholds established. The 2009 survey of the parcel does not provide any contours, and the contour maps on the Washoe County Assessor's Mapping is minimal.

The Washoe County Development Code 110.418 – Significant Hydrologic Resources Section 110.418.00 – PURPOSE states ... “Negative activities in the buffer areas may impact the quality or quantity of the existing hydrology, soil characteristics, vegetation communities or topography thereby jeopardizing the resource's functions.

The intent of these regulations is to protect the public health, safety and welfare by:

(a) Preserving, protecting and restoring the natural functions of existing perennial streams in Washoe County;

(b) Reducing the need for the expenditure of public funds to remedy or avoid flood hazards, erosion, or other situations caused by inappropriate alterations of streams;

(c) Ensuring the natural flood control functions of perennial streams including, but not limited to, storm water retention and slow-release detention capabilities are maintained;

(d) Ensuring storm water runoff and erosion control techniques are utilized to stabilize existing stream banks, reduce downstream sediment loading, and ensure the safety of people and property;

(e) Ensuring the natural water quality functions of perennial streams including, but not limited to, pollution filtering, groundwater recharge, nutrient storage, nutrient recycling capabilities, and sediment filtering capabilities are not impacted by existing and proposed developments;

(f) Encouraging common open space developments to avail hazardous or environmentally sensitive areas, protect important habitat and open space areas, and minimize impacts on groundwater recharge areas;

(g) Establishing buffer areas around all significant hydrological resource areas to ensure the resource is not jeopardized or degraded by adjacent offsite development activity;

(h) Ensuring a no net loss of value, acreage and function of each different significant hydrological resources is adhered to; and

(i) Identifying, establishing and managing perennial streams as mitigation sites for destroyed or degraded hydrological resources.”

Section 110.418.15 - Perennial Streams Buffer Areas. Perennial stream buffer areas are established to provide adequate setbacks and land use controls to ensure water quality functions of each perennial stream are not jeopardized through development activity. To limit significant impacts adjacent to hydrological resources, two (2) buffer areas are hereby established—the "critical stream zone buffer area" and the "sensitive stream zone buffer area". All proposals to develop uses within the critical stream zone buffer area and/or the sensitive stream zone buffer area shall submit a site plan with precise dimensions depicting the boundary line for the buffer areas.

(a) Critical Stream Zone Buffer Area. The critical stream zone buffer area shall be all land and water surface within thirty (30) feet from the centerline of the perennial stream. The centerline of the stream shall be determined by either survey from a licensed

surveyor or by determination of the thalweg (i.e. the line connecting points of maximum water depth) from a topographic survey, or appropriate USGS 7.5 minute topographic map covering the site.

(b) Sensitive Stream Zone Buffer Area. The sensitive stream zone buffer area shall be all land and water surface between the critical stream zone buffer area boundary of thirty (30) and one hundred fifty (150) feet from centerline or thalweg of the perennial stream.

The Applicant was aware of these restrictions because they are clearly delineated on the survey of the parcel map that was completed and signed by them on June 25, 2009. Therefore, when reviewing the application for the Special Use Permit we request that the County Planning Development Department ensure that all aspects of SECTION 110.418.30 be adhered to.

Special Review Considerations which states ... "In addition to the findings required by Article 810, Special Use Permits, prior to approving an application for development in the critical stream zone buffer area or the sensitive stream zone buffer area, the record at the Planning Commission shall demonstrate that the following special review considerations are addressed:

- (a) Conservation of topsoil;
- (b) Protection of surface water quality;
- (c) Conservation of natural vegetation, wildlife habitats and fisheries;
- (d) Control of erosion;
- (e) Control of drainage and sedimentation;
- (f) Provision for restoration of the project site to predevelopment conditions;
- (g) Provision of a bonding program to secure performance of requirements imposed; and
- (h) Preservation of the hydrologic resources, character of the area and other conditions as necessary."

The applicant also needs to ensure that the natural resource protection and conservation will be conducted in coordination with the following agencies:

- Washoe-Storey Conservation District (WSCD) to review the restoration planting plan and installation of BMPs,
- U.S Army Corps of Engineers (USACE), to determine if and aquatic resources delineation and after-the -fact permit under Section 404 of the Clean Water Act is needed,
- Nevada Division of Environmental Protection (NDEP) for a Working in Waters Permit and Section 401 Water Quality Certification are needed and the
- Nevada Division of Wildlife (NDOW) to ensure there are no further impacts to aquatic or other wildlife.

The project did involve the reconfiguration of including, including, what appears to be, the placement of fill in a portion of the potential wetlands and stream bed. **Therefore it is our recommendation that the applicant provide us with all required applications and documentation for the applications for our review.**

Our initial review of the project area found that the USFWS NWI Surface Waters and Wetlands mapping indicate the project site to include the following types of wetland types on site:

PFOA – 1.33 acres - Freshwater Forested/Shrub Wetland - Palustrine, Scrub Shrub, seasonally flooded. This is the type of aquatic resource that the project area impacted when constructed.

- d. Item 7 – Have you shown all areas on your site plan that are proposed to be disturbed by grading? – The applicant states, yes. The applicant’s site plan is lacking in that is simply a rough rendering and is not a surveyed depiction of the current condition after the work was performed. They did not provide a cross-sections of the proposed project area that indicates the existing ground level and the existing stream bottom elevations including those upstream and downstream of the property lines to ensure that the stream morphology will not be altered from storm events. Are there any historic records that provide support that the existing bottom contours of Thomas Creek in this area to support the applicant’s statements that he did not change the bottom contours of the creek?

If not then the apparent widening area (pond) would become a sediment storage capacity increase, not restoration, and again could change the flow regime downstream. All of these factors need to be assessed. Therefore it is our recommendation that the permit be conditioned to require the applicant to provide, the agencies listed above, with adequate engineering drawings, including cross sections adequately spaced across the Sensitive Stream Zone Buffer Limit on both sides of the centerline of the creek. Also a detailed surveyed site map, with dimensions and labeled contour lines should accompany the drawings. **Therefore it is our recommendation that the permit be conditioned to require the applicant to provide this information to the agencies listed above for their review prior to approving the SUP.**

Item 10 – What is the slope (Horizontal/Vertical) of the cut and fill areas proposed to be? What Methods will be used to prevent erosion until the revegetation is established? – The applicant states that no cut or fill is planned. The attached photos clearly show that cut and fill, however minimal, did indeed occur. The applicant’s response with regards to prevent erosion is that erosion waddles have been placed parallel to the stream to prevent erosion and the area disturbed will be spray re-planted with meadow grass seed that will include and organic stabilizer. In reviewing the attached photos I could see no evidence of properly bundled and placed waddles along the creek bank to prevent erosion. . The plans submitted with the application do not have an adequate revegetation plan. It shows no proposed BMPs locations, no tree plantings to replace the riparian vegetation removed. **Therefore it is our recommendation that the application be condition to require the submittal of the revegetation plan and the SWPPP for our review prior to approval of the SUP.**

Item 14 – Will the grading proposal require removal of any trees? If so, what species, how many and what size? The applicant states yes and approximately six dead or dying Cottonwood trees that were 10’ to 20’ tall; approximately 2 dead or dying pine trees that are over 20’ tall and were falling over from the winds. The applicant gives no dimensions of the girth of any of the trees.

It is difficult to assess from the attached photos from the debris piles what trees and other riparian vegetation were removed during the excavation. **Therefore it is our recommendation that the applicant assess the creek, the same distance as the length of their project area, upstream and downstream, and determine tree density and measure the girth of the trees at the proper height and provide that information to the County and the listed agencies for their review. So that an appropriate number and size of trees can be determined to be replanted to replace the total of the girth and canopy lost.**

Item 15 – What type of revegetation seed mix are you planning to use and how many pounds per acre do you intend to broadcast? Will you use mulch and if so, what type? The applicant left this box blank, but noted it with an asterisk. I could find no asterisked comment anywhere in the application.

Therefore it is our recommendation that the permit be conditioned to require the applicant to submit the revegetation seed mix they are planning to use and the pounds per acre they intend to broadcast and whether or not they intend to use mulch to the WSCD for review and approval prior to the final approval of the SUP.

Item 16 – How are you providing temporary irrigation to the disturbed area? The applicant stated that they are assuming that the natural ground moisture from the creek zone should be adequate for growth. If not the owner owns 5 acre feet of creek water that is of beneficial use to this property. If this is the applicant's proposed plan then an adequate hydrologic study should be conducted of ground water depths to ensure the trees are planted deep enough to access the water table and that the seed mix is adequately watered until their roots access the water table. **Therefore it is our recommendation that the permit be conditioned to require the applicant to submit either a hydrologic ground water study indicating the ground water is accessible to the vegetation for the next 5 years or until it reaches the determined success criteria, or a temporary irrigation plan and the monitoring plan he will be following to ensure the restoration is successful to the appropriate agencies prior to final approval of the SUP.**

Item 17 – Have you reviewed the revegetation plan with the Washoe-Storey Conservation District? If yes, have you incorporated their suggestions? – The applicant states no. (See item 15 comments)

Sincerely,

// Original Signed by Kevin J. Roukey

Kevin J. Roukey, District Director
Washoe/Storey Conservation District

From: Gifford, Jim - NRCS, Minden, NV
To: [Olander, Julee](#)
Cc: lynmundt@mac.com
Subject: FW: Thomas Creek
Date: Friday, September 14, 2018 8:15:07 AM
Attachments: [Streambank Bioengineering Guide.pdf](#)
[580 Streambank and Shoreline Protection.pdf](#)

Hi Julee,

Lyn Mundt gave me a call to see if the Natural Resources Conservation Service (NRCS) could help out in any way regarding the grading that was done on Thomas Creek. Unfortunately we can't provide any on the ground assistance with you because our focus is working with farmers and ranchers on agricultural land. We're just too short staffed and too far behind to get involved, plus we are not a regulatory agency.

But I did want to pass on our standards for Streambank and Shoreline Protection and the Practical Streambank Bioengineering Guide. The Streambank Bioengineering guide is an oldy, but a goody. I hope you find these helpful. Please let me know if you have any questions.

Thank you,

Jim Gifford
District Conservationist
NRCS Minden Field Office
1702 County Road, Suite A1
Minden, NV 89423
(775)782-3661 ext. 3829

From: Lyn Mundt <lynmundt@mac.com>
Sent: Tuesday, September 11, 2018 2:19 PM
To: Gifford, Jim - NRCS, Minden, NV <Jim.Gifford@nv.usda.gov>
Subject: Thomas Creek

Thanks Jim!

Here is the Special Use Permit information. I will send pictures in a follow up email.

SUP18-0017 (Soule Grading)

APN: [049-165-06](#) & 07

WC Staff:

Julee Olander, [775-328-3627](tel:775-328-3627); jolander@washoecounty.us

Trevor Lloyd, [775-328-3617](tel:775-328-3617)

Grading was performed on and in a significant portion of Thomas Creek at this site without the required permit(s). This graded area is within a significant hydrological resource (SHR), and involved the removal of all vegetation within the Thomas Creek Critical Stream Zone. Therefore applicant's action is in violation of Washoe County Code.

Sent from my iPhone

This electronic message contains information generated by the USDA solely for the intended recipients. Any unauthorized interception of this message or the use or disclosure of the information it contains may violate the law and subject the violator to civil or criminal penalties. If you believe you have received this message in error, please notify the sender and delete the email immediately.

**NATURAL RESOURCES CONSERVATION SERVICE
CONSERVATION PRACTICE STANDARD**

STREAMBANK AND SHORELINE PROTECTION

(Ft.)

CODE 580

DEFINITION

Treatment(s) used to stabilize and protect banks of streams or constructed channels, and shorelines of lakes, reservoirs, or estuaries.

PURPOSE

- To prevent the loss of land or damage to land uses, or facilities adjacent to the banks of streams or constructed channels, shoreline of lakes, reservoirs, or estuaries including the protection of known historical, archeological, and traditional cultural properties.
- To maintain the flow capacity of streams or channels.
- Reduce the offsite or downstream effects of sediment resulting from bank erosion.
- To improve or enhance the stream corridor for fish and wildlife habitat, aesthetics, recreation.

CONDITIONS WHERE PRACTICE APPLIES

This practice applies to streambanks of natural or constructed channels and shorelines of lakes, reservoirs, or estuaries where they are susceptible to erosion. It does not apply to erosion problems on main ocean fronts, beaches or similar areas of complexity.

CRITERIA

General Criteria Applicable to All Purposes

Treatments shall be in accordance with all applicable local, state and federal laws and regulations.

Treatments applied shall seek to avoid adverse effects to endangered, threatened, and candidate species and their habitats, whenever possible.

Treatments applied shall seek to avoid adverse effects to archaeological, historic, structural, and traditional cultural properties, whenever possible.

An assessment of unstable streambank or shoreline sites shall be conducted in sufficient detail to identify the causes contributing to the instability (e.g. livestock access, watershed alterations resulting in significant modifications of discharge or sediment production, in channel modifications such as gravel mining, head cutting, water level fluctuations, boat-generated waves, etc.).

Proposed protective treatments to be applied shall be compatible with improvements being planned or installed by others.

Protective treatments shall be compatible with the bank or shoreline materials, water chemistry, channel or lake hydraulics, and slope characteristics above and below the water line.

End sections of treatment areas shall be adequately anchored to existing treatments, terminate in stable areas, or be otherwise stabilized to prevent flanking of the treatment.

Protective treatments shall be installed that result in stable slopes. Design limitations of the bank or shoreline materials and type of measure installed shall determine steepest permissible slopes.

Designs will provide for protection of installed treatments from overbank flows resulting from upslope runoff and flood return flows.

Internal drainage for bank seepage shall be provided when needed. Geotextiles or properly

Conservation practice standards are reviewed periodically, and updated if needed. To obtain the current version of this standard, contact the Natural Resources Conservation Service [State Office](#), or visit the [Field Office Technical Guide](#).

NRCS, Nevada

September 2010

**WSUP18-0017
EXHIBIT F**

designed filter bedding shall be incorporated with structural measures where there is the potential for migration of material from behind the measure.

Treatments shall be designed to account for any anticipated ice action, wave action, and fluctuating water levels.

All disturbed areas around protective treatments shall be protected from erosion. Disturbed areas that are not to be cultivated shall be protected as soon as practical after construction.

Vegetation shall be selected that is best suited for the site conditions and achieves the intended purpose(s).

In order to ensure plant community establishment and integrity, a vegetative management plan shall be prepared in accordance with NRCS conservation practice standard Critical Area Planting, Code 342.

Additional Criteria for Streambanks

Stream segments to be protected shall be classified according to a system deemed appropriate by the state. Segments that are incised or that contain the 5-year return period (20 percent probability) or greater flows shall be evaluated for further degradation or aggradation.

A site assessment shall be performed to determine if the causes of instability are local (e.g. poor soils, high water table in banks, alignment, obstructions deflecting flows into bank, etc.) or systemic in nature (e.g. aggradation due to increased sediment from the watershed, increased runoff due to urban development in the watershed, degradation due to channel modifications, etc.). The assessment need only be of the extent and detail necessary to provide a basis for design of the bank treatments and reasonable confidence that the treatments will perform adequately for the design life of the measure.

Changes in channel alignment shall not be made without an assessment of both upstream and downstream fluvial geomorphology that evaluates the affects of the proposed alignment. The current and future discharge-sediment regime shall be based on an assessment of the watershed above the proposed channel alignment.

NRCS, Nevada

September 2010

Bank protection treatment shall not be installed in channel systems undergoing rapid and extensive changes in bottom grade and/or alignment unless the treatments are designed to control or accommodate the changes. Bank treatment shall be constructed to a depth at or below the anticipated lowest depth of streambed scour.

If the failure mechanism is a result of the degradation or removal of riparian vegetation, stream corridor restoration shall be implemented, where feasible, (see Additional Criteria for Stream Corridor Improvement) as well as treating the banks.

Toe erosion shall be stabilized by treatments that redirect the stream flow away from the toe or by structural treatments that armor the toe. Additional design guidance is found in the EFH Part 650, Chapter 16, Streambank and Shoreline Protection.

Where toe protection alone is inadequate to stabilize the bank, the upper bank shall be shaped to a stable slope and vegetated, or shall be stabilized with structural or soil-bioengineering treatments.

Channel clearing to remove stumps, fallen trees, debris, and sediment bars shall only be performed when they are causing or could cause unacceptable bank erosion, flow restriction, or damage to structures. Habitat forming elements that provide cover, food, pools, and water turbulence shall be retained or replaced to the extent possible.

Treatments shall be functional and stable for the design flow and sustainable for higher flow conditions.

Treatments shall not induce an increase in natural erosion.

Treatments shall not limit stream flow access to the floodplain.

Where flooding is a concern, the effects of protective treatments shall not increase flow levels above those that existed prior to installation.

Additional Criteria for Shorelines

All revetments, bulkheads or groins are to be no higher than 3 feet (1 meter) above mean high tide, or mean high water in non-tidal areas

Structural shoreline protective treatments shall be keyed to a depth to prevent scour during low water.

For the design of structural treatments, the site characteristics below the waterline shall be evaluated for a minimum of 50 feet (15 meters) horizontal distance from the shoreline measured at the design water surface.

The height of the protection shall be based on the design water surface plus the computed wave height and freeboard. The design water surface in tidal areas shall be mean high tide.

When vegetation is selected as the protective treatment, a temporary breakwater shall be used during establishment when wave run up would damage the vegetation.

Additional Criteria for Stream Corridor Improvement

Stream corridor vegetative components shall be established as necessary for ecosystem functioning and stability. The appropriate composition of vegetative components is a key element in preventing excess long-term channel migration in re-established stream corridors. The establishment of vegetation on channel banks and associated areas shall also be in accordance with conservation practice standard Critical Area Planting, Code 342.

Treatments shall be designed to achieve habitat and population objectives for fish and wildlife species or communities of concern as determined by a site-specific assessment or management plan. Objectives shall be based on the survival and reproductive needs of populations and communities, which include habitat diversity, habitat linkages, daily and seasonal habitat ranges, limiting factors and native plant communities. The type, amount, and distribution of vegetation shall be based on the requirements of the fish and wildlife species or communities of concern to the extent possible.

Treatments shall be designed to meet aesthetic objectives as determined by a site-specific assessment or management plan. Aesthetic objectives shall be based on human needs, including visual quality, noise control, and microclimate control. Construction materials, grading practices, and other site development

elements shall be selected and designed to be compatible with adjacent land uses.

Treatments shall be designed to achieve recreation objectives as determined by a site-specific assessment or management plan. Safety requirements shall be based on type of human use and recreation objectives.

CONSIDERATIONS

When designing protective treatments, consideration should be given to the changes that may occur in the watershed hydrology and sedimentation over the design life of the treatments.

Consider utilizing debris removed from the channel or streambank into the treatment design when it is compatible with the intended purpose to improve benefits for fish, wildlife and aquatic systems.

Use construction materials, grading practices, vegetation, and other site development elements that minimize visual impacts and maintain or complement existing landscape uses such as pedestrian paths, climate controls, buffers, etc. Avoid excessive disturbance and compaction of the site during installation.

Utilize vegetative species that are native and/or compatible with local ecosystems. Avoid introduced, invasive, noxious or exotic species that could become nuisances. Consider species that have multiple values such as those suited for biomass, nuts, fruit, browse, nesting, aesthetics and tolerance to locally used herbicides. Avoid species that may be alternate hosts to disease or undesirable pests. Species diversity should be considered to avoid loss of function due to species-specific pests. Species on noxious plant lists should not be used.

Select plant materials that provide habitat requirements for desirable wildlife and pollinators. The addition of native forbs and legumes to grass mixes will increase the value of plantings for both wildlife and pollinators.

Treatments that promote beneficial sediment deposition and the filtering of sediment, sediment-attached, and dissolved substances should be considered.

Consider maintaining or improving the habitat value for fish and wildlife by including treatments that provide aquatic habitat in the treatment

NRCS, Nevada

September 2010

**WSUP18-0017
EXHIBIT F**

design and that may lower or moderate water temperature and improve water quality.

Consider the need to stabilize side channel inlets and outlets and outlets of tributary streams from erosion.

Consider aquatic habitat when selecting the type of toe stabilization.

Consider maximizing adjacent wetland functions and values with the project design and minimize adverse effects to existing wetland functions and values.

Livestock exclusion shall be considered during establishment of vegetative treatments and appropriate grazing practices applied after establishment to maintain plant community integrity. Wildlife may also need to be controlled during establishment of vegetative treatments. Temporary and local population control methods should be used with caution and within state and local regulations.

When appropriate, establish a buffer strip and/or diversion at the top of the bank or shoreline protection zone to help maintain and protect installed treatments, improve their function, filter out sediments, nutrients, and pollutants from runoff, and provide additional wildlife habitat.

Consider conservation and stabilization of archeological, historic, structural and traditional cultural properties when applicable.

Consider safety hazards to boaters, swimmers, or people using the shoreline or streambank when designing treatments.

Protective treatments should be self-sustaining or require minimum maintenance.

PLANS AND SPECIFICATIONS

Plans and specifications for streambank and shoreline protection shall be prepared for specific field sites and based on this standard and shall describe the requirements for applying the practice to achieve its intended purpose. Plans shall include treatments to minimize erosion and sediment production during construction and provisions necessary to comply with conditions of any environmental agreements, biological opinions or other terms of applicable permits.

OPERATION AND MAINTENANCE

An operation and maintenance plan shall be prepared for use by the owner or others responsible for operating and maintaining the system. The plan shall provide specific instructions for operating and maintaining the system to insure that it functions properly. It shall also provide for periodic inspections and prompt repair or replacement of damaged components or erosion.

REFERENCES

NEH Part 650, Chapter 16, Streambank and Shoreline Protection.



The Practical Streambank Bioengineering Guide

**User's Guide
for
Natural Streambank Stabilization Techniques
in the Arid and Semi-Arid
Great Basin and Intermountain West**

**USDA Natural Resources Conservation Service
Plant Materials Center
Aberdeen, Idaho**

**WSUP18-0017
EXHIBIT F**

The Practical Streambank Bioengineering Guide

User's Guide for Natural Streambank Stabilization Techniques in the Arid and Semi-arid Great Basin and Intermountain West

prepared by:

Gary Bentrup, Landscape Architect
215 Blvd. #1
Logan , UT 84321
(435) 750-5621

J. Chris Hoag, Wetland Plant Ecologist
Interagency Riparian/Wetland Plant Development Project
USDA-Natural Resources Conservation Service
Plant Materials Center
P.O. Box 296
Aberdeen, ID 83210
(208) 397-4133

**Information from this guide may be copied and distributed with a full citation to the Interagency Riparian/
Wetland Project and the authors.**

May 1998

The United States Department of Agriculture (USDA) prohibits discrimination in all its programs and activities on the basis of race, color, national origin, gender, religion, age, disability, political beliefs, sexual orientation, and marital or familial statuses. (Not all prohibited bases apply to all programs.) Persons with disabilities who require alternative means for communication of program information (Braille, large print, audiotape, etc.) should contact the USDA's TARGET CENTER at (202) 720-2600 (voice & TDD).

To file a complaint of discrimination, write USDA, Director, Office of Civil Rights, Room 326w, Whitten Building, 14th and Independence Avenue, SW, Washington, D.C. 20250-9410, or call (202) 720-5964, (voice or TDD).

USDA is an equal employment opportunity provider and employer.



Acknowledgments

This guide would not have been possible without the expert advice and comments provided by the following reviewers:

- * **Hollis Allen**, Ecologist, USACE Waterways Experiment Station, Vicksburg, MS
- * **Forrest Berg**, Stream Mechanics Engineer, USDA Natural Resources Conservation Service, Bozeman, MT
- * **David Blew**, Water Quality Resource Conservationist, Soil Conservation Commission, Boise, ID
- * **Jim Cornwell**, State Range Management Specialist, USDA Natural Resources Conservation Service, Boise, ID
- * **Terry Costner**, Hydraulic Engineer, USDA Natural Resources Conservation Service, Bozeman, MT
- * **Phil Delphy**, Fish and Wildlife Biologist, U.S. Fish and Wildlife Service, Boise, ID
- * **John Englert**, Horticulturist/Team Leader, National Plant Materials Center, Beltsville, MD
- * **Frank Fink**, State Biologist, USDA Natural Resources Conservation Service, Boise, ID
- * **Grant Grunee**, Senior Project Manager, Aquatic and Wetland Companies, Boulder, CO
- * **Emerenciana Hurd**, Botanist, USDA Forestry Sciences Lab, Boise, ID
- * **Craig Johnson**, Landscape Architect, Department of Landscape Architecture and Environmental Planning, Utah State University, Logan, UT
- * **Jennifer Kujawski**, Resource Conservationist, National Plant Materials Center, Beltsville, MD
- * **Sharon Norris**, Conservation Communication Specialist, USDA Natural Resources Conservation Service, Boise, ID
- * **Dan Ogle**, Plant Materials Specialist, USDA Natural Resources Conservation Service, Boise, ID
- * **Mark Petersen**, Resource Conservationist, Water Resources Staff, USDA Natural Resources Conservation Service, Salt Lake City, UT
- * **Mike Rotar**, Professional Engineer, Inter-Fluve, Bozeman, MT
- * **Nancy Shaw**, Botanist, USDA Forestry Sciences Lab, Boise, ID
- * **Art Shoemaker**, State Conservation Engineer, USDA Natural Resources Conservation Service, Boise, ID
- * **Lynda Smithman**, Botanist, USDA Forestry Sciences Lab, Boise, ID
- * **Terrill Stevenson**, State Geologist, USDA Natural Resources Conservation Service, Boise, ID
- * **Sandy Wyman**, Range Management Specialist, USDA Natural Resources Conservation Service, Bozeman, MT

The authors gratefully acknowledge the following for their sponsorship and funding: **USDA Natural Resources Conservation Service, USDI Bureau of Land Management, USDI Bureau of Reclamation, USDI Fish and Wildlife Service, USDA Forest Service, Idaho Department of Fish and Game, Idaho Transportation Department, Idaho Power Company, and Carolyn Adams, Director, Watershed Science Institute, USDA Natural Resources Conservation Service headquartered at the University of Washington, Seattle, WA.**



Preface

In the arid and semi-arid Great Basin and Intermountain West, streams and riparian areas are rare and precious resources, often visible in the landscape for miles as ribbons of green. These habitats provide a disproportionately large number of benefits for such a small percentage of the landscape.

The condition of streams and riparian areas reflect the health of the surrounding landscape. Where rivers and riparian areas are healthy, full of life and energy, the stewards of that place must respect the land. Where rivers and riparian areas are degraded, it is most likely that the area's residents do not understand the interconnectedness of these resources.

This publication was written to provide guidance for those interested in streambank bioengineering. It was also written to increase awareness of streams and riparian areas, their importance, and their interconnectedness with other resources. In essence, they reflect our values, our sense of place, and our concern for fellow citizens. Streams and riparian areas record these values and beliefs to be read by future generations. Let's make sure the record is one of stewardship.

Gary Bentrup
J. Chris Hoag

*"The care of rivers is not a question of rivers,
but of human heart"*

Tanka Shozo

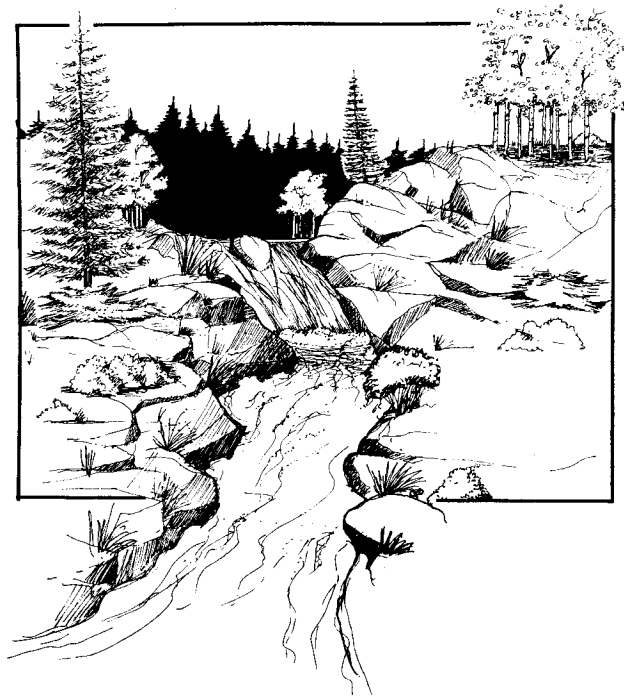


Table of Contents

Chapter One - Introduction

Purpose and Scope.....	2
What is a Riparian Area?.....	2
Why are Riparian Areas Valuable?.....	3
Status of Riparian Areas and Streams.....	5

Chapter Two - Understanding Your Stream and Watershed

Watershed Approach.....	7
Proper Land Management.....	8
Agriculture.....	9
Livestock Grazing.....	11
Forestry.....	13
Urbanization.....	14
Restoration Tool: Beaver.....	16

Chapter Three - Streambank Bioengineering

Advantages and Disadvantage.....	18
Basic Planning and Design Principle.....	19
Preliminary Inventory.....	20
Detailed Inventory and Analysis.....	24
Design Process.....	29
Permit Process.....	34
Implementation.....	35

Chapter Four - Vegetation Selection and Procurement

Species Selection.....	37
Plant Material Procurement and Handling.....	37
Planting Location.....	41
Establishment Techniques.....	41
Management.....	42

Chapter Five - Maintenance and Monitoring

Maintenance.....	50
Monitoring.....	50

Glossary.....	56
---------------	----

Resources.....	57
----------------	----

References.....	63
-----------------	----



List of Figures and Tables

Figure

1.1	Riparian Area.....	2
1.2	Riparian Functions.....	3
3.1	Multiple Scales of Inventory and Assessment.....	20
3.2	Base Map with Field Notes.....	24
3.3	Streambank Zones and Bankfull Discharge.....	25
3.4	Groundwater Monitoring Wells.....	26
3.5	Stratified Streambanks and Combination Failures.....	27
3.6	Bank Erosion Due to Piping.....	28
3.7	Willow Brush Mattress Technique.....	29
3.8	Endpoint Protection.....	31
3.9	Bioengineering Techniques.....	33
3.10	Theoretical Example of Combining Techniques.....	35
4.1	Collecting Cuttings.....	38
4.2	Planting Zones.....	41
5.1	Use of Metal Pins to Monitor Bank Erosion.....	51
5.2	Acquiring Cross-sectional Data.....	52
5.3	Example of Vegetation Monitoring.....	53
5.4	Crest Staff Gauge.....	54
5.5	Bioengineering Monitoring Sheet.....	55

Table

3.1	Geomorphic Valley Forms.....	22
3.2	Maximum Tractive Forces for Bioengineering.....	31
4.1	Woody Species for Bioengineering in the Great Basin and Intermountain West.....	43 47
4.2	Herbaceous Species for Bioengineering in the Great Basin and Intermountain West.....	54
5.1	Potential Evaluation Methods.....	



Appendices

Appendix A - Bioengineering Technique Sheets

Brush Revetment	Brush Layer
Pole Plantings	Brush Trench
Post Plantings	Vertical Bundles
Brush Mattress	Willow Wattles
Fiberschines	Erosion Control Fabric

Appendix B - Plant Species for Bioengineering

Plant Datasheets and Illustrations

Appendix C - Sample Monitoring Sheet

Comment Sheet





Nebraska Sedge
Carex nebrascensis

Chapter One
Introduction



Introduction

PURPOSE AND SCOPE

The *Practical Stream Bioengineering Guide* is a user's guide to natural stream stabilization techniques for the arid and semi-arid Great Basin and Intermountain West. Bioengineering can simply be defined as increasing the strength and structure of the soil with a combination of biological and mechanical elements.

This guide was produced primarily for the professional conservationist who provides technical resource assistance to individual landowners. The user should understand that riparian areas are complex ecosystems and that restoration efforts require interdisciplinary teams. The goal of this publication is to provide an easy to understand guide for coordinators of riparian restoration projects. A coordinator needs to have a basic awareness of the overall process and the disciplinary skills required for restoration. Other resources address specific issues in greater detail and should be consulted such as *The Stream Corridor Restoration Handbook* (a multi-agency publication to be published in 1998 - See Resource section).

The first part of this guide covers the basic principles of restoration and bioengineering. The second part consists of detailed, illustrated technique sheets for different bioengineering methods, including how to install, materials, type of use, and other special considerations (Appendix A). This guide was formatted to fit in a three-ring binder so that additional Technique Sheets can be added later. Appendix B includes data sheets and illustrations on plant species suitable for bioengineering techniques. Comments from users of this guide are extremely valuable and will be incorporated in future revisions and Technique Sheets. We have enclosed a comment sheet at the end of

this guide for your use.

The condition of streams and riparian areas reflect the health of the surrounding landscape. Consequently, restoration of these areas needs to address land use management. Bioengineering should not be viewed as a substitute when management changes may be necessary. This guide briefly discusses general management issues for common land uses in the region. The Resource section of this guide as well as other professionals should be consulted for additional information on specific land use management.

WHAT IS A RIPARIAN AREA?

A riparian area is an ecosystem situated between aquatic and upland environments that is at least periodically influenced by flooding. (Fig. 1.1) (Mitsch and Gosselink 1993). Riparian zones often have a rich diversity of plant species and several vegetative layers.

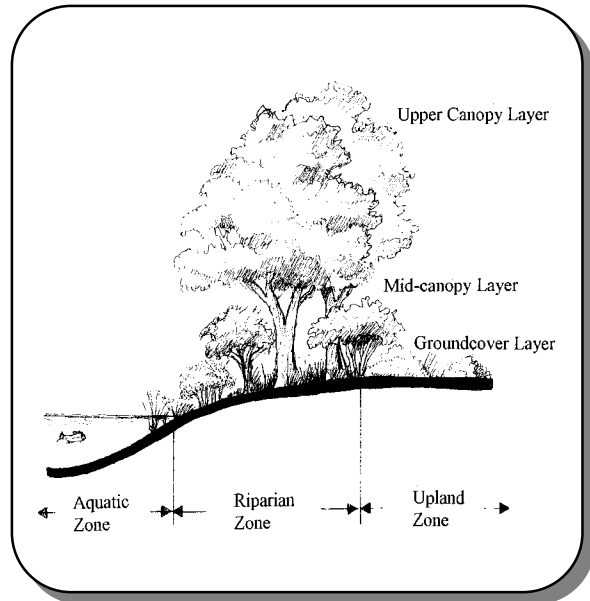


Fig. 1.1 Riparian Area



Riparian vegetation composition and structure is regulated by: (1) frequency, magnitude, duration, and seasonal timing of stream flooding and (2) subsurface moisture conditions. These factors are the result of fluvial processes necessary for the formation and maintenance of riparian ecosystems (Brinson et al. 1981). In the West, riparian areas often appear as green ribbons winding through the gray-brown landscape of grasses and sagebrush.

WHY ARE RIPARIAN AREAS VALUABLE?

Riparian areas provide many important benefits which are well documented (Fig. 1.2) (Hellmund and Smith 1993; Mitsch and Gosselink 1993). The following are just a few of the many benefits that riparian areas provide:

Water Quality Protection

Nonpoint source water pollution occurs as a result of runoff and shallow groundwater flow from urban and rural areas. Nonpoint source pollution is estimated to be responsible for 99% of sediments, 88% of nitrates, 84% of phosphates, and 73% of the biological oxygen demand in our lakes and streams (Clark et al. 1985). Riparian areas can reduce the impacts of nonpoint source pollution in a variety of ways.

Riparian vegetation traps sediments and nutrients from surface runoff and prevents them from entering the aquatic system (Binford and Buchenau 1993). In addition, the dense matrix of roots in a riparian zone can serve as an effective filter of shallow groundwater (Shultz 1994). Nitrogen dissolved in groundwater is a major input to streams in some areas (Peterjohn and Correll 1984). In one study, woody riparian vegetation removed six times as much nitrogen from groundwater as was exported to

The goal of this publication is to provide an easy to understand guide for coordinators of riparian restoration projects. A coordinator needs to have a basic awareness of the overall process and the disciplinary skills required for restoration.

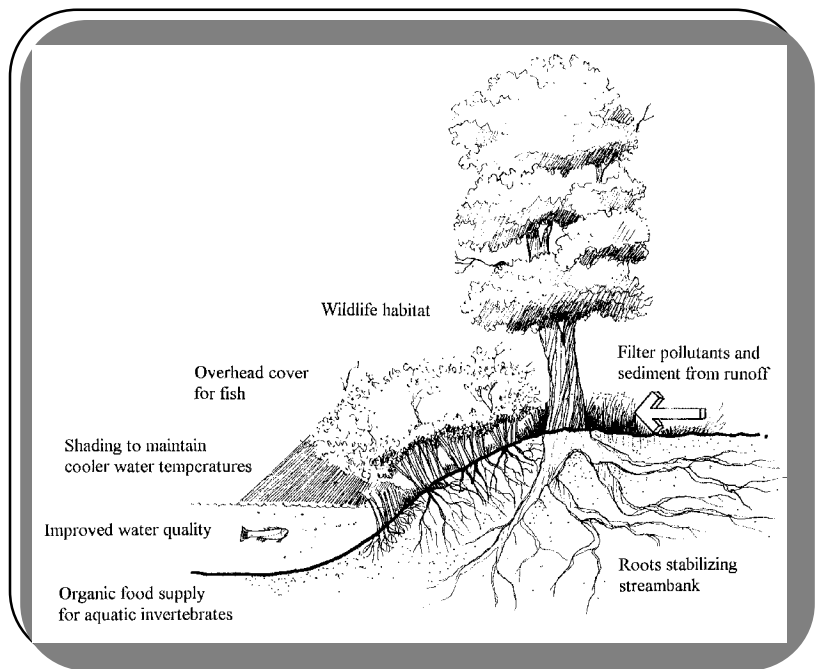


Fig. 1.2 Riparian Functions



the stream (Lowrance et al. 1985). This matrix of roots also reduces sediment delivery to the stream by minimizing streambank erosion (Binford and Buchenau 1993).

Flood Control

Riparian areas also act as a sponge by absorbing floodwaters. The water is then slowly released over a period of time which minimizes flood damage and sustains higher base flows during late summer (Binford and Buchenau 1993). When the flood storage capacity is compromised by human activity, the impacts from flooding can be aggravated. Examples include the mid-western floods of 1993, 1994, and 1997 and the floods in the Pacific Northwest in 1996 and 1997.

Streamflow Maintenance

In our semi-arid to arid environment, some riparian landowners are concerned that riparian vegetation reduces the stream water available for other uses. However, studies have shown that elimination of woody riparian vegetation and debris may result in the eventual loss of summer stream flow because the water storage capacity of the soils is greatly reduced (Stabler 1985). Studies in Utah have shown that mature woody riparian vegetation uses water from below the active stream-flow zone (Dawson and Ehleringer 1991).

Water Temperature

Water temperature in streams plays a critical role in the health of the riparian ecosystem. Riparian vegetation maintains cooler water temperatures by shading the water surface and is particularly important in headwater streams that have a small volume of water (Binford and Buchenau 1993). Temperature influences factors such as the rate of nutrient cycling and

dissolved oxygen. For example, a slight increase in temperatures above 59° F will produce a substantial increase in the release of phosphorus (Karr and Schlosser 1978). Because phosphorus is often a limiting nutrient in freshwater systems, a substantial release of this nutrient can result in eutrophication which can reduce water quality and diversity of aquatic life. In addition, salmonid fish species and cold water macroinvertebrates require cool water temperatures in order to survive.

Wildlife Habitat

Riparian corridors are among the most productive wildlife habitats in many regions of the country (Noss 1993). They are particularly important habitats in arid and semi-arid landscapes (Szaro 1991; Thomas et al. 1979). Both wildlife species diversity and density are high in healthy riparian habitats (Noss 1993). Thomas et al. (1979) found that 75% of the terrestrial vertebrates in the Blue Mountain study area in eastern Oregon were dependent upon or preferred riparian habitat. Best and Stauffer (1980) found an average of 506 breeding pairs of birds per 100 acres in riparian corridors compared to 339 pairs in upland forests.

The vegetative community in most riparian areas is structurally more varied than adjacent landscapes and thereby provides a rich diversity of habitat niches. This diversity translates to the fulfillment of the primary life requisites (e. g.; food, cover, reproductive habitat) for a great variety of wildlife. Water, aquatic invertebrates, and fish provide resources that support species that inhabit and utilize an aquatic/upland ecotone.

Riparian vegetation adjacent to a stream is an



Tiger Salamander
Ambystoma tigrinum



important source of food for benthic macroinvertebrates which are a necessary food source for other forms of aquatic life. Detritus from leaves and herbaceous vegetation is consumed by these organisms as soon as it is deposited in streams while large woody debris provide long-term food reserves for aquatic life (Binford and Buchenau 1993).

In addition, the linear form of riparian areas may serve as critical wildlife corridors allowing for movement between different habitat areas (Forman 1995). Riparian corridors may be important for dispersal of juveniles (Noss 1993).

Recreation Benefits

Riparian areas are especially attractive locations for recreation, particularly for trails. The presence of water, diverse vegetation, moderated climate, and abundant wildlife enhance the recreation experience. Boating, rafting, kayaking, tubing, fishing, and hunting are popular activities in many corridors with perennial flowing water. Some riparian corridors have become so popular that demand frequently exceeds social and ecological carrying capacity. Conflicts between different types of users and degradation of the riparian resource often result (Cole 1993).

Economic Benefits

The economic value of these benefits is not always apparent and difficult to estimate. Thibodeau and Ostro (1981) used cost/benefit analysis techniques to calculate the value of riparian wetlands along the Charles River near Boston. They estimated the value of property value increase, water supply, flood prevention, pollution reduction, and recreation at between

\$153,000 and \$190,000 per acre. However, in the arid West, one quickly realizes that these resources are actually priceless.

STATUS OF RIPARIAN AREAS AND STREAMS

Despite the multitude of benefits that riparian areas provide, many of these areas have not been managed with care. For example, only about 2% of the Southwest landscape consisted of riparian ecosystems before Anglo settlement. Today, Arizona and New Mexico are estimated to have lost 90% of their riparian areas (Johnson 1989).

A nationwide study of fisheries in 666,000 miles of perennial streams revealed some very disturbing trends (Judy et al. 1984). For example, 40% of the stream miles were adversely affected by turbidity, 32% by elevated temperature, 22% by bank erosion, and 21% by excess nutrients. Approximately 75% of the stream miles would only support a low-quality sport fishery, and only 5 to 6% would support high-quality sport fishery.

While preservation and conservation of healthy streams and riparian areas should receive high priority, it is clear that restoration of degraded areas is a necessity as well. "If the damage to these ecosystems is not reversed, they will most likely undergo further significant, and in



Coyote Willow
Salix exigua





Chapter Two
*Understanding your
Stream and Watershed*



Understanding Your Stream and Watershed

some cases irreversible, ecological deterioration" (NRC 1992). This guide provides some tools to help reverse this trend.

WATERSHED APPROACH

Riparian areas are shaped by the dynamic forces of water flowing across the landscape. Flooding, for instance, is a natural and necessary component of riparian areas. Many riparian plant species such as cottonwood require floods to regenerate. Geomorphological characteristics of the stream valley such as floodplain level, drainage area, stream capacity, channel slope, and soils are some of the factors that influence the frequency, duration, and intensity of flooding (Leopold et al. 1964). Flooding, in turn, influences the size and structure of the stream channel and composition of the riparian vegetation (Hupp and Osterkamp 1996).

Healthy streams and riparian areas are naturally resilient which allows recovery from natural disturbances such as flooding (Florsheim and Coats 1997). Streambank stability is a function of a healthy riparian area. When a stream and riparian system is degraded, this resiliency to natural disturbances is diminished. Excessive flooding, erosion, and sedimentation will often increase. Degraded riparian areas are less effective for storing floodwaters. As more sediment is deposited, water quality is also diminished. High levels of sediment in a stream suffocate fish, fill in spawning gravels and pools, and kill aquatic insects (Platts and Rinne 1985).

..excessively eroding streambanks are only symptoms of an unhealthy stream, not the true cause of the problem.

As additional sediment is deposited in streams, the streambed may aggrade and become shallower, forcing water to spread out and cause bank erosion (Leopold 1994). Excessive bank erosion causes wider, shallower channels and lowers the water table. A shallower stream also has a lower dissolved oxygen content and a higher temperature, which supports less aquatic life.

In other streams, headcutting may occur, which is the cutting of the streambed to a lower bed elevation. As the streambed lowers, the water table also lowers. This causes riparian vegetation to die-off and be replaced with upland vegetation, which is less successful in stabilizing the streambank (Briggs 1996). In either case, headcutting or aggradation greatly diminishes the natural resiliency of riparian areas.

Riparian area health and streambank stability is simply a reflection of the conditions in the surrounding landscape. When studying your stream, it is important to keep in mind that extensive stretches of eroding streambanks are only symptoms of an unhealthy system and are not the true cause of the problems.

Consequently, to understand the factors that are affecting your stream, one must look at the whole watershed to gain an understanding of the big picture (Hunter 1990). A watershed is simply the area of land that drains into a particular stream. There are many factors that can contribute to an unhealthy watershed and riparian system. To adequately address these factors, an interdisciplinary approach is essential. Chapter 3 lists some of the professionals that should be consulted in determining the true source of the problems. In many cases, land management practices may be the primary source of problems.



PROPER LAND USE MANAGEMENT

Current and past land management practices in the watershed will affect runoff, streamflow and sediment load of a stream (Hunter 1990). This in turn influences the natural dynamics and health of stream and riparian areas. Common land uses in the Great Basin and Intermountain Region that can impact streams include agriculture, livestock grazing, timber harvest, road building, recreational activities, and urbanization (Briggs 1996; Platts and Rinne 1985; Schueler 1995).

The first step in any restoration process is to determine land management problems that created the unhealthy stream and riparian area. A change in management practices may be required to allow the stream to begin the healing process. In many instances, a change in land management practices is all that is necessary to restore the stream and riparian area to a healthy condition (Briggs et al. 1994; Hunter 1990; Kauffman et al. 1995). This type of restoration is often preferred because it is usually more cost-effective and will generally respond better to site conditions than a project that just relies on bioengineering techniques. However, carefully planned bioengineering techniques can be used in these situations to accelerate the restoration process. Where riparian areas are extremely degraded, bioengineering techniques may be necessary for

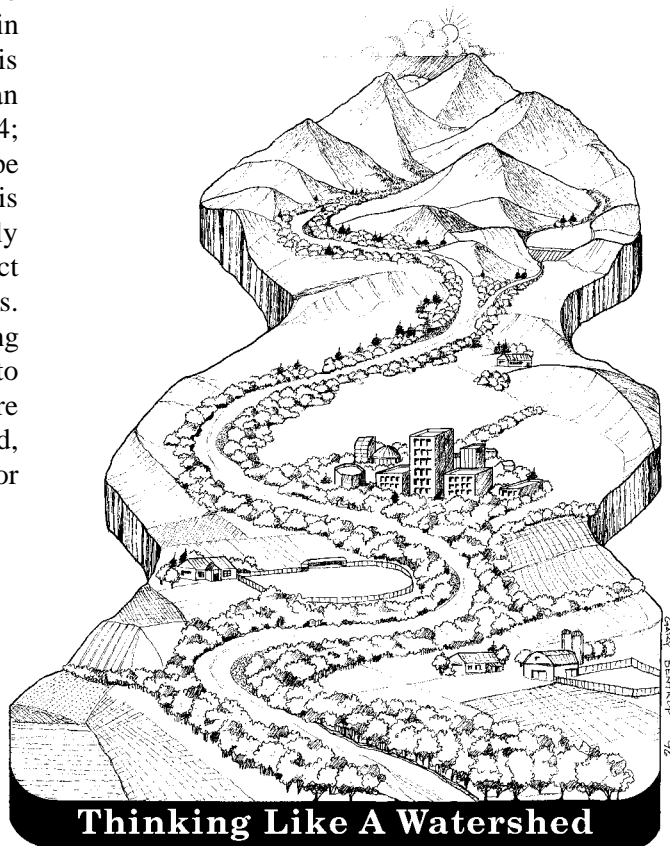
restoration, in addition to a change in land management practices.

It should be kept in mind that bioengineering should not be viewed as a substitute for proper land use management. Without changes in land management, the success of bioengineering efforts will most likely be short term.

The following section discusses common land use practices in the region and suggests basic best management practices to minimize the impact of these uses. A best management practice (BMP) may be defined as a structural and non-structural method to control erosion, improve water quality, and protect wildlife habitat. It is important not to rely only on one or two BMP because these practices are much more effective when applied in systems. It should also be noted that the discussion of specific BMP measures under one land use type

*"To protect your rivers,
Protect your mountains"*

*Emperor Yu of China
1600 BC*



Agriculture

Potential Impacts to Riparian Areas

1. Sedimentation
2. Polluted return flows
3. Altered hydrology
4. Riparian vegetation clearing
5. Channelization

Agriculture BMP

1. Crop residue management
2. Proper fertilizer management
3. Integrated pest management
4. Proper irrigation management
5. Riparian buffer strips

may also be applicable to another land use.

Additional references for proper land use management can be found in the Resources section of this guide.

Agricultural practices can strongly impact streams and riparian areas when proper management practices are not used (Binford and Buchenau 1993). Poor crop residue management and inefficient irrigation practices can contribute significant amounts of nutrients and sediment to streams. Altered hydrology due to irrigation diversions, stress riparian vegetation making it less capable of stabilizing streambanks (Briggs 1996). Another significant impact occurs where riparian areas are cleared to allow for more arable land. This removes vegetation that protects the land from erosion and reduces the natural filtering capabilities (Cooper et al. 1987). Channel straightening along cultural boundaries such as field borders often causes headcutting within the channel, lowers the water table, and increases sediment loads downstream.

Proper Agricultural Management

A comprehensive analysis of farming operations should be completed to identify

where BMP systems are needed and how they will protect riparian areas.

Crop residue management which increases infiltration and minimizes runoff should be encouraged, such as no or low-till cultivation practices (Harpstead et al. 1988).

Wise and efficient use of water is a key component of an effective conservation plan. Crops and soil should be carefully monitored to prevent excessive water application which will minimize runoff. Conserved water may be used to enhance a riparian area, which will promote higher base flows later in the summer (Stabler 1985).

A soil analysis should be completed to determine the proper timing and amount of fertilizer needed. Also, through better irrigation management, less fertilizer is generally required, resulting in cost savings (Harpstead et al. 1988).

Integrated pest management involves monitoring pests to determine optimum pesticide timing, use of alternative pesticides, and use of biological controls. Proper management reduces the potential for excess chemicals to leave the field and enter nearby streams.

A riparian buffer strip is an area of riparian vegetation that has been managed to provide



the many functions and benefits of these habitats (Shultz 1994). Riparian buffer strips generally consist of woody and herbaceous vegetation, that occur or are planted along the stream.

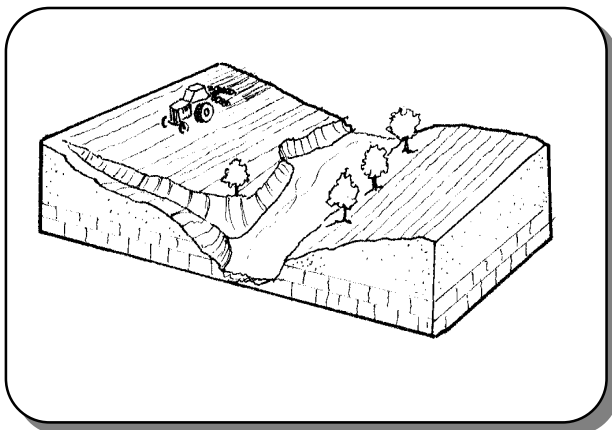
Diverse buffer strips containing a mixture of woody species such as willows, forbs, grasses, and grass-like species will often serve as effective filters of surface and subsurface water flows (Shultz 1994). It should be noted that in some areas, buffer strips with only herbaceous vegetation may be appropriate, i.e., where natural communities are dominated by sedges. Regional classification systems of riparian and wetland sites should be consulted such as *Classification and Management of Montana's Riparian and Wetland Sites* (Hansen et al. 1995), *Riparian Community Type Classification of Utah and Southeastern Idaho* (Padgett et al. 1989), and others.

In many degraded areas, the natural plant community may have been eliminated and may need to be replanted. Regional classification systems and riparian vegetation specialists will be able to help you to determine which species are appropriate for your area.

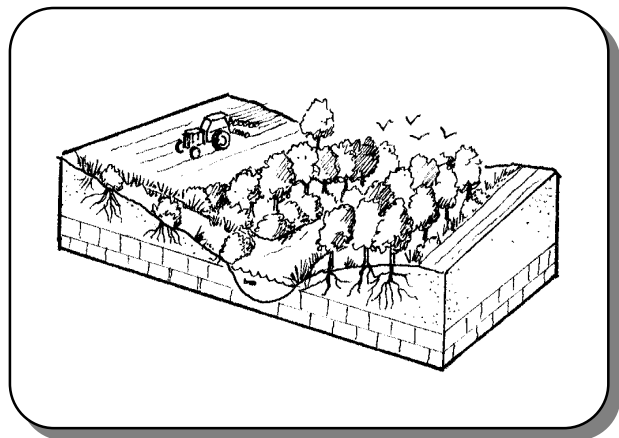
The width of riparian buffers varies depending upon soils, climate, vegetation, landuse, nutrient and sediment load, and the wildlife or fish species being managed for. Presently, research is being done on buffer widths in different parts of the country. However, at this time only estimates are available. In areas where the riparian area is intact, the width of the buffer should be at least the width of the existing riparian area and could possibly include an adjacent, small upland buffer. In areas where buffer strips are being created, a general rule-of-thumb is that buffer strips should be 2 to 5 times the width of the stream (Firehock and Doherty 1995). In general, a buffer should become wider as the stream increases in width and flow.

It should be kept in mind that other BMPs should be used in concert to avoid overloading the capabilities of the riparian buffer strip.

Check with your local NRCS District Conservationist for assistance and additional information on BMPs and cost-share programs for implementing conservation plans.



Without Protection and Management



With Protection and Management



Livestock Grazing

Potential Impacts to Riparian Areas

1. Sedimentation
2. Nutrient-laden runoff
3. Overgrazed vegetation
4. Riparian vegetation trampling
5. Bank destabilization

Since livestock are naturally drawn to riparian areas in the West, improper grazing management has resulted in a major impact to streams and riparian areas in the region (Briggs 1996; Johnson and Jones 1977; Platts and Nelson 1985; West 1995).

Overgrazing of riparian vegetation results in streambanks being more vulnerable to the effects of livestock trampling and to the erosive force of water. Reduced vegetation exposes soils to drying by wind and sunlight, reduces water storage capacity, accelerates runoff, and reduces infiltration (Cannon and Knopf 1984; Kauffman and Krueger 1984). Overgrazing also encourages the invasion of weedy species and reduces shade and thereby increases water temperature (West 1995).

Overgrazing uplands may also impact the health of the stream even if the riparian area is protected. Overgrazed uplands can contribute higher sediment and runoff quantities than properly grazed uplands (West 1995). Consequently, it is not a matter of better grazing management for riparian areas, but rather a holistic grazing plan for all areas. The goal should be a grazing system that protects riparian areas while improving long-term financial return. Restoring degraded riparian areas may create new sources of income such as

Grazing BMP

1. Fenced riparian buffers
2. Prescribed grazing management
3. Alternative water sources
4. Other structural improvements

fees collected from hunters and other outdoor recreationists (West 1995).

Proper Grazing Management

Where riparian habitat is severely degraded, complete rest is more effective and quicker than trying to manage grazing during the first few years (Cannon and Knopf 1984; Platts and Wagstaff 1984).

Fencing the riparian area (and possibly some adjacent upland) to control livestock and wildlife access is one of the most effective ways to accomplish this goal. Research has shown that riparian habitat often improves quickly when fenced to exclude grazing or to control the time and duration of grazing. This applies to wildlife as well as livestock. Duff (1980) reported that riparian habitat grazed all season long remained in poor condition while adjacent ungrazed riparian habitat attained good condition within 4 years. Another study showed that a reach of Horton Creek in Idaho, which was overgrazed by sheep, was 4 times wider and only 1/5 as deep as an adjacent but fenced stream reach (Platts 1981). Some research, however, has shown that riparian recovery may not be quick if the riparian system is severely degraded (Clary et al. 1996; Clary 1995).



One of the most daunting aspects of fence construction is the labor required. Volunteer labor for riparian fence construction has been used successfully on both private and public lands (West 1995). Managers should investigate the opportunity of using volunteers such as Fish and Game volunteers and NRCS Earth Team members.

When installing fences, managers should resist the temptation to put fences at the high water line. The fenced areas should include enough land to restore riparian and stream function and allow the stream to shift naturally over time. In addition, upland areas included in riparian pastures can decrease livestock impacts by providing more acreage for the livestock to use especially during the spring grazing season. A monitoring program should be established to determine when the riparian area has healed sufficiently to allow grazing. In some cases, it may be desirable not to graze riparian areas in the long run because of the benefits a healthy riparian areas will return to the overall operation (Platts and Wagstaff 1984). For example, a ungrazed riparian zone may sustain higher base flows later into the summer (Stabler 1985; West 1995).

The foundation of any prescribed grazing



Geyer Willow
Salix geyeriana

program is a documented plan with identified goals and objectives. The key components of this management plan should address timing, intensity, and duration of grazing (Chaney et al. 1993; West 1995). Several grazing strategies incorporate these and other factors to minimize impact on streams and riparian areas (Chaney et al. 1993; Platts 1990). Many of these strategies are based on avoiding riparian areas when soils are saturated and susceptible to compaction and bank collapse. Some plans are based on rotating livestock from one pasture to the next during the year. A key component of successful grazing plans is carefully planned pastures which can be given rest from livestock grazing during a critical time. By having riparian areas fenced in separate pastures from the uplands, grazing can be carefully controlled.

Another strategy is to minimize the time livestock spend in riparian areas by creating desirable conditions in upland areas (West 1995). These include structural measures such as water facilities and shelters. Providing water in uplands can assist in luring livestock away from riparian areas. Shelters or shade which provide protection from the elements should also be placed in strategic upland locations. Using salting locations in uplands may assist in drawing livestock from riparian habitats. Improving upland forage desirability through seeding and other techniques may also be incorporated in the management plan.

Range conservationists that understand riparian areas and livestock management should be consulted in preparing a grazing management plan to improve the entire operation and associated ecosystems.

A RESTORATION TOOL: BEAVER



Timber Production

Potential Impacts to Riparian Areas

1. Sedimentation
2. Stream crossings
3. Riparian vegetation clearing
4. Increased runoff

Forestry BMP

1. Riparian buffers
2. Proper roadway design
3. Proper stream crossings
4. Sustainable logging strategies

Although, timber harvesting activities usually occur in upland areas, logging practices can significantly impact streams and riparian areas (Firehock & Doherty 1995). Poorly designed and constructed access roads contribute large quantities of sediment to streams. Because riparian valleys usually have a flatter gradient than upland areas, roads are commonly aligned along streams, resulting in the clearing of riparian vegetation and other impacts. Timber harvesting methods that significantly reduce vegetation such as clear cutting, can contribute to higher sediment and runoff quantities. It can also increase peak flows due to lack of canopy allowing snowpack to melt quicker.

Proper Forestry Management

BMPs are available to reduce the impact of timber harvesting (Seyedbagheri 1996). Every few years, national forests must prepare a forest management plan which addresses the forestry practices in use. These plans are available for public review and comment. In addition, several states have forest practices acts which influence timber harvest practices in that state. Through existing laws and public participation in the planning process, BMPs can be applied to timber harvesting activities.

Riparian buffers, which were covered under the

earlier sections, should be applied in all timber harvest locations. Essentially, the buffer should be as wide as the natural riparian area and should include some upland area. This should not be a problem because many riparian tree species have low economic value to the timber industry.

New access roads should be designed to avoid riparian areas. Although construction costs may be initially higher, lower maintenance should provide cost savings in the long run. Stream crossings should be avoided whenever possible.

When stream crossings are inevitable, new crossing designs are available to minimize impact. Refer to the *Riparian Road Guide* in the Resource section for ideas. This guide also provides valuable ideas on retrofitting existing roads with better stream crossing designs. In some cases, it may be appropriate to restore existing roads back to natural conditions.

Finally, the actual logging practice should be examined to see how timber can be harvested in a manner that protects all of the forest resources. A forester should assist with development of an appropriate logging strategy.



Urbanization Land Use

Potential Impacts to Riparian Areas

1. Polluted runoff
2. Increased runoff
3. Clearing of riparian vegetation
4. Riparian vegetation trampling
5. Channelization

Urbanization BMP

1. Avoidance of riparian areas
2. Riparian buffers
3. Reduce impervious cover
4. Limit disturbance and erosion of soils
5. Treat stormwater runoff

Urbanization has often resulted in serious impacts on streams and riparian areas (Binford and Buchenau 1993). In recent history, streams were considered a problem rather than an asset in communities. Consequently, streams were often channelized to reduce flooding and offered a means of getting rid of sewage. Ironically, these practices increased flooding and associated problems for all of the communities in the watershed.

Impervious surfaces such as massive parking lots increase runoff and flush pollutants into streams (Schueler 1995). In urbanizing areas, riparian vegetation is often cleared away for construction. Even in cases where some areas are protected from development, heavy recreational use has resulted in trampled riparian vegetation (Cole 1993).

Although a majority of the Great Basin and Intermountain West is rural, many urbanizing communities in the region already have impacted streams and riparian areas. Restoration of these habitats should be considered for the benefit of the community and the environment (Briggs 1996). Because rapid growth is beginning to occur in the region, growing communities should take a pro-active role in protecting their riparian resources.

Urban Land Use Management

Protection of stream and riparian areas in urbanizing environments is a holistic process that must encompass the whole range of the development sequence (Schueler 1995). Communities cannot rely on one BMP to protect their riparian areas.

The first step is to inventory streams and riparian areas in the community. This includes ephemeral streams that may only flow intermittently. These habitats still play a significant role in the arid West and should be protected from development by narrow buffers. Protection can occur in a variety of ways such as land acquisition or conservation easements.

A stream buffer system should be considered in communities (Herson-Jones et al. 1995). In some communities, a three level buffer system have been effective where different uses are allowed in each zone. For example, the first buffer zone adjacent to the stream could be primarily for natural functions to occur and would not allow many uses. The second zone placed farther back from the stream could allow some recreational uses such as pathways. The third zone, farthest away from the stream, would allow more uses. When this three-level



approach is not applied, many buffers become an extension of the adjacent landowner's yard. When these areas are treated as lawns, the benefits of the buffer are greatly diminished (Schueler 1995).

Impervious cover alters the natural hydrology of an area. Runoff is quickly conveyed to streams which results in higher peak flows and reduces the dry season base flows. Impervious cover in communities consists of everything from rooftops and sidewalks to parking lots. Some research shows that stream and riparian degradation occurs at relatively low levels of imperviousness from 10 to 20% per unit area of land (Schueler 1995).

Two main approaches can be used to deal with impervious cover. First, stormwater drainage should be shifted to infiltration and dispersal methods rather than allow runoff to concentrate. Impervious cover should be connected to infiltration trenches and recharge basins rather than piping it to a discharge point along a stream.

Second, the amount of impervious cover in a community should be reduced. This will require creative design and cooperation among designers, developers, and city officials. Methods to reduce impervious cover include zoning measures, realistic street and parking lot design requirements, use of porous paving materials, cluster development, and shared parking facilities.

To illustrate the cooperative nature of this endeavor, an example is a bank which is not open on Sundays, allows an adjacent church to use the parking facilities.

Communities should consider limiting disturbance and erosion of soils during construction.

The timing and amount of ground that can be exposed at a given time can be controlled to minimize erosion. Effective erosion and sediment BMPs can also be applied. The International Erosion Control Association can offer guidance in this area (see Resource section).

After these measures have been applied, it may still be necessary to treat stormwater before it enters the riparian area. Stormwater treatment systems that allow for natural infiltration and recharge into the aquifer after treatment are a good option in our arid environment. Other worthwhile treatment systems include constructed wetlands, vegetated swales, and filter strips.

Urban stream and riparian protection is a complex and interrelated process that requires the involvement of professionals, city officials, and the community. Most importantly, it must be supported by the community at large.

A particularly good resource for this process is the book, *Site Planning for Urban Stream Protection* by Schueler (1995) which can be found in the Resource section of this guide.

Stream and riparian degradation often occurs when impervious cover reaches 10-20% in a watershed.

(Schueler 1995)



The use of beaver to restore riparian areas and recharge waters in rangelands and other areas is an excellent example of using natural processes (West 1995). Some believe beaver are the reason for riparian destruction. If this were the case, beaver would have eliminated every streamside tree in North America prior to European settlement. Obviously, this did not happen. Riparian areas developed with beaver and they are part of the natural dynamic equilibrium.

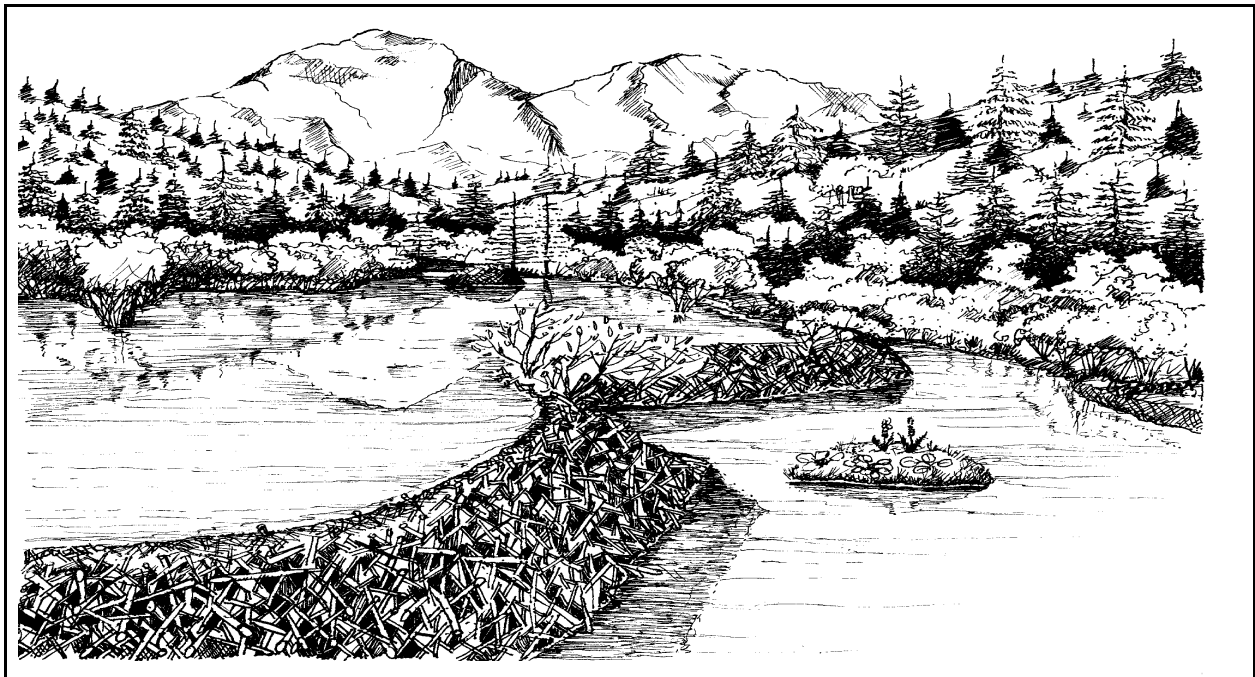
The dam-building behavior of beaver makes them effective riparian managers. Their dams trap sediment and pond water. This raises the local water table and slows down the overall velocity of the stream. In some areas, beaver have helped maintain year-round flow, even during periods of drought. More water is then available for livestock and wildlife. Because ponding raises the water table, a lush riparian area will often develop, which benefits livestock and wildlife. Beaver ponds also store spring runoff, often reducing the effects of

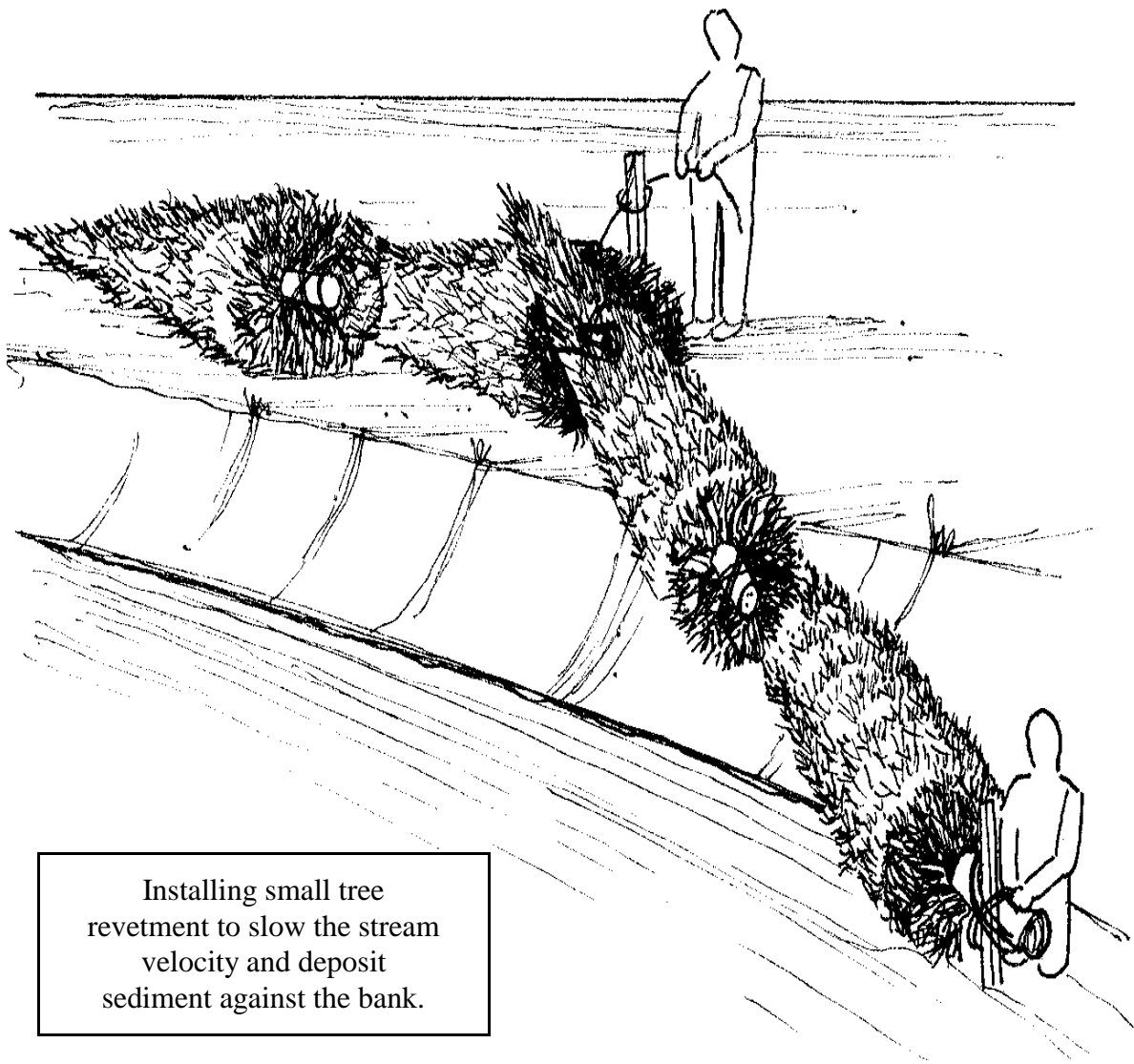
seasonal downstream flooding.

Areas chosen for beaver reintroductions should have perennial flows no less than 0.5 cfs, channel slopes 3 percent or less, and adequate woody vegetation for food and construction material (West 1995). Large rivers, (4th order and higher) are probably not appropriate for beaver reintroductions. In some areas, it may be necessary to allow the woody vegetation to recover before bringing in beaver.

After beaver have been reintroduced, the new colony needs to be protected for the first 3 years while becoming established. After this time, some beaver should be harvested because natural predators are no longer as abundant as historically.

Those interested in reintroducing beaver should contact their state fish and game agency.





Installing small tree
revetment to slow the stream
velocity and deposit
sediment against the bank.

Chapter Three

Streambank Bioengineering



Streambank Bioengineering

BIOENGINEERING: ADVANTAGES AND DISADVANTAGES

Bioengineering can be defined as integrating living woody and herbaceous materials with organic and inorganic materials to increase the strength and structure of the soil. This is accomplished by a dense matrix of roots which hold the soil together. The above-ground vegetation increases the resistance to flow and reduces flow velocities by dissipating energy. The biomass also acts as a buffer against the abrasive effect of transported materials and allows sediment deposition due to low shear stress near the bank (Allen and Leech 1997).

In contrast, traditional engineered approaches to streambank stabilization include rip-rap, concrete revetments, bulkheads, concrete-lined channels, etc. These hard structures require some maintenance over the course of their usable lifespan. In addition, failure of a hard structure can be even more expensive to repair than the original construction costs. Bioengineering projects may be expensive initially, especially for labor, replanting, possible repairs, and monitoring. However, their maintenance costs will be significantly lower over time because of their resiliency and self-sustaining nature (Allen and Leech 1997).

Bioengineering techniques have a long history in central Europe where these practices have been used along small to large streams (Schiechl and Stern 1994). In the United States, wattles and other bioengineering techniques were used in the 1930s (Kraebel 1936; Fry 1938). However, these techniques were largely ignored until recently and now are being applied in a variety of settings (Bentrup 1996; Gray and Sotir 1994; Hoag 1992; Rotar 1996).

Bioengineering projects do have some limitations (Gray and Leiser 1982; Schiechl and Stern 1994): 1) sometimes the plants fail to grow, 2) plants and other components may be subject to scouring, 3) plants can be uprooted by freezing and thawing, ice flows, and debris loads, 4) livestock and wildlife often feed on the plants and may destroy them, and 5) the project may have to be maintained for a period of time, especially early in the project life.

Despite these limitations, a bioengineering approach offers several advantages over traditional approaches (Gray and Leiser 1982; Schiechl and Stern 1994). Some of these advantages include:

Cost Effectiveness

As previously stated, typical bioengineering techniques are more cost-effective than hard engineered structures. Even when considering the occasional need to reinstall a bioengineered treatment (e.g. one which did not have time to establish roots before a flood), these techniques are usually less expensive in the long run. As a bioengineering project matures, little to no maintenance will be required.

Environmental Compatibility

Bioengineering techniques blend into the landscape, providing valuable fish and wildlife habitat. These methods improve water quality rather than diminish it like traditional approaches. These techniques will also evolve with the stream, adjusting naturally to flows and meandering.

Indigenous, Natural Material

Bioengineering techniques emphasize the use of natural, locally available materials: earth, vegetation, rock, and lumber in contrast to steel



and concrete. This is a particularly important consideration in more remote areas where it is infeasible to bring in artificial materials.

Labor-Skill Requirements

A final but important consideration is that bioengineering techniques tend to be more labor-skill intensive than energy-capital intensive (Gray and Leiser 1982). These techniques depend more on easily trained labor than on high-cost manufactured materials. As a result, these methods can be installed with well-supervised volunteers. Acquiring volunteers for these types of projects is usually quite easy. Potential volunteers include high school groups, fish and game volunteers, NRCS Earth Team members, Boy and Girl Scouts, etc. In addition to the free labor, there is significant value in having people play a role in restoration. Stream restoration can instill a sense of ownership and care for the region's riparian areas (Lev 1995; McDonald 1995).

Characteristics of Bioengineering

Vegetation Components

Bioengineering techniques typically rely on woody plant materials because of their deep root system that reinforces the soil and their greater resistance to erosive flows. Herbaceous plant materials should also be used because they provide fine fibrous root systems. When herbaceous plants are used with woody vegetation, the combination will hold more soil and will buffer the force of the stream as it hits the streambank. Wetland herbaceous plant species also survive in areas of the streambank that have more water than the woody species can handle. Wetland plants can survive these conditions because of their aerenchyma cellular structures which move oxygen to the root systems and allow them to grow in anaerobic conditions.

Structural Components

These techniques often use non-living material

Planning a Bioengineering Restoration Project

1. Analyze the watershed and determine the large scale reasons for degradation.
2. Work with the landowners to modify poor land management practices as necessary.
3. Enlist technical expertise and begin initial inventory of areas that may benefit from bioengineering. Begin to develop site-specific objectives.
4. Inventory and analyze prospective sites and determine causes of bank failure. Select a project site and refine objectives.
5. Design a site-specific bioengineering project to meet the objectives.
6. Gather input and permits as necessary from regulatory agencies.
7. Implement the project.
8. Monitor and maintain the project. Evaluate for future projects.

such as wood and steel stakes, wire, twine, etc. Sometimes these methods utilize specially manufactured products such as biodegradable coir fiberschines and erosion control fabric. Other non-biodegradable products such as plastic geogrid cells may be appropriate in certain applications.

BASIC PLANNING AND DESIGN PRINCIPLES

The above list illustrates the basic procedure for planning a bioengineering restoration project. **STEPS 1 and 2** were covered in Chapter Two.

STEP 3 PRELIMINARY INVENTORY



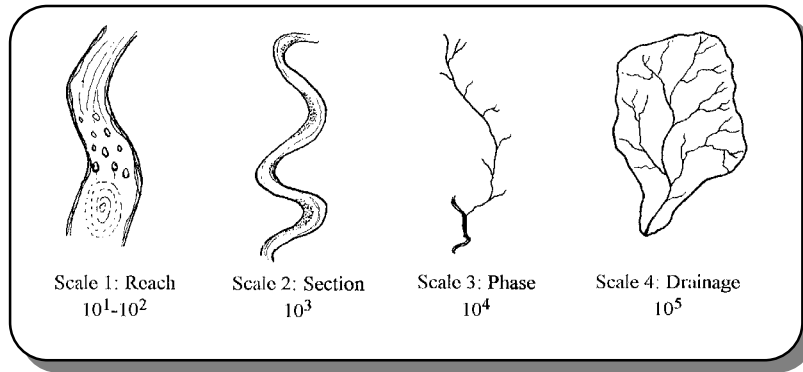


Fig. 3.1 Multiple Scales of Inventory and Assessment. Numbers indicate approximate spatial extent in 10's of feet. (Modified from Stanley et al. 1997).

Enlist Technical Expertise

This step is essentially a review of the areas in a watershed which could benefit from having a bioengineering project. It is often worthwhile to enlist technical expertise at this point in the process to select sites that are suitable for bioengineering. An interdisciplinary team is always recommended. This team may consist of professionals like engineers, fluvial geomorphologists, grazing lands specialists, plant ecologists, fish and wildlife biologists, soil scientists, hydrologists, and landscape architects.

Also include local landowners and officials from regulatory agencies in the process. It is critical to involve individual landowners in the identification of any land management problems so that holistic solutions and support can be created. Including all of these people in the planning process will give them ownership in the project and will result in better restoration alternatives.

Multiple Scales of Inventory and Assessment

*Eventually, all things merge into one.
And a river runs through it.*

Norman MacLean

It is important to emphasize that restoration projects must incorporate several scales of inventory and assessment. Stanley and others (1997) provide a useful hierarchical framework for inventorying streams (Fig. 3.1).

In Step 3, the inventory should be focused at the watershed and phase scales. According to the framework by Stanley and others (1997), the spatial extent of the stream being inventoried at these scales would range from approximately 5 to 50 linear miles, although this will vary based on the context of the area. The main objective of the inventory at these scales is to highlight land management issues that may need to be addressed. In addition, this assessment should provide an understanding of the major problems and opportunities that exist in the watershed. Aerial photos that cover several decades may be extremely valuable tools for this process.

Potential sites identified during this step will be more thoroughly inventoried and analyzed at a finer scale in Step 4. At the section and reach scales, the spatial extent of the inventory may range from approximately 10 feet up to 1 mile. Again, these ranges may vary depending on the situation. The main objective of this inventory is to gain insight into the site specific problems and opportunities.

Successful bioengineering projects are often dependent upon the careful integration of inventories and analysis conducted at multiple scales.

Initial Inventory: Geomorphic Valley Form



Fluvial geomorphology is the study of flowing water as it shapes the landscape. Riparian zones are the result of hydrologic and geomorphic conditions where water, energy, and materials from aquatic and upland ecosystems converge in a channel.

Bioengineering projects that fail usually lack an adequate multi-scale assessment of the fluvial geomorphic processes at work. It has been suggested that design teams should use geomorphic valley-forms for the Great Basin as described by Minshall and others (1989) as an initial guide in determining the feasibility of a bioengineering project (Carlson et al. 1995). Table 3.1 (pp. 20-21), based on the work by Carlson and others (1995) can be used as an initial guide.

The six classes of geomorphic valley-forms are glacial headwaters, glacial valleys, erosional fluvial canyons, depositional fluvial canyons, alluvial valleys, and lacustrine basins. The geomorphic valley forms can be correlated to the stream types described by Rosgen (1994), to vegetation community types described by Padgett and others (1989) and inferred from Brunfeld and Johnson (1985). Under this correlation, alluvial valleys are subdivided into a mid- and low-elevation category, and braided stream channels are dealt with separately.

Developing Objectives

One the most important aspects of any restoration project is the development of specific objectives. By having firm objectives for the project, the chance of success increases dramatically. The entire project area should be considered and potential problems anticipated. At this stage in the process, preliminary objectives should be established and then refined in the next step as a specific site is selected. Hoag (1993) noted several factors that may be considered when developing objectives:

* If a decrease in water temperature and

improvement of fish habitat are part of the project objectives, shade can be increased with tall and/or wide canopy species planted on the south side of the stream. A mixture of shrubs, short and tall trees may provide the most shade.

* If wildlife habitat is desired, determine the species of wildlife and their needs. Wildlife diversity is usually enhanced by having several vegetative layers; i.e. groundcover, mid-canopy and overstory. Habitat for food, shelter, nesting cover, brood habitat, and hiding cover should be determined and incorporated in the design.

* Select plant species that have low palatability if the site is an area where grazing (livestock or wildlife) is not desired.

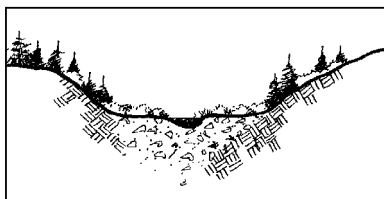
* If aesthetics are a part of the objectives, select species that flower in different months and that have colorful berries, fruits, and fall color.

* If the revegetation site is an area where views are important, low growing shrubs might be more appropriate than taller shrubs and

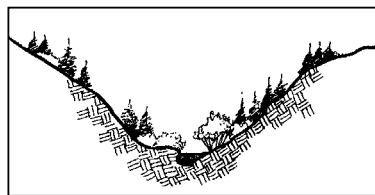


Table 3.1 Geomorphic Valley Forms

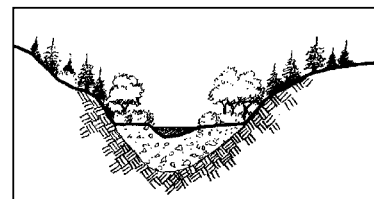
Valley Form	Stream Characteristics		
	Gradient and Flow	Rosgen Type	Additional Information
Glacial Headwaters and Valleys	Small, low gradient. Low order stream in U-shaped valleys.	C and E	Highly permeable substrate minimizes flooding during high precipitation events.
Erosional Fluvial Canyons	High gradient. Low to mid-order streams in V-shaped canyons.	A	Highly confined, may be downcutting.
Depositional Fluvial Canyons	Moderate to high gradient. Low to mid-order streams in V-shaped canyons where deposition has occurred.	B	Moderate to highly confined with restricted meandering. Flow regimes are widely fluctuating.
Braided Stream Channels	Moderate gradient. Often located where fluvial canyons empty into broad valleys and deposit coarse sediment.	D	These zones are naturally highly erodible.
Mid-elevation Confined Alluvial Valleys	Low gradient. Small to medium-sized low to mid-order streams.	C	Moderately confined. Usually at 5,000 to 7,000 feet elevation in north, higher moving south in the region.
Low-elevation Unconfined Alluvial Valleys	Low gradient and highly sinuous.	C	Slight to no confinement. Evaporation is high in Great Basin valleys.
Lacustrine Basins	Slow moving, low gradient. Often ephemeral streamflow.		May terminate in a saline lake, dry lake bed, or playa. Soil conditions often very saline.



Glacial Headwaters and Valleys



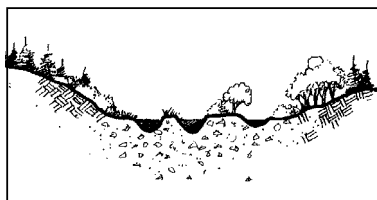
Erosional Fluvial Canyons



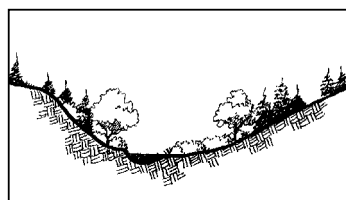
Depositional Fluvial Canyons



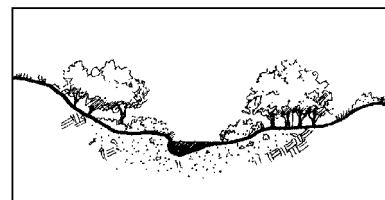
Vegetation	Revegetation Potential
Primarily herbaceous wetland species (<i>Juncus</i> , <i>Carex</i> , <i>Eleocharis</i>) with levees and hummocks supporting low-growing willows; planeleaf willow (<i>Salix planifolia</i>) and wolf willow (<i>S. wolfii</i>).	Moderate revegetation potential due to high elevation and short growing season.
Narrow band of riparian vegetation, primarily deep-rooted species: river alder (<i>Alnus incana</i>); water birch (<i>Betula occidentalis</i>); common shrubs include: dogwood (<i>Cornus spp.</i>) chokecherry (<i>Prunus virginiana</i>) geyer willow (<i>Salix geyeriana</i>) and booth willow (<i>S. boothii</i>).	Relatively low due to high flow velocities, erosion rates and/or rock. Rely on bioengineering methods that include adequate protection of plantings.
Stream terraces support river alder, water birch or cottonwoods: (<i>Populus trichocarpa</i> , <i>P. angustifolia</i> , <i>P. fremonti</i>); common shrubs include: dogwood, chokecherry, geyer and booth willow. Other willows include: whiplash willow (<i>S. lasiandra</i>), coyote willow (<i>S. exigua</i>) and drummond willow (<i>S. drummondiana</i>).	Relatively low due to high flow velocities, floodplain scouring and/or rock. Rely on bioengineering methods that include adequate protection of plantings.
Gravel bars and secondary channels may support cottonwood, coyote willow, and other species that establish on freshly deposited sediment.	Poor to fair; plantings are vulnerable to channel shifting; stream should be allowed to move as needed. Consider establishing and maintaining parent trees and shrubs as seed sources if large areas are denuded.
Booth and geyer willow dominate many communities on soils too waterlogged for deeper rooted alder, birch, and cottonwood; deeper rooted species may occur on small terraces.	High using booth and geyer willow as primary species for bioengineering treatments; river alder, water birch, and cottonwood may be planted where site conditions permit,
Black cottonwood (north and west), narrowleaf cottonwood (east), and Fremont cottonwood (south), are very common. Commonly associated with coyote willow and yellow willow (<i>S. lutea</i>).	High, using native cottonwood or willow; a typical planting along medium sized streams would include willows at the waterline and cottonwoods with understory shrubs on the upper banks and low terraces.
May include cottonwood and willow if in freshwater environment or salt-tolerant non-native, invasive species such as saltcedar (<i>Tamarix spp.</i>) or Russian olive (<i>Elaeagnus angustifolia</i>).	High using native species where conditions are not excessively saline.



Braided Stream Channels



Mid-elevation Confined Alluvial Valleys



Low-elevation Unconfined Alluvial Valleys and Lacustrine Basin



trees.

STEP 4 DETAILED INVENTORY AND ANALYSIS.

In this step, the areas should be inventoried and analyzed and a site with the most potential for improvement should be selected. The interdisciplinary team should consider factors such as topography, soils, climate, hydrology, vegetation, fluvial geomorphology, and geotechnical considerations as well as other factors deemed necessary by the design team. The following is a brief discussion of the type of data the team should collect and record on a base map (Fig. 3.2). A base map can be created by enlarging the project area from an U.S.G.S. 7.5 minute quadrangle map.

Topography

1. Determine degree of streambank slope in stable and unstable areas to assess a suitable angle of repose. Generally, final slopes should not exceed a 3H:1V slope.

2. Determine site-accessibility to stage materials such as brush and rock for revetment techniques.

Soils

1. Analyze soil type and depth for revegetation activities. Take soil cores to see what type of layers are present. It is difficult to get successful rooting in thick clay layers.

2. Other soil factors to consider include compaction, crusting, pH, fertility, organic matter, and special limiting conditions such as sodic, acidic, calcic, or saline soils.

Infertile, inorganic, and poorly drained subsoils can make the establishment of vegetation very difficult. Compacted soils are often saturated with high levels of carbon dioxide and may be deficient in oxygen, thus making plant establishment difficult.

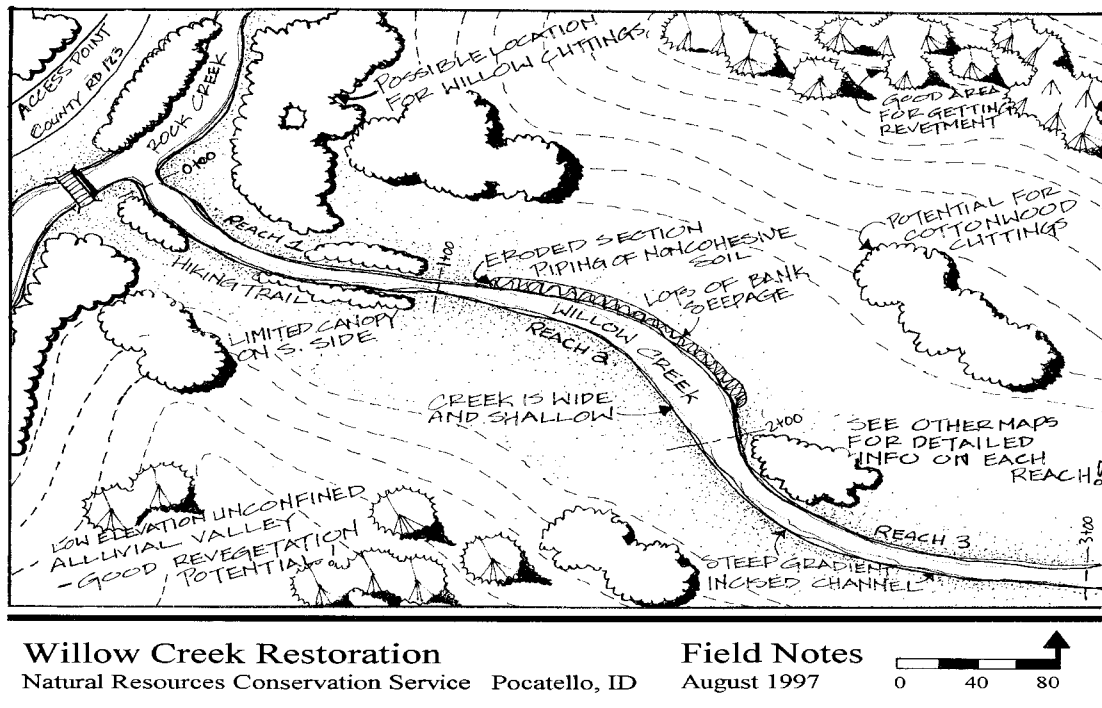


Fig. 3.2 Base Map with Field Notes



Soil pH, either high or low, causes many problems with nutrient deficiency or toxicity (Munshower 1993). Limiting conditions such as sodic, acidic, calcic, and saline conditions are detrimental to root and shoot growth. Few plants are tolerant of these conditions. Plantings in these types of soils are rarely successful when conditions are extreme and only moderately successful if care is taken to use plants tolerant to these limitations.

Climate

1. Regional climate data should be collected and assessed for impacts on the proposed project, particularly in regards to planting. The USDA Plant Hardiness Zone Map (USDA Agricultural Research Service 1990) delineates zones in which day length, radiation, temperature, frost, heat, and rainfall are described.
2. It is critical to inventory microclimates at the project scale, because these can be very different from average regional climates. Microclimates are the result of local physical and biological factors in relation to climatic

factors. For example, a south facing streambank receives more solar radiation than a north facing slope which will influence soil moisture conditions.

Hydrology

1. If the stream has a gauging station, the flow data should be analyzed for peak flows up to the 100-year flow frequency and late summer low flows.
2. If there is no gauging data, qualitative information can be collected from local residents and field indicators along the channel. Field indicators include old flotsam lines, water level markings on rocks and changes in the vegetation community.
3. Determine bankfull discharge also known as the channel forming flow. Bankfull discharge is the flow event where the flow is at the top of the point bar and ready to enter the floodplain and typically occurs every 1.5 years (Leopold 1994). In many incised streams, the flows may not be able to leave the channel due to entrenchment. In this case, it is still advisable to know where

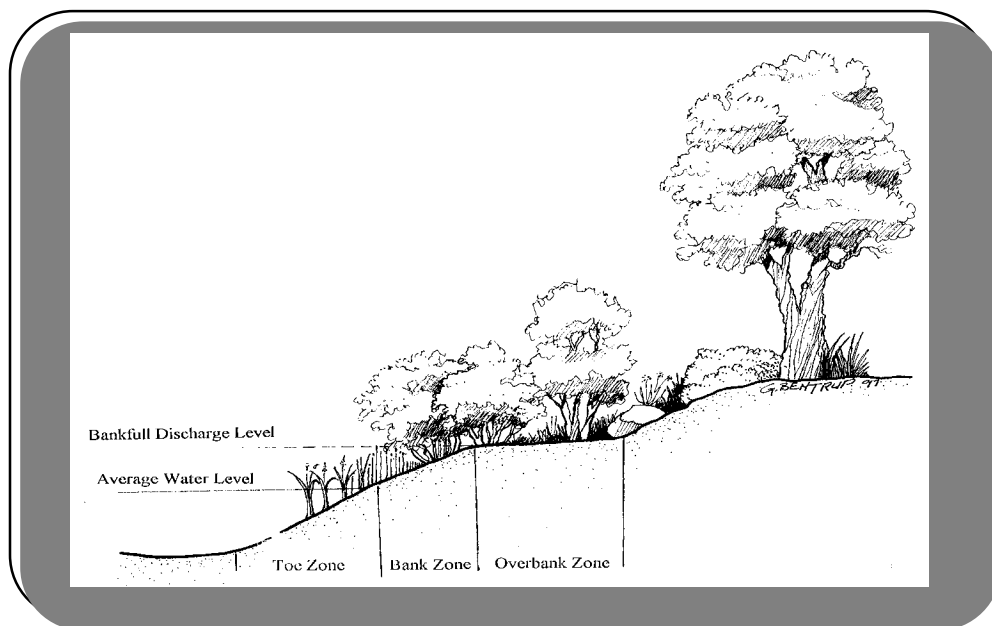


Fig. 3.3 *Streambank Zones and Bankfull Discharge*



the top of the flow is for a 1.5 to 2 year event for design purposes (Fig. 3.3). The video, *A Guide to Field Identification of Bankfull Stage in the Western U.S.*, may be a useful tool for this task and is referenced in the Resource section.

4. Determine discharges and flow velocities of peak flow events. Often 2-, 5-, 10-, and 100-year return intervals are evaluated to determine design parameters associated with these events.

5. Determine late summer or permanent water-table levels for vegetation planting. Piezometers or shallow groundwater wells constructed of perforated PVC pipe may be used to monitor groundwater levels (Briggs 1996) (Fig. 3.4).

Vegetation

1. Inventory the vegetation in the area to determine suitable species for the restoration project. In degraded areas, historical data and professional judgment will be required to create a planting list.

2. Locate healthy vegetation communities in the area where cuttings may be harvested for the bioengineering techniques.

3. Determine where the different species occur in relationship to the stream channel and water table (Refer to Fig. 3.8 and Fig. 3.9). Use this as a biological benchmark for the restoration plan.

Fluvial Geomorphology and Geotechnical Factors

Streambank Zones

Johnson and Stypula (1993) provide a useful classification of streambank zones: the toe, bank, and overbank zones (Fig. 3.3).

Toe Zone. The toe zone is the portion of bank that is between the average high water level and the bottom of the channel at the toe of the bank. This zone is the most susceptible to erosion since it is inundated most of the year and experiences strong flows, wet-dry cycles, ice jams, and debris flows. Most of the bioengineering projects that fail inadequately address the erosive forces in the toe zone (Allen, pers. com.).

Bank Zone. The bank zone is that area between the average water level and the bankfull discharge level. This area will experience periodic erosive flows. In entrenched stream systems, the historic bankfull discharge volume may no longer reach the top of the bank due to downcutting.

Overbank Zone. The overbank area is situated above the bank zone and is traditionally considered the floodplain. This area only receives erosive flows during flooding events and commonly experiences dry periods.

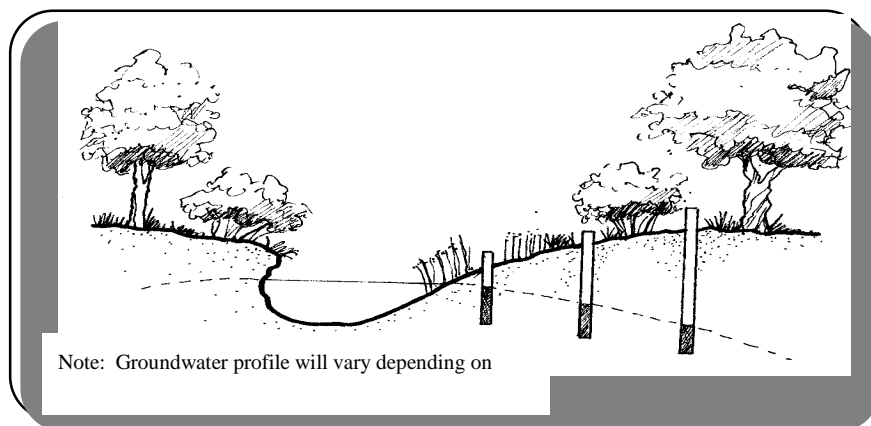


Fig. 3.4 Groundwater Monitoring Wells



Streambank Composition

Streambank failure is closely related to the composition of the streambank material. Although these materials can be highly variable, they can be broadly divided into four categories. Johnson and Stypula (1993: pp 3-2) describe each as follows:

Bedrock. Outcrops of bedrock are generally quite stable; however, they can cause erosion in the opposite bank if it is softer material.

Cohesionless Banks. Cohesionless soils are heterogeneous mixtures of silts, sands, and gravels. These soils have no electrical or chemical bonding between particles and are eroded particle by particle. Erosion of cohesionless soils is determined by gravitational forces, bank moisture, and particle characteristics. Factors influencing erosion also include seepage forces, piping, and fluctuations in shear stress.

Cohesive Banks. These banks generally contain large quantities of clay particles which create a higher level of bonding between the particles. Consequently, cohesive soils are more resistant to surface erosion because they are less permeable. This reduces the effects of seepage, piping, and frost heaving. However, because of low permeability, these soils are more susceptible to failure during rapid drawdown of water levels due to the increase in soil pore water pressures.

Stratified or Interbedded Banks. These banks are generally the most common bank type in fluvial systems because of the natural layering process. These soils consist of layers of materials of various textures, permeability, and cohesion. When cohesionless layers are interbedded with cohesive soils, the erosion potential is determined by the characteristics of the cohesionless soil. When the cohesionless soil is at the toe of the bank, it will generally

control the erosion rate of the overlying cohesive layer (Fig. 3.5). When a cohesive soil is at the toe of the slope, it will generally

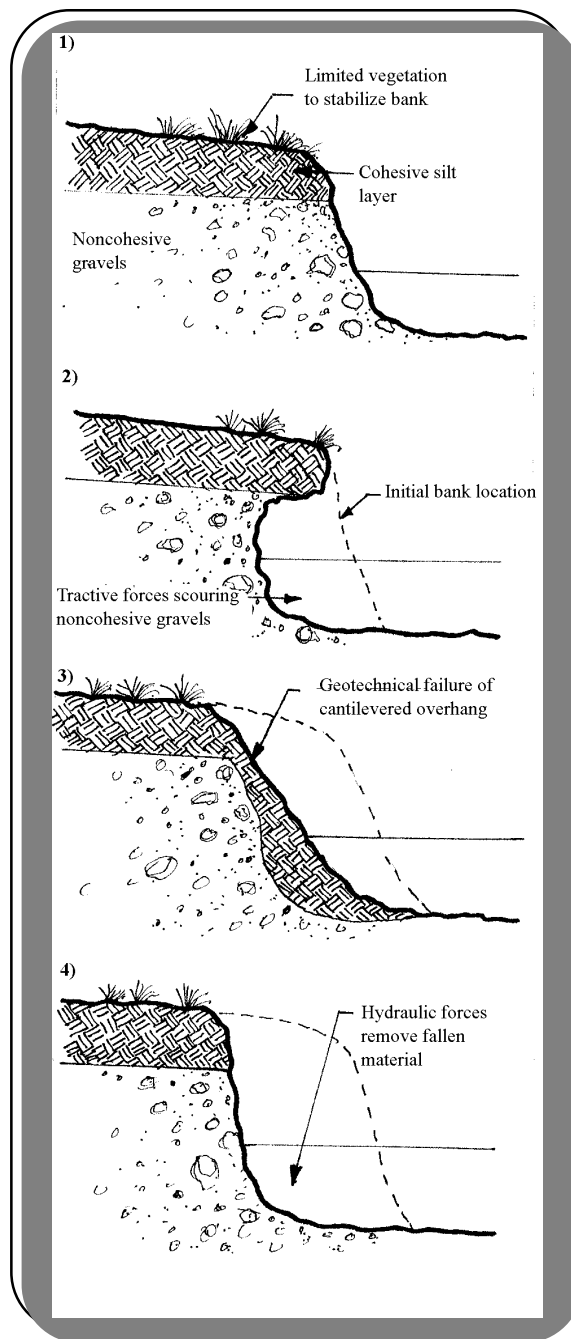


Fig. 3.5 *Stratified Streambanks and Combination Failures*
(Adapted from Johnson and Stypula 1993)



protect any cohesionless layers above (although these layers will still be subject to surface erosion).

Streambank Failure Mechanisms

Bank failures in fluvial systems generally occur in one of three ways (Fischenich 1989): hydraulic forces remove erodible bed or bank material, geotechnical instabilities result in bank failures, or a combination of hydraulic and geotechnical forces cause failure. Fischenich (1989: pp 103) describes each failure mechanism and its characteristics as follows:

Hydraulic Failures. Bank erosion occurs when flowing water exerts a tractive force that exceeds the critical shear stress for that particular streambank material. Hydraulic failure is generally characterized by a lack of vegetation, high boundary velocities, and no mass soil wasting at the toe of the slope.

Geotechnical Failures. Geotechnical failures that are unrelated to hydraulic failures are usually a result of bank moisture problems. Moisture can affect the ability of the bank material to withstand stresses. Failures are often the result of the shear strength of the

bank material being exceeded. Characteristics of geotechnical failures can vary, although mass wasting of soil at the toe of the bank is often one indicator.

Combination. The most common failure is due to a combination of hydraulic and geotechnical forces (refer to Fig. 3.5). For example, bed degradation due to hydraulic forces can lead to an oversteepening of the banks which can result in a geotechnical failure of mass wasting.

Cause of Failures

Although bank failures result from three different mechanisms, the actual causes of erosion are complex and varied (Fischenich 1989). Successful bioengineering projects need to address the causes of failure.

Erosion from hydraulic forces is usually connected to flow velocities and/or its direction (Fischenich 1989). Human actions are often responsible. Channelization and constrictions caused by bridges are examples that will change velocities. Changes in flow direction often result from an obstruction along or in the channel. Any unnatural destruction of bank vegetation promotes erosion by hydraulic forces.

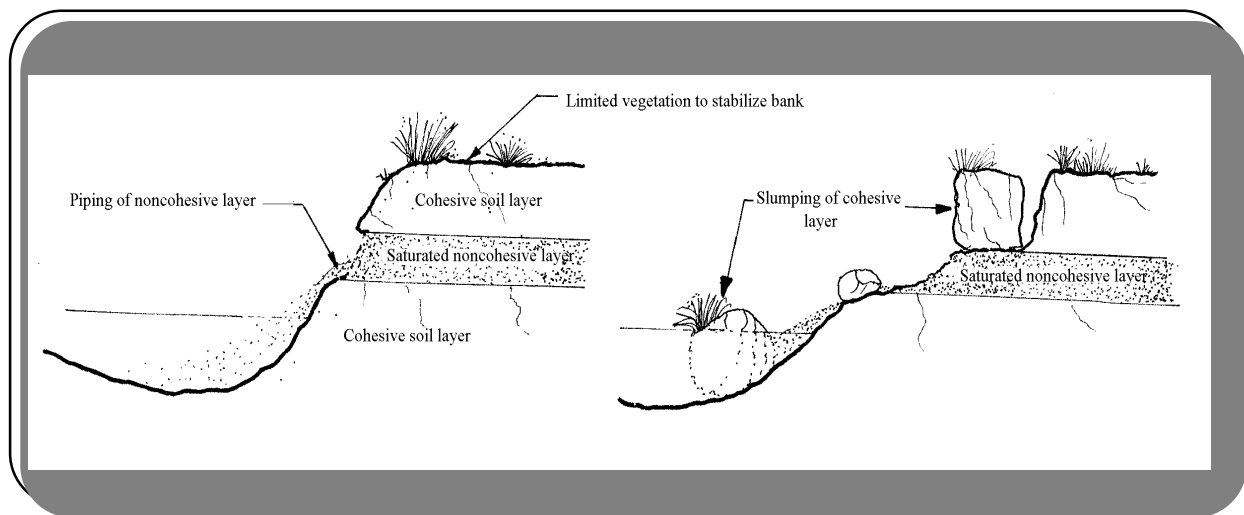


Fig. 3.6 Bank Erosion Due to Piping
(Adapted from Hagerty 1991).



Geotechnical failures are usually the result of moisture conditions in the streambank which create forces that exceed bank resistance. Common examples of the causes include (Hagerty 1991; USACE 1981):

- * Banks are destabilized by the piping of cohesionless soil from lenses (Fig. 3.6).
- * Capillary action temporarily decreases the angle of repose of the bank material to less than the existing bank slope.
- * Liquefaction of fine-grained material causes fluid-like failures of the bank from pore pressure increase during rapid drawdown.
- * Shrinking and swelling of clay soils during wetting and drying cycles causes tension cracks.
- * Freezing and thawing of soil which weakens the shear strength.
- * Subsurface moisture changes weaken the internal shear strength of the soil mass at the interface of different soil types.

Since the most common mode of failure is a combination of hydraulic and geotechnical forces, an interdisciplinary team is crucial in identifying the causes of failure. Some of the steps to assist in determining streambank failure mechanisms and causes include the following:

1. Determine streambank composition and stratification. Assess possible streambank failure mechanisms by observing the site over a period of time.
2. Several cross sections should be taken to graphically show the channel in relation to the floodplain. This information will help reveal the type of degradation (i.e., lateral erosion or downcutting) and will provide baseline data for

future monitoring. If a channel is actively downcutting, these sites are significantly more difficult to stabilize and should generally be avoided unless instream structural measures are planned. If the streambank is cutting laterally, appropriate bioengineering methods may be more successful.

3. A survey should be completed of the longitudinal profile of the channel thalweg (the deepest point along a stream). This will illustrate any unusual characteristics of the stream slope which might indicate areas that may be more unstable.

4. Type of bed material and distribution should be determined. This will provide clues to the resistance of the material to erosive flows. Particle size distributions can be calculated by collecting and screening samples, or for the surface layer only, a pebble count of exposed particles can be sampled (Leopold 1994).

STEP 5 DESIGN PROCESS

The next step is to design a site specific

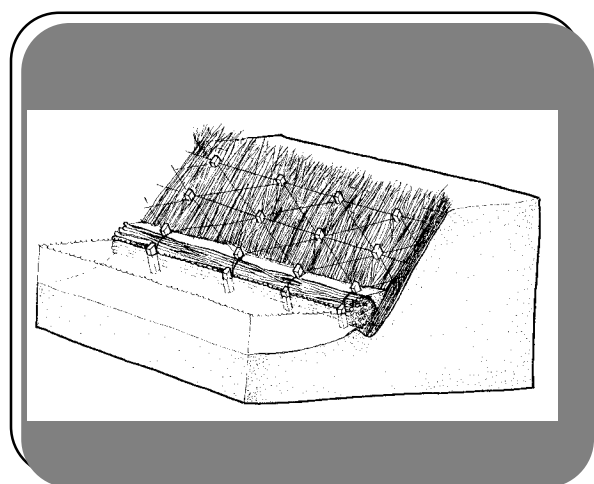


Fig. 3.7 *Willow Brush Mattress Technique*



bioengineering project. Appendix A covers a selection of bioengineering techniques (Fig. 3.7). Many of these techniques should be combined with others to provide a method that will be most suitable for the project.

DESIGN GUIDELINES

The following are some important factors to consider during the design process. This discussion of factors is not complete but rather a starting point for a collaborative process between members of the design team.

Hydrology

Hydrology is one of the most important factors to consider in a bioengineering design. It is common for streams to have widely fluctuating flows from spring runoff to late summer flows. Bioengineering in the Great Basin and Intermountain region is a balancing act. In addition to providing protection during high flows, the vegetation must also have access to the late summer water table in order to survive.

Groundwater well data can provide insight on the fluctuations of the water table. Calculating the magnitude of discharge (Q) for different flow events can also provide valuable information. Discharge is based on:

$$Q = V * A$$

where Q = discharge (ft³/sec)
 V = velocity (ft/sec)
 A = cross-sectional area (ft²)

while velocity is based on Manning's equation:

$$V = 1.49 * \frac{R^{2/3} * S^{1/2}}{n}$$

where R = hydraulic radius (ft²/ft)
 S = slope (ft/ft)
 n = coefficient of roughness

(Dunne and Leopold 1978)

Using these equations, a hydrologist can construct a characterization of the hydrological parameters at the site. For example, different theoretical flood events can be used with cross-sectional data to estimate the water elevations at the proposed restoration site. Duration of flooding can also be estimated to determine if the plant species selected can handle the period of inundation.

In particular, bankfull discharge (Q_{1.5}), which typically has a recurrence interval of approximately 1.5 years, is an important benchmark because it is a dominant channel shaping flow (Leopold 1994). It is also crucial because it will provide some guidance for locating vegetation that may receive moisture from this frequent flooding activity.

Streamflow Velocity

Very little research is available on the relationship of the stability of woody streambank vegetation to flow velocity (Carlson et al. 1995). Parsons (1963) evaluated streambank willow plantings in the northeastern United States and equated a fully developed stand of densely stemmed purple-osier willow (*S. purpurea*) to a blanket of 6-inch angular rip-rap. Other research has focused primarily on grassed waterways and may not be directly transferable to the region's cobble bed streams (Temple et al. 1987).

Instead, tractive force guidelines provided in the following section may be a better indicator of stability. In high velocity situations, a combination of bioengineering techniques and hard structures may be necessary. Hard structures will significantly reduce erosion in a



much shorter period of time than bioengineering structures, however, by incorporating bioengineering into the plans, a much better design will be obtained.

Hydraulic Considerations

Tractive Forces

One of the most important hydraulic design criteria for bioengineering projects is the erosive forces on the bed and banks usually referred to as tractive force or shear stress (Miller 1996). The average tractive force on a bank is equal to:

$$T = \gamma dS$$

where γ = unit weight of water; 62.4 lb./ft²
 d = depth of flow for a particular discharge event in feet (ft); and
 S = channel gradient in ft/ft

(Chen and Cotton 1988)

Schiechtel and Stern (1994) offer some guidelines for maximum tractive forces in lbs/ft² for structures immediately after completion and after 3 to 4 years of root development (Table 3.2). Again, it should be remembered that some bank erosion is part of the natural process.

Table 3.2 Maximum tractive forces for bioengineering

Technique	Force (lbs/ft ²)	
	immediately after completion	after 3-4 seasons
Reed plantings (herbaceous)	10	70
Deciduous trees plantings	50	290
Willow Wattle	145	190
Brush Layer	50	340
Brush Mattress	120	725
Rip-rap with live cuttings	480	725

Adapted from Schiechtel and Stern (1994).

Depth of Scour

Another important design criteria is depth of scour. During high flow events, bed materials become mobile (Leopold 1994). For a given discharge, there is an average depth at which the bed will begin to move, referred to as the depth of scour. Excessive scour can undermine the bioengineering treatment and cause failure. The estimated scour depth can be used to identify the depth at which toe stabilization will need to be placed in order to remain stable during a particular discharge event (Miller 1996). There are different equations that can be used to estimate the depth of scour (Chang 1992).

Endpoint Protection

Another area that is subject to failure in a bioengineering project is the upstream and downstream ends of the installation. These endpoints must be protected so that the streamflow does not get behind the structure. If flows do get behind the structure, soil can be scoured out, stakes and wire can be dislodged, and the integrity of the structure can be weakened or destroyed. Sometimes the endpoints can be keyed into existing features such as boulders, large trees, etc. (Fig. 3.8). In other cases, the endpoints will need to be

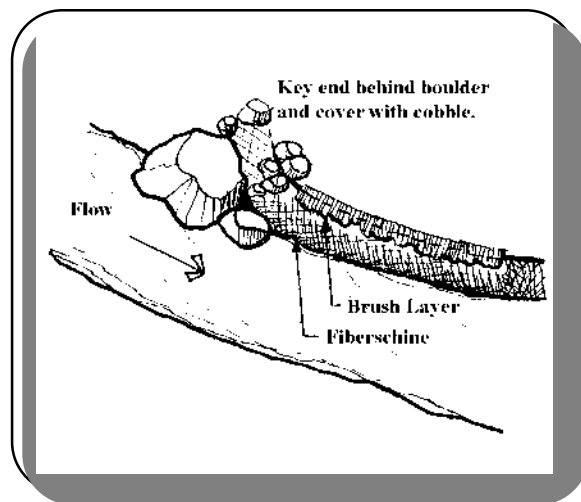


Fig. 3.8 Endpoint Protection



protected by keying in the treatment ends using rock and other types of revetment. Remember to always start and extend the treatment beyond the obvious eroded areas.

Fluvial Geomorphology

Fluvial geomorphic parameters should be used in the design phase of the bioengineering project to assess how the treatment might affect the stream channel and flows. For example, it is important that the appropriate channel width, depth, and hydraulic radius are maintained to carry the bankfull discharge (Miller 1996; Dunne and Leopold 1978).

One tool that may be used to gain an understanding of fluvial geomorphology, at least in the West, is the Rosgen Stream Classification System (Rosgen 1994). It should be noted that the system is based on natural streams and may not be easily transferable to a degraded system.

This system should not be used as a recipe book for determining restoration techniques and specific channel geometry. Each project should be approached as a unique situation (Kondolf 1996). Beschta and Platts (1986) note that channel morphology is related to a large number of interacting variables such that the "expected" width or depth of a particular stream reach cannot be calculated or predicted. However, with caution, the Rosgen classification system may provide some guidance for width, depth, and sinuosity of similar natural streams.

Geotechnical Considerations

As Fischenich (1989) stated, erosional problems along streams often result from a combination of hydraulic and geotechnical mechanisms. The detailed inventory should reveal all geotechnical failures occurring at the

project site. Once these factors are identified, the design should incorporate measures to address these problems. In general, most geotechnical deficiencies require an increase in soil shear strength (Fischenich 1989). This is usually accomplished with roots in the vegetative component of the bioengineering project (Gray and Leiser 1982). In addition to the tensile strength provided by the roots, they will also moderate saturated soil conditions and minimize effects of piping and liquefaction (Gray and Leiser 1982).

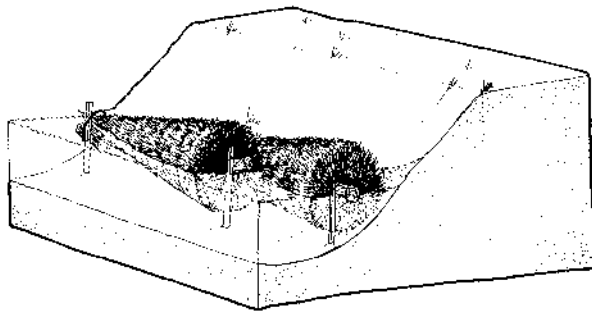
In some cases, supplementary drainage measures may be required when rapid drawdown of flood waters causes streambanks to fail due to increased soil water pressure (Miller 1996). Methods allowing internal drainage may be necessary such as sloped gravel drains and weep pipes (Miller 1996; Fischenich 1989).

Another geotechnical design consideration is determining a stable angle of repose or slope. Different theoretical analyses can be used to estimate a suitable angle of repose (Gray and Leiser 1982). Existing, stable slopes in the area can be used as a benchmark for design purposes. Be sure to select slopes that occupy similar channel positions compared to the treatment area; i.e. a concave bend may have a steeper slope than other areas. It should be pointed out that a natural stabilized slope can occur at a steeper angle than a newly vegetated slope unless additional protection measures such as erosion control fabric are incorporated in the design.

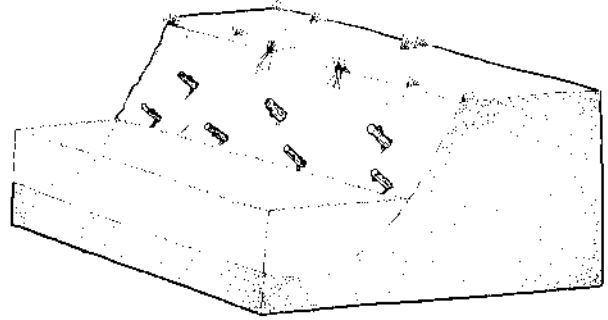
Putting It All Together

The following pages illustrate the different techniques found in Appendix A (Fig. 3.9a-b). Each treatment is described in separate technique sheets to clarify and highlight that specific technique. During the design process, these various techniques will usually be combined into one treatment that will address the problems identified during the inventory

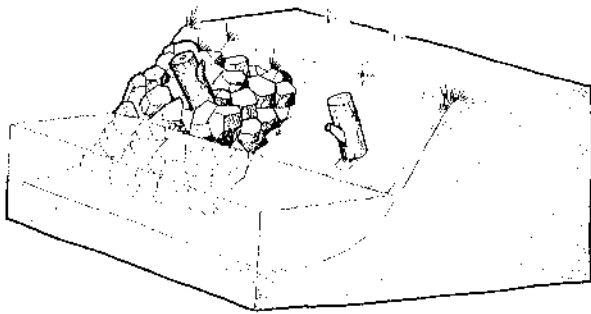




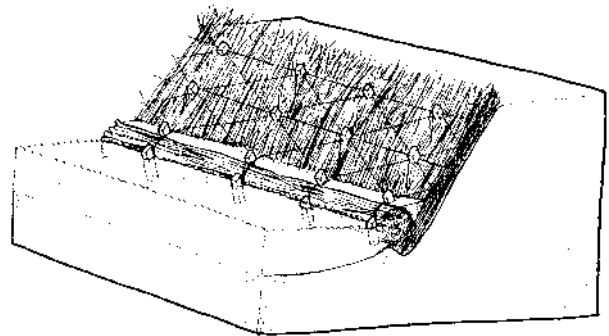
Brush Revetment



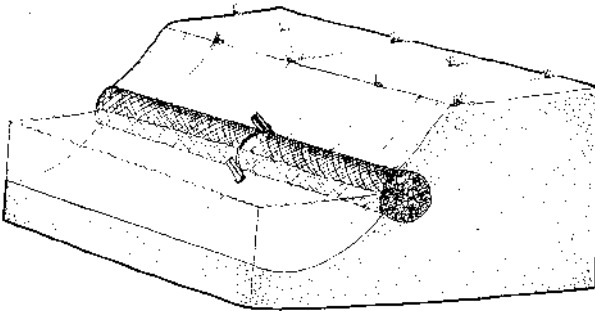
Pole Plantings



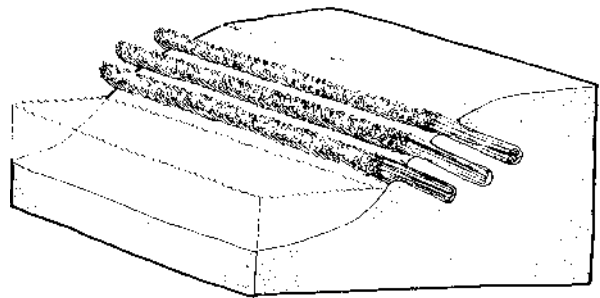
Post Plantings



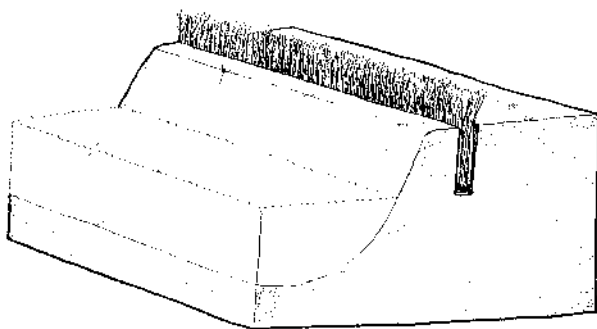
Brush Mattress



Fiberschines

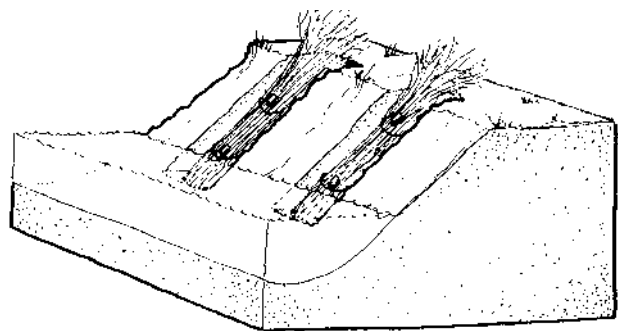


Brush Layer



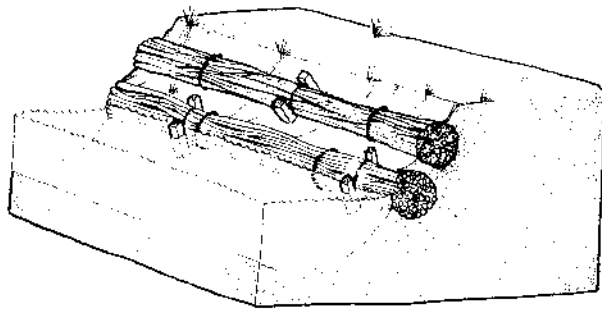
Brush Trench

Fig. 3.9a

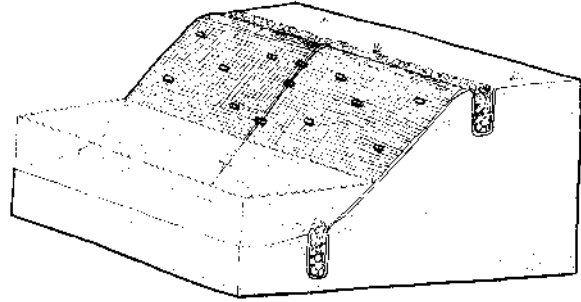


Vertical Bundles





Willow Wattles



Erosion Control Fabric

Fig. 3.9b

and analysis phase. These technique sheets may be photocopied individually and handed out to landowners contemplating bioengineering work on their property. Additional technique sheets may be added in the future.

Many other bioengineering techniques are applicable for riparian areas. Some resources include Allen and Leech (1997), Schiechl and Stern (1994) and Gray and Leiser (1982).

Fig. 3.10 demonstrates a theoretical application of the use of a combination of techniques. Although this is a simplified example, it illustrates how the different hydrologic, hydraulic, geotechnical, and vegetation considerations can be addressed.

STEP 6 PERMIT PROCESS

After a conceptual design has been completed, it is important to check with the Army Corps of Engineers, the state agency in charge of regulatory stream permits, and any local agencies that might have jurisdiction to determine the necessary permits. In some cases, it may be worthwhile to bring the regulatory agencies on site so they can fully understand the project's objectives and design.

If the proposed project requires the placement of fill material in any waters of the United States, it will be necessary to obtain a Section 404 Permit from the U.S. Army Corps of Engineers. Most stream work falls under the Nationwide permitting (NWP) process which includes over 30 types of NWP. The most commonly used NWP for stream stabilization projects is the NWP 13-Bank Stabilization.

NWP 13 allows bank stabilization measures for erosion prevention based on the following analysis:

- * amount of material placed in the waters of the U.S.;
- * length of the bank stabilization project;
- * will material be placed in any special aquatic site;
- * is the activity part of a single and complete project.

In some instances, a Letter of Permission may be all that is required to install a bioengineering project if fill is not being added to the stream channel. However, the regulatory agencies should **always** be contacted in order to prevent any surprises.



STEP 7 IMPLEMENTATION

Timing of bioengineering projects is critical. The most optimum time to install projects is usually in the spring. Periods of high flows should be avoided for safety reasons. Spring time projects allow the use of dormant cuttings which have the highest success rate. Implementation should also take into consideration wildlife and fisheries concerns. Critical spawning periods should be avoided.

Scheduling the sequence of work is also important. Dormant cuttings should be soaked for 5-7 days (see Chapter Four). Thus, harvesting and soaking of cuttings needs to be scheduled and completed a few days before construction. If the project incorporates nonliving material, such as brush revetment, it may be installed while the cuttings are soaking. Non-living components such as brush revetment may be constructed the season before the installation of the plantings.

Projects should always avoid or minimize impacts to wetlands and other sensitive areas.

Never disturb the site unnecessarily. Remember the goal is to stabilize a site. The less it is disturbed, the easier it will be to restore.

STEP 8 MAINTENANCE AND MONITORING.

Maintenance and monitoring are probably the most important things that you can do to ensure the success of a bioengineering project. Many times, planned maintenance can make the difference between success and failure. Monitoring will help you to determine what has worked and what hasn't. Remember that bioengineering is not exact science, but rather it is an art that must be designed from many different factors that are not always easy to determine. Some of the techniques will work well in one situation, but not in others. The secret is to learn over time and many different projects.

Maintenance and monitoring will be covered in detail in Chapter Five.

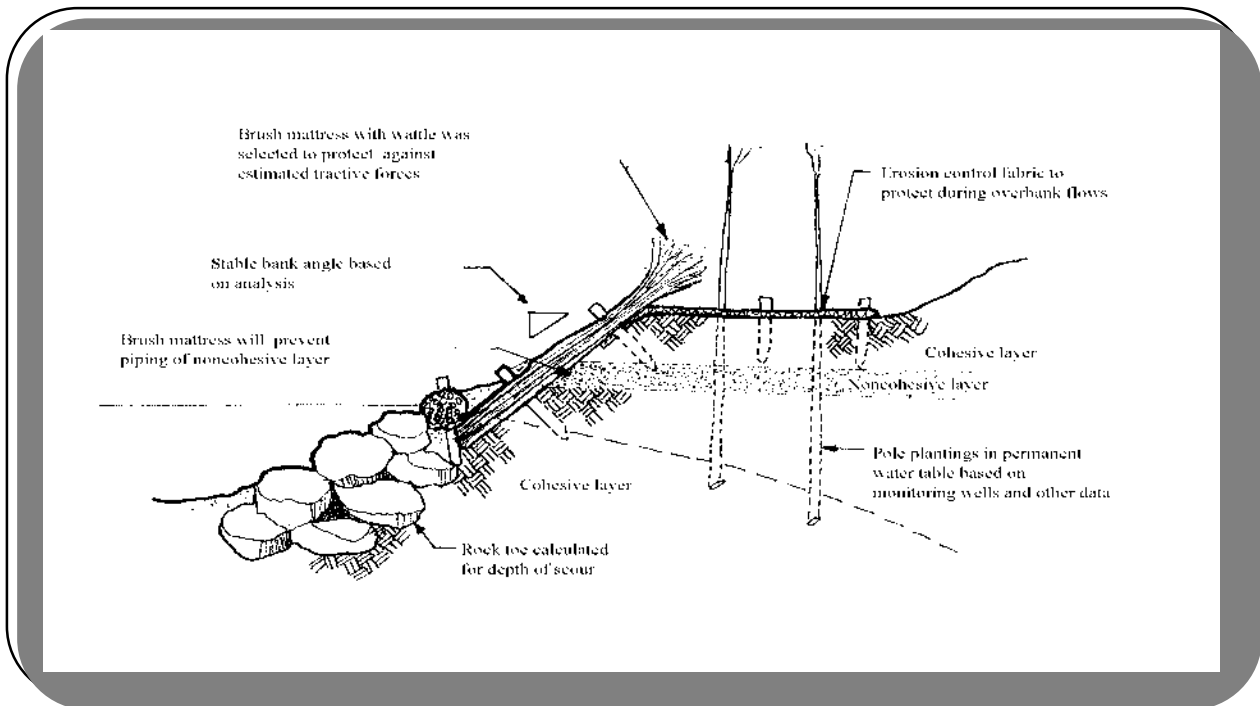


Fig. 3.10 Theoretical Example of Combining Techniques





Narrowleaf Cottonwood
Populus angustifolia

Chapter Four
Vegetation Selection
and
Procurement



Vegetation Selection and Procurement

SPECIES SELECTION

Establishment of riparian plant species depends on proper selection of species, plant material procurement and handling, planting location, and establishment techniques (Hoag 1993a). The success of a bioengineering project is dependent on the holistic integration of these steps.

A vegetation inventory of the area will indicate suitable species for the project. In the inventory process, healthy, native stands should be located as possible harvest locations for cuttings. In degraded areas, one may need to look upstream or downstream for a healthy representative plant community. One should realize, however, that conditions at the representative plant community may vary from the project site. In these cases, a person knowledgeable in riparian vegetation will be extremely helpful. Regional classification systems of riparian and wetland sites can also be consulted, such as, *Classification and Management of Montana's Riparian and Wetland Sites* (Hansen et al. 1995) and *Riparian Community Type Classification of Utah and Southeastern Idaho* (Padgett et al. 1989).

Different species have characteristics that may make them more suitable for a particular bioengineering project. For example, willows with a deep, spreading root system may stabilize a bank better than species with a shallow root system. Tree species may be appropriate in some cases when shade is a desired goal. However, they need to be planted out of the bankfull discharge area because they will not survive the frequent, high flows that occur in this zone.

Bioengineering methods should rely on both

woody and herbaceous plant materials. Look for wetland areas with herbaceous plants that can survive in flowing water. Wetland plants like bulrush (*Scirpus* spp.) and cattail (*Typha* spp.) can act as a buffer to reduce the velocity of streamflows that intercept the bank. It is important to remember that anything to reduce the streamflow velocity before it intercepts the bank will help to ensure a successful bioengineering project.

Plant Species Information Table

Table 4-1 (on pp. 40-43) provides information on some woody riparian species found in the Great Basin and Intermountain Region. As the table shows, willow, cottonwood, and dogwood species are the most appropriate plants to propagate from hardwood cuttings. Other riparian plants such as alder and birch do not sprout from hardwood cuttings and should be obtained as potted plants from a nursery.

Table 4-2 (on pp. 44-45) provides information on wetland herbaceous species found in the region and that may be appropriate for bioengineering projects.

The table is based on published information as well as current, personal experience of the authors and others. Some differences may be noted in your particular area and application.

PLANT MATERIAL PROCUREMENT AND HANDLING

Woody plant materials for bioengineering are typically bare-root stock or dormant unrooted hardwood cuttings. The main benefits of using hardwood cuttings are; lower cost, ease of planting, depth of planting, local ecotype, and availability.

Hardwood cuttings can be divided into three



general categories: pole, post, and bundled cuttings. Pole cuttings can be from shrub and tree species and usually range in diameter from 1/2 to 3 inches. Post plantings are from tree species and range in diameter from 3 to 6 inches (Hoag 1993b). In general, larger diameter cuttings have more stored energy than smaller diameters and thus have a higher potential survival rate. Bundled cuttings are small diameter cuttings (no smaller than 3/8 inch) from different species with the branches left on that are used in techniques, such as wattles, brush layering, brush mattress, and vertical bundles.

Timing

Cuttings can be collected any time during the dormant season, from leaf fall to just before the buds begin to break in spring. Cuttings can also be collected during the growing season if all the leaves are removed from the stem prior to planting, although establishment success will be lower (Hoag 1993b).

Planting should be geared for periods during which the plants will have adequate moisture for establishment and yet will not be subject to high flow events. In this region, installation usually occurs after spring run-off. Occasionally, a high run-off year may push the planting window into early summer. Summer plantings should generally be avoided because of hot temperatures and dry conditions. It may be desirable to delay installation until fall. Fall plantings, however, are susceptible to frost heave and ice flows which may rip out roots that are not yet established. Even when planting occurs at a proper time, a flash flood event may damage the cuttings before they have had enough time to root in the streambank. Consequently, maintenance of the project is critical during the first 2 to 3 seasons.

Harvest of Cuttings

Cuttings should be thinned from healthy, native stands. Collect cuttings from live wood that is

at least two years old. Avoid cuttings from old stems that are heavily furrowed, or infested with insect or disease, and young sucker growth. Thinning can be done with loppers, chainsaws, or brush cutters. Make sure the equipment is sharp enough to make clean cuts. In general, one should avoid thinning more than 2/3 of the total individual plant to avoid harming it (Fig. 4.1). In the case of a high water event, the remaining 1/3 of the plant may still be above water, and therefore, able to supply oxygen to the root system (Hoag 1993b). This also ensures that some habitat for songbirds and other wildlife remains while the other cuttings are becoming established.

Try removing cuttings from inside the crown area, and spread the harvesting activity throughout the stand to minimize visual impact. Always obtain permission from landowners before harvesting.

Trim off all side branches and the terminal bud (the bud at the growing tip) so energy will be rerouted to the lateral buds for more efficient root and stem sprouting. Cuttings can be tied

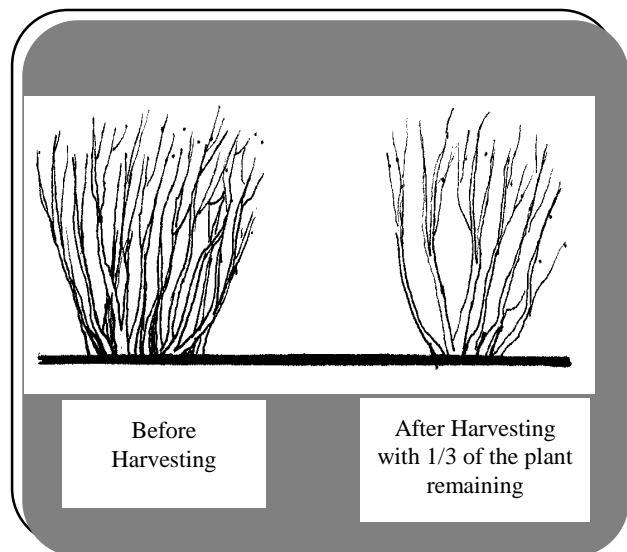


Fig. 4.1 *Collecting Cuttings*



into bundles to facilitate transporting and soaking.

Cutting length is dependent on the application. Cuttings should be long enough to extend 6-8 inches into the permanent water table or capillary fringe. At least one-half to two-thirds of the cutting should be below ground to prevent it from being ripped out during high flows. The cutting should be long enough to extend above the competing herbaceous vegetation and should extend down beneath the competing plant root mass. Be careful not to extend the top of the cutting too high if planted in the channel below the bankfull zone, because the cutting may be susceptible to major damage from debris and ice flows during runoff (Hoag 1993b).

If cuttings are collected well in advance of project construction, they must be stored in a cool (34-36° F) humid, dark place until ready to plant (i.e., root cellar or cooler). Cuttings can usually be stored for up to 6 months without significant reduction in rooting establishment and success.

Prior to planting, soak the cuttings in water for 5 to 7 days (minimum 24 hours). Soaking swells the root primordia and may leach out natural anti-rooting hormones found in the cuttings. Remove the cuttings from water before root tips emerge. When the cuttings are removed from the water, they should be immediately taken to the project site and planted (Hoag 1993b).

Other Forms of Plant Materials

Other forms of plant materials include container stock, bare root plants, transplant plugs, rhizomes, clumps, and seeds. Where appropriate, several different forms of plant materials can be planted to increase the chances for a successful project.

Nursery Stock

Container stock and bareroot material are generally acquired from a nursery. Nursery stock usually has good root development, energy reserves, and few pests. The main disadvantage is cost. Bioengineering techniques often rely on density of brush (i.e., brush trench) which would be difficult and costly to achieve with nursery stock. Nursery stock is best reserved for species that can not be propagated from cuttings.

Another thing to keep in mind is genetic variability within species. Plants of the same species have ecotypes that are best suited to a particular region. Some suggest that ecotypes generally do not range more than 100 to 200 miles of latitude from a particular site. However, this varies considerably based on the plant's breeding system. Consequently, one should find out where the nursery stock is originally from and determine if this meets the project's goals.

Transplant Plugs

Transplanting plugs of wetland herbaceous plants is often a viable method for incorporating these species in a project. Plugs should be 3 to 12 inches in diameter and 5 to 6 inches deep. They can be collected with a shovel or with a coring device made from an appropriate diameter of PVC pipe.

Generally, one can harvest about 1 square foot in a 10 foot square area without harming the plant community (Hoag and Sellers 1995). When collecting plugs, avoid areas that have noxious weeds such as purple loosestrife

Key to Planting in the West

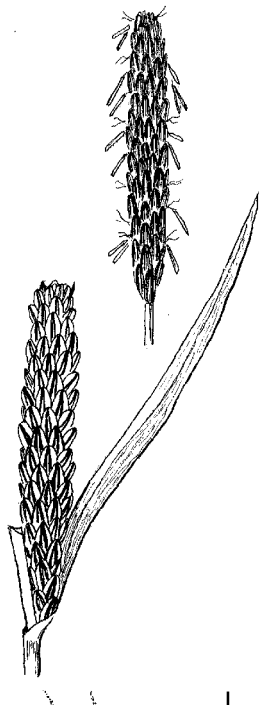
1. *Hydrology*
2. *Hydrology*
3. *Hydrology*



(*Lythrum salicaria*). Incorporation of seeds of unwanted species can be a significant drawback to the use of this method. Observation of proposed collection sites over a growing season can help to identify potential problems.

When collecting and transporting plugs, it is very important to keep the plants moist and cool. Styrofoam coolers filled with enough water to cover the roots are effective containers for transporting plugs. They can also be floated in the stream while planting at the project site (Hoag and Sellers 1995). Plugs can be planted whole or subdivided into 3 to 4 individual plugs.

Plugs can be transplanted during most of the growing season with good success. Transplanting in late summer should be avoided due to heat stress and limited time for establishment before the first frost. Tops of the plants should be cut off to reduce transplanting



Water Sedge
Carex aquatilis

shock. Leave enough of top exposed so that it will stick up out of the water and allow oxygen to get to the roots.

Rhizomes

Rhizomes are the underground horizontal stems produced by some herbaceous plants such as cattails (*Typha* spp.) and bulrushes (*Scirpus* spp.) Rhizomes can be dug and divided into sections, taking care to keep at least one viable growth point or node on each section. Care must be taken to ensure that material being collected is young and healthy, generally indicated by firmness of the material.

These materials can be collected early in the spring before plants break dormancy or at the end of the growing season when the energy stored in the material is at its' greatest. The material can be planted at this time or stored in sand or peat. They should be kept at a cool temperature (40° F) until planting time (Marburger 1992). The growth node should be sticking up when planting these materials.

Clump Plantings

Clumps are large plugs that have a good functioning root system in addition to extensive above-ground biomass. Clumps are taken from existing stands, usually with a backhoe. Care should be taken so the backhoe operator does not dig too deeply. Usually 12 to 15 inches is enough to get most of the root mass. Minimal damage will occur if clumps are taken randomly from native stands.

Usually after one or two growing seasons; water, sediment, and remaining roots will fill in the holes. At higher elevations, where the growing season is short, this technique should be used with additional caution since it will take longer for the collection sites to revegetate. Holes should be backfilled and seeded if the growing season is short.

This is an extremely efficient technique that does



not require the plants to root or develop above-ground material to be effective.

Seeds

Seeds can be used to increase the diversity of the site. Seeding in disturbed soil will decrease weed invasion that typically occurs on exposed soil. Seeded areas can take longer than transplants to establish, so they should not be considered as an erosion control planting. Over the long term, however, seeding can provide additional root masses and above-ground biomass that will help reduce streamflow energy and promote sediment deposition. The Resource Section suggests possible references for determining an appropriate seeding mix and how to sow it.

PLANTING LOCATION

Observe the existing types of plants and their respective locations in relationship to the stream and water table (Fig. 4.2). This is the biological benchmark one is striving to create. Plants with flexible stems and rhizomatous root systems are usually located from the water-line to mid-bank zone. Larger shrubs are found from mid-bank zone to the top of the overbank zone. Tree species are usually found above the overbank zone in the floodplain. Wetland herbaceous species can be found throughout the streambank cross section, although most emergent aquatics will be found in the toe zone.

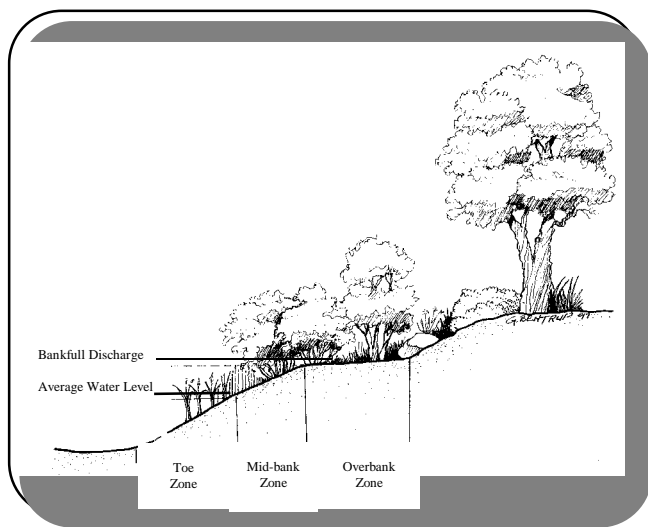


Fig. 4.2 Planting Zones

zone to the top of the overbank zone. Tree species are usually found above the overbank zone in the floodplain. Wetland herbaceous species can be found throughout the streambank cross section, although most emergent aquatics will be found in the toe zone.

ESTABLISHMENT TECHNIQUES

Pole plantings are normally planted with planting bars, soil augers, and power augers. Post plantings are planted with post-hole diggers, tractor mounted posthole augers and a backhoe-mounted bar called "The Stinger" (see Post Planting Technique Sheet). Bundled cuttings are planted according to the specific

General Establishment Factors for Woody Cuttings

1. Cuttings must reach the permanent water table or capillary fringe.
2. Minimize major damage to the buds when inserting a cutting in the hole. Avoid separating the bark from the cambium layer.
3. Make sure there are no air pockets around the cutting. Backfill with a soil and water slurry to remove air pockets.
4. Experiment with planting methods to determine a suitable method for your site conditions.

Note: Fertilizers and rooting hormone rarely improve success of high volume plantings enough to offset the cost and the extra labor involved.



technique. Water tables will often determine the planting method and planting depth.

Whatever the planting method, general establishment factors are important and should be considered.

MANAGEMENT

Determine the land management that is in place at the project site. If management changes are needed, make sure you get commitment from the landowner before you begin planting. If landowner does not agree to needed changes, the chances of implementing and maintaining a successful bioengineering project are unlikely.

If the site is grazed, temporary fences must be installed before planting to ensure that no grazing takes place for the first 2 to 4 years after planting. Grazing after that period may be allowed only after careful examination of the site and plantings. The buffer strip edge should be grazed only under controlled conditions. Use willows and other woody species along the water's edge as the key species to monitor when setting up a grazing management plan.

Wildlife Issues

Beaver, muskrats, ducks, geese, deer, elk, and other wildlife can do tremendous damage to new plantings. As part of the inventory process, one should identify if the site is in a deer or elk wintering range, if beaver or

muskrat are active in the area, and if geese are commonly found on the site. If these wildlife are present on or near the site, bioengineering projects can still be installed, but the establishment period will be longer and the chances of success may be lowered.

Generally, measures that are used to protect the planting will probably only be necessary for the first couple of years (your inventory should give a better idea of the length of time necessary). This allows enough time for good root growth. If the woody plants are browsed after they have been established for a year, they will generally resprout from the base.

Geese and other waterfowl can be kept from the plantings, especially the herbaceous components, by using temporary fencing such as electric fencing without the power. The area that needs to be protected can be fenced as a very narrow strip. Geese will not go into the fenced area as they avoid confining areas (Hoag 1993a). This fencing can be removed after 1 to 2 years.

Beaver and muskrat are the most difficult wildlife to manage in a bioengineering project. Various methods have been tried with various degrees of success. These methods include;



Booth's Willow
Salix boothii

*"Come forth
into the light of things.
Let Nature be your teacher."*

William Wordsworth



Table 4-1a Woody Species for Bioengineering in the Great Basin and Intermountain West

Species	Size/Form	Elevation Range ¹	Root Type	Rooting Ability from cuttings	Availability In Field ²
<i>Acer negundo</i> Boxelder	Med. Tree	Low - Mid.	Moderately Spreading	Poor	Common
<i>Alnus rubra</i> Red alder	Med. Tree	Mid. - High	Shallow Spreading	Poor	Fairly Common
<i>Alnus sinuata</i> Sitka alder	Sm.-Med. Tree	Mid. - High	Shallow Spreading	Poor	Fairly Common
<i>Alnus incana</i> spp. <i>tenuifolia</i> Thinleaf alder	Sm.-Med. Tree	Mid. - High	Shallow Spreading	Poor	Common
<i>Betula occidentalis</i> Water birch	Lg. Shrub to Sm. Tree	Mid. - High	Shallow to Deep Spreading	Poor	Fairly Common
<i>Cornus sericea</i> Redosier dogwood	Med. Shrub	Mid.	Shallow	Moderate-need to nick & use hormone	Fairly Common
<i>Crataegus douglasii</i> Black hawthorn	Sm. Tree	Low - Mid.	Shallow to Deep Spreading	Poor	Fairly Common
<i>Pentaphylloides floribunda</i> Shrubby cinquefoil	Sm. Shrub	Low - Mid.	Shallow to Deep Spreading	Poor	Very Common
<i>Philadelphus lewisii</i> Mockorange	Sm. - Med. Shrub	Low-Mid.	Spreading Fibrous	Poor	Common
<i>Populus angustifolia</i> Narrowleaf cottonwood	Lg. Tree	Mid.	Shallow	Very Good	Very Common
<i>Populus fremontii</i> Fremont cottonwood	Lg. Tree	Low - Mid.	Shallow Fibrous	Very Good	Fairly Common
<i>Populus tremuloides</i> Quaking aspen	Med. Tree	Mid. - High	Shallow	Poor	Very Common
<i>Populus trichocarpa</i> Black cottonwood	Lg. Tree	Low - Mid.	Shallow Fibrous	Very Good	Very Common
<i>Prunus virginiana</i> Chokecherry	Med. - Lg. Shrub	Low - Mid.	Rhizomatous	Good from root cuttings	Common
<i>Rhus trilobata</i> Skunkbush sumac	Med. - Lg. Shrub	Low - Mid.	Deep Spreading Rhizomatous	Poor	Fairly Common
<i>Ribes aureum</i> Golden current	Sm. - Med. Shrub	Low - Mid.	Spreading	Good (in greenhouse)	Common
<i>Rosa woodsii</i> Wood's rose	Sm. - Med. Shrub	Low - Mid.	Shallow to Deep	Good (in greenhouse)	Very Common
<i>Salix amygdaloides</i> Peachleaf willow	Sm. Tree	Low	Fibrous	Very Good	Common
<i>Salix bebbiana</i> Bebb's willow	Lg. Shrub	Low to Mid.	Shallow to Deep	Good	Common

Footnotes:

U = Unknown

- Elevation Range:** data for this region.
 Low 2,000-4,500 feet
 Middle 4,500-7,000 feet
 High 7,000-10,000 feet
- Availability in the Field:** This refers to its natural occurrence in the region. This is particularly important for species that may be harvested for hardwood cuttings. The order of the ranking is from least to greatest: Fairly Common, Common, and Very Common.

- Commercial Availability:** This refers to whether or not it is currently available in the nursery trade. Refer to the Resource section for information on a nursery guide.
- Tolerance to Deposition:** Regrowth from shallow coverage by soil.
- Tolerance to Flooding:**
 High Damage after 10 to 30 days of flooding
 Medium Damage after 6 to 10 days of flooding
 Low Damage after 1 to 5 days of flooding
- Tolerance to Drought:** Resistance to drought relative to native vegetation on similar sites.
- Tolerance to Salinity:** Resistance to salinity relative to



Commerical Availability ³	Deposition Tolerance ⁴	Flooding Tolerance ⁵	Drought Tolerance ⁶	Salinity Tolerance ⁷	Wildlife Value/Misc. Notes
Yes	High	High	High	Med.	
Yes	Med.	Med.	Low	Low	Big game browse upland bird food
Yes	Med.	Med.	Low	Low	Big game browse upland bird food
Yes	Med.	Med.	Low	Low	Big game browse upland bird food
Yes	Med.	Med	Low	Low	Big game browse
Yes	Low	High	Med.	Low	Big game browse, small mammal food upland bird food.
Yes	Med.	Low	High	Low	Browse for many species and cover
Yes	U	U	High	U	Big game browse
Yes	U	U	U	U	Big game browse
Yes	Med.	Med.	High	Med.	Big game browse
Yes	Med.	Med.	Med.	Med.	Big game browse
Yes	Low	Low	Med.	Med.	Big game browse
Yes	Med.	Med.	Med.	U	Big game browse
Yes	Low	Low	Low-Med.	Low-Med	Birds and small mammals eat fruits
Yes	High	Med.-High	Med.-High	Med.	Birds and small mammals eat fruits Can not tolerate long-term flooding
Yes	U	U	U	U	Birds and sma. mammals eat fruits
Yes	U	Low	Low-High	Low	Rosehips eaten by many species
Yes-limited	High	High	Low	Med.	Willows in general are good browse and provide excellent cover for many species
Yes-limited	High	High	Low - Med.	Low	Willows in general are good browse and provide excellent cover for many species

References:

Brunsfeld, S.J. and F.D. Johnson. 1985. *Field Guide to the Willows of East-Central Idaho*. Forest, Wildlife & Range Experiment Station. University of Idaho Bull. #39.

Ditterberner, P.L. and M.R. Olson. 1983. *The Plant Information Network (PIN) Data Base Colorado, Montana, North Dakota, Utah, and Wyoming*. U.S. Fish & Wildlife Service FWS/OBS-83/36.

Platts, W. and Others. 1987. *Methods for Evaluating Riparian Habitat With Applications to Management*. USDA, Forest Service, Intermountain Research Station, General Technical Report INT-221.

USDA Natural Resources Conservation Service. 1992. *Soil Bioengineering for Upland Slope Protection and Erosion Protection*. USDA NRCS Engineering Field Handbook. Chapter 18.



Table 4-1b Woody Species for Bioengineering in the Great Basin and Intermountain West

Species	Size/Form	Elevation Range ¹	Root Type	Rooting Ability from cuttings	Availability In Field ²
<i>Salix boothii</i> Booth willow	Med. Shrub	Mid.	Shallow to Deep	Moderate	Very Common
<i>Salix brachycarpa</i> Barrenground willow	Sm. Shrub	High	Shallow	Good	Common
<i>Salix drummondiana</i> Drummond willow	Sm. - Med. Shrub	Mid. - High	Shallow to Deep	Good	Common
<i>Salix exigua</i> Sandbar willow	Med. Shrub	Low - Mid.	Rhizomatous	Very Good	Very Common
<i>Salix geyeriana</i> Geyer willow	Med.. Shrub	Mid.	Shallow to Deep	Good	Very Common
<i>Salix glauca</i> Grayleaf willow	Sm. - Med. Shrub	Mid. - High	Shallow to Deep	Need to treat with hormone	Fairly Common
<i>Salix lasiandra</i> Pacific willow	Sm. Tree	Low - Mid.	Shallow to Deep	Good	Common
<i>Salix lasiolepis</i> Arroyo willow	Med. Shrub	Low	Shallow to Deep	Moderate	Common
<i>Salix lemmonii</i> Lemmon willow	Sm. - Med. Shrub	Mid. - High	Shallow to Deep	Good	Fairly Common
<i>Salix lutea</i> Yellow willow	Med. - Lg. Shrub	Low	Shallow to Deep	Good	Very Common
<i>Salix planifolia</i> Planeleaf willow	Sm. Shrub	Mid. - High	Shallow to Deep	Moderate	Fairly Common
<i>Salix scouleriana</i> Scouler willow	Lg. Shrub	Low - Mid.	Shallow to Deep	Need to treat with hormone	Fairly Common
<i>Salix wolfii</i> Wolf willow	Sm. Shrub	High	Shallow to Deep	Erratic	Fairly Common
<i>Sambucus coerulea</i> Blue elderberry	Sm. Tree	Mid.	Rhizomatous	Poor	Fairly Common
<i>Sambucus racemosa</i> Red elderberry	Med. Shrub	Mid. - High	Spreading	Poor	Fairly Common
<i>Shepherdia argentea</i> Silver buffaloberry	Lg. Shrub	Low - Mid.	Rhizomatous	Poor	Fairly Common

Footnotes:

U = Unknown

- Elevation Range:** data for this region.
 Low 2,000-4,500 feet
 Middle 4,500-7,000 feet
 High 7,000-10,000 feet
- Availability in the Field:** This refers to its natural occurrence in the region. This is particularly important for species that may be harvested for hardwood cuttings. The order of the ranking is from least to greatest:
 Fairly Common
 Common
 Very Common

- Commercial Availability:** This refers to whether or not it is currently available in the nursery trade. Refer to the Resource section for information on a nursery guide.
- Tolerance to Deposition:** Regrowth from shallow coverage by soil.
- Tolerance to Flooding:**
 High Damage after 10 to 30 days of flooding
 Medium Damage after 6 to 10 days of flooding
 Low Damage after 1 to 5 days of flooding
- Tolerance to Drought:** Resistance to drought relative to native vegetation on similar sites.
- Tolerance to Salinity:** Resistance to salinity relative to native vegetation on similar sites.



Commerical Availability ³	Deposition Tolerance ⁴	Flooding Tolerance ⁵	Drought Tolerance ⁶	Salinity Tolerance ⁷	Wildlife Value/Misc. Notes
Yes-limited	High	Med. - High	Low - Med	Low	Willows in general are good browse and provide excellent cover for many species
No	High	Med. - High	Low - Med.	Low	Willows in general are good browse and provide excellent cover for many species
Yes-limited	High	Med. - High	Low - Med	Low	Willows in general are good browse and provide excellent cover for many species
Yes	High	Med. - High	Low - Med.	Low	Willows in general are good browse and provide excellent cover for many species
Yes-limited	High	Med. - High	Low - Med	Low	Willows in general are good browse and provide excellent cover for many species
U	High	Med. - High	Low - Med.	Low	Willows in general are good browse and provide excellent cover for many species
Yes	High	Med. - High	Low - Med	Low	Willows in general are good browse and provide excellent cover for many species
Yes	High	Med. - High	Low - Med.	Low	Willows in general are good browse and provide excellent cover for many species
No	High	Med. - High	Low - Med	Low	Willows in general are good browse and provide excellent cover for many species
Yes-limited	Med.	Med. - High	Low - Med.	Med.	Willows in general are good browse and provide excellent cover for many species
No	High	Med. - High	Low - Med.	Low	Willows in general are good browse and provide excellent cover for many species
Yes	High	Med. - High	Low - Med.	High	Willows in general are good browse and provide excellent cover for many species
No	High	Med. - High	Low - Med	Low	Willows in general are good browse and provide excellent cover for many species
Yes	Med.	Med.	Med.	Low	Fruits are important for birds
Yes	Med.	Med.	Med.	Low	Big game browse Fruits eaten by birds and small mammals
Yes	U	U	U	Low	Fruits eaten by birds and small mammals

References:

- Brunsfeld, S.J. and F.D. Johnson. 1985. *Field Guide to the Willows of East-Central Idaho*. Forest, Wildlife & Range Experiment Station. University of Idaho Bull. #39.
- Ditterberner, P.L. and M.R. Olson. 1983. *The Plant Information Network (PIN) Data Base Colorado, Montana, North Dakota, Utah, and Wyoming*. U.S. Fish & Wildlife Service FWS/OBS-83/36.
- Platts, W. and Others. 1987. *Methods for Evaluating Riparian Habitat With Applications to Management*. USDA, Forest Service, Intermountain Research Station, General Technical Report INT-221.
- USDA Natural Resources Conservation Service. 1992. *Soil Bioengineering for Upland Slope Protection and Erosion Protection*. USDA NRCS Engineering Field Handbook. Chapter 18.



Table 4-2 Herbaceous Species for Bioengineering in the Great Basin and Intermountain West

Species	Elevation Range ¹	Root Type	Hydrologic Regime ²	Availability In Field ³	Commerical Availability ⁴
<i>Beckmannia syzigachne</i> Sloughgrass	Low-Mid.	Stoloniferous Annual	Seasonally-Flooded	Fairly Common	Yes-Seed & Potted
<i>Calamagrostis canadensis</i> Blue-joint reed grass	Mid.-High	Rhizomatous Perennial	Seasonally-Saturated	Common	Yes-Seed & Potted
<i>Carex aquatilis</i> Water sedge	Mid.-High	Rhizomatous Perennial	Up to 3" Water Depth	Fairly Common	Yes-Seed & Potted
<i>Carex nebrascensis</i> Nebraska sedge	Low-High	Rhizomatous Perennial	Seasonally-Saturated	Common	Yes-Seed & Potted
<i>Carex utriculata</i> Beaked sedge	Low-High	Rhizomatous Perennial	Seasonally-Saturated	Common	Yes-Potted
<i>Deschampsia cespitosa</i> Tufted hairgrass	Mid.-High	Fibrous Perennial	Seasonally-Saturated	Common	Yes-Seed
<i>Distichils stricta</i> Inland Saltgrass	Low-Mid.	Rhizomatous Perennial	Seasonally-Saturated	Very Common	Yes-Seed & Potted
<i>Eleocharis palustris</i> Spikerush	Low-High	Rhizomatous Perennial	Up to 6" Water Depth (maybe more)	Very Common	Yes-Seed & Potted
<i>Glyceria striata</i> Mannagrass	Mid.-High	Rhizomatous Perennial	Seasonally-Flooded	Fairly Common	Yes-Seed & Potted
<i>Juncus balticus</i> Baltic rush	Low-High	Rhizomatous Perennial	Seasonally-Saturated	Very Common	Yes-Seed & Potted
<i>Juncus mertensianus</i> Merten's rush	Mid.-High	Rhizomatous Perennial	Saturated	Fairly Common	Yes-Seed & Potted
<i>Juncus tenuis</i> Poverty rush	Mid.-High	Rhizomatous Perennial	Saturated	Fairly Common	Yes-Potted
<i>Puchinella nuttalliana</i> Alkali grass	Low-Mid.	Fibrous Perennial	Seasonally-Saturated	Common	Yes-Seed & Potted
<i>Scirpus acutus</i> Hard-stem bulrush	Low-High	Rhizomatous Perennial	Up to 36" Water Depth	Very Common	Yes-Seed & Potted
<i>Scirpus maritimus</i> Alkali bulrush	Low-Mid.	Rhizomatous Perennial	Up to 6" Water Depth	Common	Yes-Seed & Potted
<i>Scirpus pungens</i> Three-square bulrush	Low-Mid.	Rhizomatous Perennial	Up to 6" Water Depth	Very Common	Yes-Seed & Potted
<i>Spartina pectinata</i> Prairie cordgrass	Low-Mid.	Rhizomatous Perennial	Seasonally-Flooded	Fairly Common	Yes-Seed & Potted
<i>Typha latifolia</i> Cattail	Low-Mid.	Rhizomatous Perennial	Up to 12" Water Depth	Very Common	Yes-Seed & Potted
<i>Verbena hastata</i> Blue vervain	Low-Mid.	Fibrous Perennial	Seasonally-Saturated	Common	Yes-Seed & Potted

Footnotes:

U = Unknown

- Elevation Range:** data for this region.
 Low 2,000-4,500 feet
 Middle 4,500-7,000 feet
 High 7,000-10,000 feet

- Hydrologic Regime:** This indicates optimal moisture conditions although local conditions are the best benchmarks for design.
 Seasonally-saturated species prefer soil that is saturated early in the season but later dries out. Seasonally-Flooded species prefer flooding in the early portion of the season. Saturated conditions indicates species that prefer saturated conditions all

- Availability in the Field:** This refers to natural occurrence in the region. The order of the ranking is from least to greatest:

Fairly Common
 Common
 Very Common

- Commercial Availability:** This refers to whether or not this species is currently available in the nursery trade. Refer to the Resource section for information on a nursery guide.
- Rate of Spread:** This refers to the horizontal rate of growth. These rates are only guidelines since rates will vary with growing season, elevation, soil, etc.
 Rapid Over 1.0 ft. per year
 Medium Approximately 0.5 ft. per year
 Slow Approximately 0.2 ft. per year
- Tolerance to Acidity:** Resistance to acidity relative to native vegetation on similar sites.
- Tolerance to Salinity:** Resistance to salinity relative to



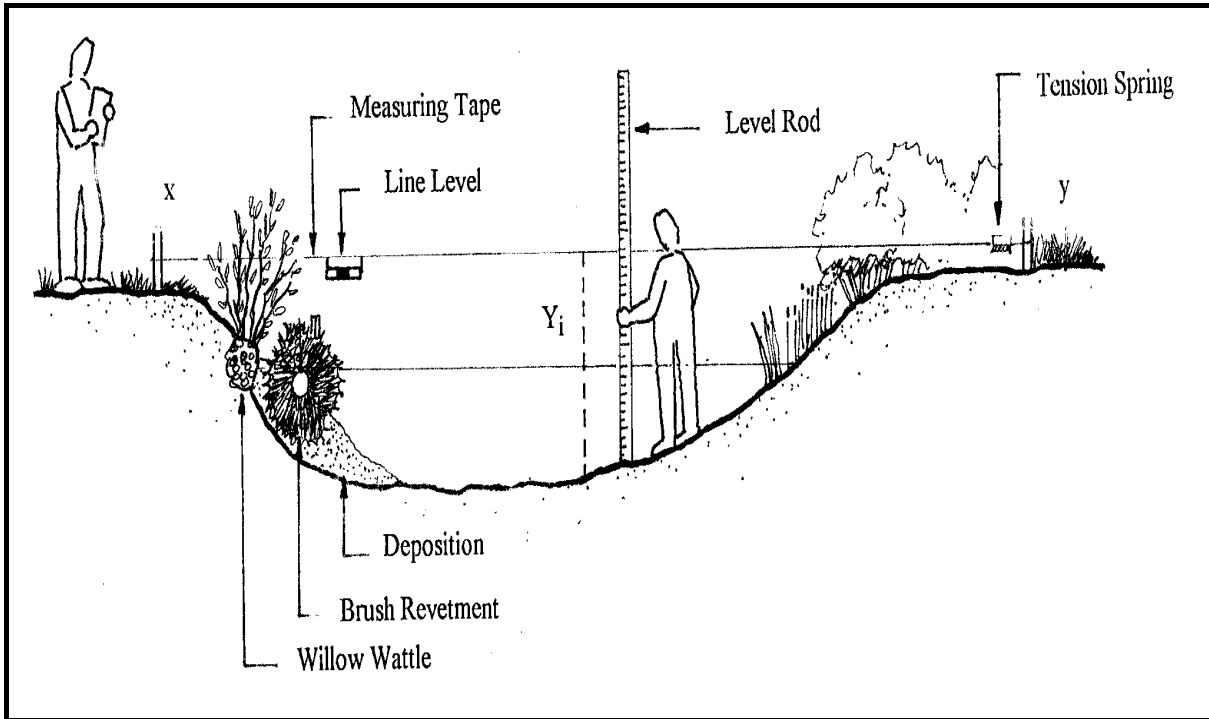
Height	Rate of Spread ⁵	Acidity Tolerance ⁶	Salinity Tolerance ⁷	Wildlife Value	Notes
36"	Rapid	U	U	Waterfowl and small mammal food	Palatable forage grass
24-36"	Medium	Med.	Low	Small mammal food and upland bird cover	Excellent soil stabilizer
10-24"	Medium	Med.	Low	Waterfowl food and cover	
10-24"	Medium	Low	Medium	Waterfowl food and cover, small mammal cover	Tolerates heat if provided with adequate moisture
10-40"	Rapid	Med.	Low	Waterfowl and small mammal food	Also known as <i>C. rostrata</i>
18-30"	Medium	Med.	Med.	Small mammal cover	
12-18"	Medium	Low	High	Waterfowl food	
6-30"	Rapid	Low	Med.	Waterfowl food	Excellent soil stabilizer
24-36"	Rapid	U	Low	Waterfowl and big game food	Excellent soil stabilizer
18-24"	Medium	Med.	Med.	Waterfowl food	Tolerates wide range of hydrologic conditions
4-16"	Medium	U	U	U	
6-12"	Medium	U	U	U	
6-12"	Medium	Low	High	Small mammal cover	Tolerates high alkaline sites
Up to 6'	Rapid	Low	Med.	Waterfowl food and cover, small mammal cover	Excellent soil stabilizer
24-36"	Medium	Low	High	Waterfowl cover and food	Tolerates high alkaline sites
24-48"	Rapid	Low	Med.	Waterfowl food and cover, small mammal cover	Tolerates some hydrologic drawdown
24-48"	Rapid	Low	Med.	Small game cover	Not palatable for livestock
Up to 6'	Rapid	Med.	High	Waterfowl food and cover, small mammal cover and food	Can be invasive
18-30"	Slow	U	Low	Upland bird food	Very fibrous root system

References:

Ditterberner, P.L. and M.R. Olson. 1983. *The Plant Information Network (PIN) Data Base Colorado, Montana, North Dakota, Utah, and Wyoming*. U.S. Fish & Wildlife Service FWS/OBS-83/36.

Cronquist, A., A.H. Holmgren, N.H. Holmgren, J.L. Reveal, and P.K. Holmgren. 1994. *Intermountain Flora: Vascular Plants of the Intermountain West: The Monocotyledons-Volume 6*. Columbia University Press, New York.





Crew surveying cross-section of the stream to determine effectiveness of the treatment. While surveying, the crew will also look for maintenance

Chapter Five

Maintenance and Monitoring



Maintenance and Monitoring

MAINTENANCE

A newly installed bioengineering project will require some initial maintenance. Once vegetation is established, it generally becomes self-sustaining through regrowth and requires little to no maintenance. The establishment period varies from location to location. Common maintenance tasks are shown below. Some replanting is usually necessary to ensure

Maintenance Tasks

1. Clear debris around plantings.
2. Secure stakes, wire, twine, etc.
3. Control weeds.
4. Repair fences.
5. Replant.

the streambank is fully vegetated in a short time frame. The need to replant should not be looked at as a failure. In the Great Basin and Intermountain West, fluctuating stream levels from year to year influence the success of new riparian plantings. Planting success varies greatly from project to project. The following table illustrates some potential success rates for bioengineering. Your project's success should be weighed against the project's goals. Even one willow cutting that survives is an improvement in an area where riparian vegetation was absent.

Potential Success Rates

<u>Method</u>	<u>Growing</u>
Pole Plantings	70-100%
Live Fascines	20-50%
Brush layers	40-70%
Post Plantings	50-70%

Source: NRCS Engineering Field Handbook, Chap. 18

MONITORING

Periodic monitoring of the project site will provide valuable insight into the streambank stabilization process and important information for future projects. All too often, monitoring of stream restoration and bioengineering projects is neglected.

There are several reasons why projects are not monitored. There is a misconception that monitoring is expensive and time consuming. Many project managers and designers may not want to evaluate the project in case the project does not meet all of the objectives and may be perceived as a "failure" (Kondolf 1995a). In reality, there is no such thing as a failure if something is learned from each project.

Kondolf (1995b) outlines five key elements for effective evaluation of stream restoration projects: clear objectives, baseline data, good study design, commitment to the long term, and willingness to acknowledge and accept "failures".

Clear Objectives

A set of clear objectives is the most critical component of an evaluation program because it provides the benchmarks against which the project will be assessed. Project objectives should be clearly stated, not only in qualitative terms, but also quantitatively where possible.



Stating an objective such as "to improve fish habitat" is an acceptable goal in the early planning phase. However, more specific objectives are needed to design a realistic evaluation program.

Baseline Data

Project success can only be determined with reference to prior conditions. Baseline data is necessary for the planning and design phase of a project and provides a solid basis for future monitoring efforts. Establishing permanent photo points before restoration is very valuable for visually documenting changes over time. Stream cross-sections taken before construction can also be used to assess future changes in bank stability.

Good Study Design

A good study design does not need to result in a complex and elaborate evaluation program. Often a simple set of photo points and cross-sections, both upstream and downstream of the treatment area, can serve as baseline reference sites to be compared against the treatment area. Being able to document erosion rates in treated areas versus untreated areas can often be used to promote future projects. A simple and cost-effective method to measure erosion rates is the use of metal pins (Fig. 5.1) (Gordon et al. 1992).

Long-Term Commitment

Evaluation programs require long-term commitment to fully assess the effects of a restoration project. Riparian vegetation requires a few years of growth before success can be fully evaluated. Consequently, monitoring methods must be kept simple and cost-effective if they are to be repeated over several years. For example, measurements do not need to be collected each year but could be collected in alternate years. Monitoring can also be carried out by volunteer groups once they are trained. Many high school science and university classes would probably relish

the opportunity to apply some of their lessons in a real setting.

Willingness to Acknowledge "Failures"

There should be a willingness to acknowledge when projects do not meet all objectives so that important lessons can be transferred to future projects. It should also be noted that due to the dynamic nature of streams and rivers, a very large flood in the first year may wash out a project before the roots have had a chance to stabilize the bank. This does not necessarily mean the project was a failure or poorly designed. It also does not necessarily imply the streambank should have been armored with riprap or concrete. Where possible, we must always strive for multiple objectives such as wildlife and fisheries habitat and water quality improvement in addition to bank stability.

Evaluation Criteria and Methods

Briggs (1996) offers some examples of

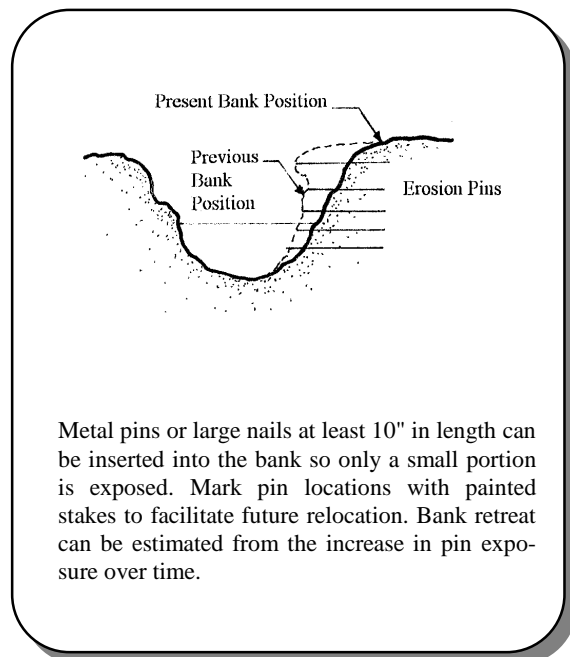


Fig. 5.1 Use of Metal Pins to Monitor Bank Erosion



evaluation criteria for different project objectives. These include:

Channel Capacity and Stability. Criteria may include channel cross-sections, flood stage surveys, rates of bank or bed erosion, longitudinal profile, and aerial photography interpretation.

Improve Aquatic Habitat. Criteria may include water depth, water velocities, percentage of overhanging cover, increases in large woody debris, shading, stream temperatures, bed material composition, and population assessments for fish and invertebrates.

Improve Riparian Habitat. Criteria may include percentage of vegetative cover, species diversity, species densities, survival of plantings, size distribution, age-class distribution, and wildlife use.

Improve Water Quality. Criteria may include temperature, pH level, conductivity, dissolved oxygen concentration, nitrogen and phosphorus concentrations, and turbidity.

Recreation and Community Involvement. Criteria may include visual resource improvement and recreational use surveys.

Since most projects have several objectives, the

project manager may need to select a few key criteria to measure each objective. Since the emphasis of this guide is on bank stabilization, bank morphology and vegetation are key factors to monitor. The following section offers some guidelines for evaluating these parameters.

Bank Morphology

Beginning at the design phase of the project, a base map of the project area should be available. This map can be used during monitoring to record specific notes and locations of stream cross-sections or transects.

Cross-sections can be taken at the project area to document changes in channel width, bank shapes, deposition, and erosion. Cross-sections should be taken perpendicular to the flow of water. Usually, three cross-sections are taken in each treatment area: at the upstream end, middle, and downstream end, in addition to untreated reference areas.

To take a cross-section, two people, a line level, steel measuring tape, tension scale, stakes, twine, and a level rod are desirable (Refer to Fig. 5.2). First, determine a cross-section location and place a stake on both sides of the stream. Mark the location on the base map. Use permanent stakes that can be located during the following monitoring seasons. Secure the end of the steel measuring tape to

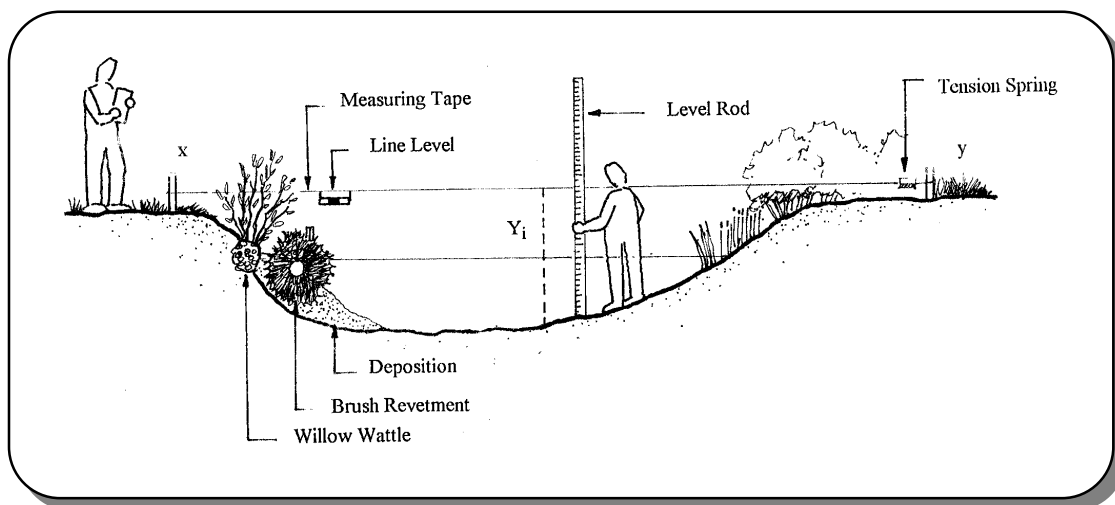


Fig. 5.2 Acquiring Cross-sectional Data



the left side stake and stretch the tape across the channel. Use a line level to level the measuring tape. Using a tension scale, pull the tape until 10 to 20 pounds of tension is obtained and secure to the right stake. Record the height of the tape by both stakes (x, y) so the tape can be set to that height during following evaluations. This line will become the permanent datum for future measurements.

The other person should take level rod readings (Y_i) starting at the left bank. Usually readings are taken every foot to allow for a detailed cross-section. This data can then be plotted to scale on graph paper or on the sample monitoring sheet. Generally, the drawing of the cross-section should use the same horizontal and vertical scales to avoid exaggeration of features.

Drawings of the channel cross-sections can be visually compared from season to season to assess changes in bank morphology. For example, when some streams degrade, they tend to become wide and shallow. If the transects of the treatment area begin to show that the stream is becoming narrower and deeper, this may indicate a positive change depending on the specific context and objectives.

One way to compare pre-treatment and post-treatment cross-sections is simply by using a light table. If the cross-sections are taken at the same location using the same datum and scale, the cross-sections can be overlaid on a light table. A planimeter can be used to measure changes in area due to erosion or deposition.

Mathematical methods for quantifying channel morphology are also available. Several are described by Olson-Runtz and Marlow (1992).

In addition to monitoring channel geometry, it may be worthwhile to document peak flows that have occurred at the bioengineering project. If a gauging station is nearby, data can be acquired from it and used to determine the discharge and approximate velocity based on the known channel geometry. If a gauging station is not available, an inexpensive crest stage gauge can be constructed from a PVC tube. Briggs (1996) outlines the construction of a crest stage gauge which is a simple device constructed of a hollow tube mounted on a strong post that is anchored in the streambed (Fig. 5.4). Inside the tube, a strip of Velcro and a staff gauge are mounted while the bottom has a perforated cap. Small Styrofoam beads (chopped Styrofoam in a blender) are placed

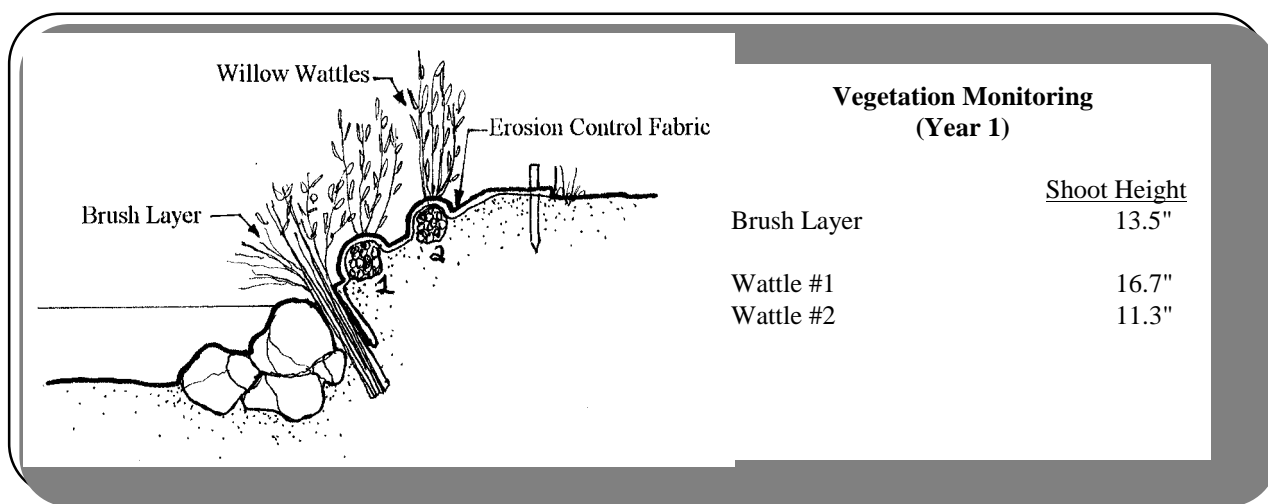


Fig. 5.3 Example of Vegetation Monitoring



inside the tube. When a flow event occurs, water fills the tube and the beads float. As the flood recedes, the beads adhere to the Velcro strip recording the crest stage of the flood. By using at least three crest stage gauges, a slope of the flood peak can be obtained (Briggs 1996). Using Manning's equation and the tractive force equation, discharge and shear stress can be estimated.

Vegetation

Another key component to evaluate is the vegetation. Different methods can be used to assess the success of the revegetation techniques including simple measurements of stem height, stem density, and vegetative cover (Refer to Fig. 5.3). Specific methods for vegetation sampling that may be particularly useful for bioengineering projects include visual estimation of percentage cover, line intercept, and quadrats. Many of these techniques are described in various publications (Gordon et al. 1992, Chambers and Brown 1983).

Many of the vegetative components of bioengineering are planted in a linear row (i.e.

wattles, brush layer, etc.) and lend themselves to techniques such as measuring the number of live stems per linear foot of treatment. Table 5.1 offers some suggestions for monitoring different types of treatments. Permanent photo points should also be used.

Monitoring Resources

A good resource for additional information on evaluating riparian areas is the publication entitled *Methods for Evaluating Riparian Habitats With Applications to Management* (Platts et al. 1987). See the Resource section for information on additional monitoring guides.

Sample Monitoring Sheet

A sample monitoring sheet is shown on the following page. A blank copy of the sheet can be found in Appendix C. The monitoring sheet is only an example and can be tailored for specific projects.

Monitoring is a critical component of restoration and with a little imagination, it can be done in a cost-effective manner using simple tools and volunteers.

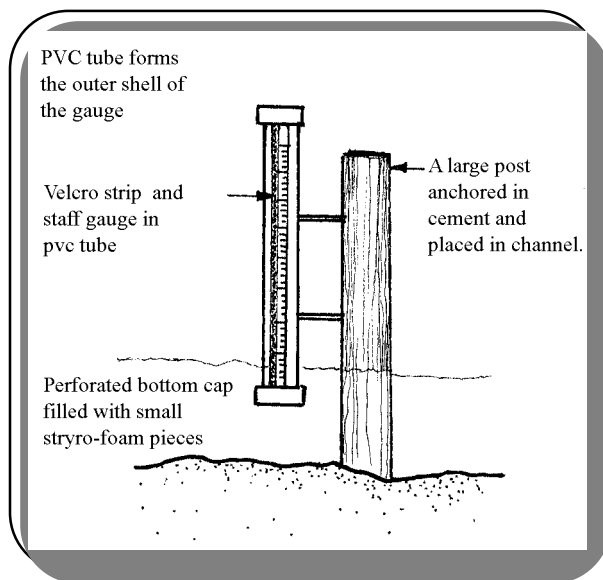


Fig. 5.4 Crest Stage Gauge
Adapted from Briggs (1996)

Table 5.1 Potential Evaluation Methods

Bioengineering Technique	Evaluation Method
Brush Layer	B,C,D
Brush Trench	B,C,D
Vertical Bundles	C
Willow Wattles	B,C,D
Pole Plantings	A,C
Post Plantings	A,C
Brush Mattress	B,C,D

- A. Percent survival of individual plants.
- B. Average number of shoots per linear foot.
- C. Average height of shoots per linear foot.



Bioengineering Monitoring Sheet

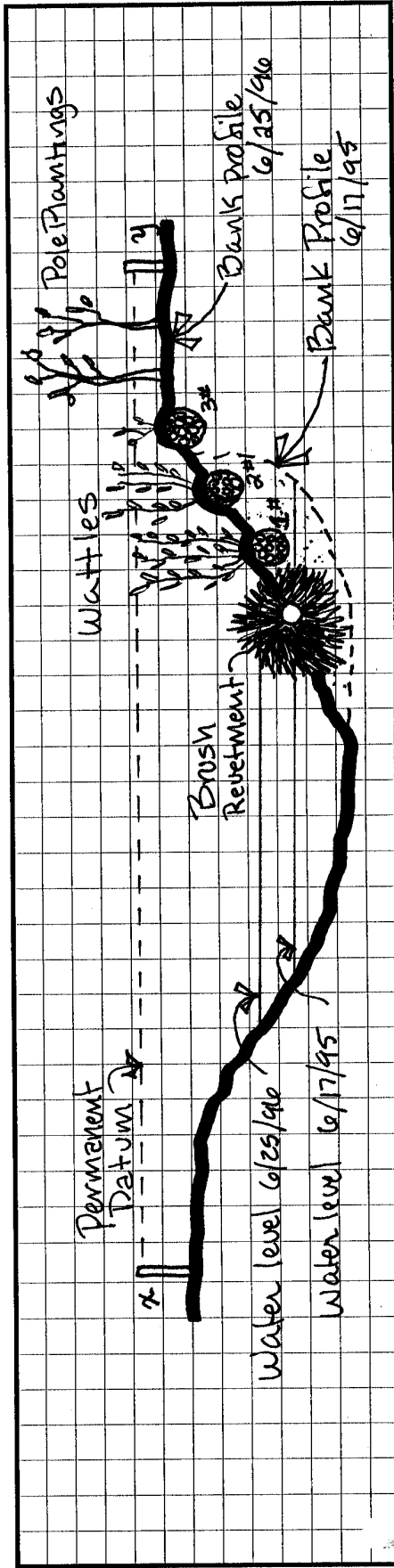
Project Name: Clear Creek - Phase 1 Project Location: Clear ch. S. of Hwy 95 Bridge
 Monitoring Team: Clear Creek H.S. Biology Class Date: 6/25/96

Bioengineering Technique: Brush revegetment w/ willow wattles & pole plantings
 Riparian Species Present: Salix exigua (Sandbar willow wattles) Populus fremontii (Fremont Cottonwood pole plantings) Misc. species - Carex nebrascensis (Nebraska Sedge)

Total # of poles or post plantings: 24 Average # of live stems per linear foot: Wattle #1 (12/per l.f.)
 # of dead: 3 # of live: 21 Wattle #2 (8/per l.f.) wattle #3 (2/per l.f.)
 % survival: 87.5% Average height of stems per linear foot: wattle #1 (27.4")
 Average height: 3.4' Wattle #2 (23.5") wattle #3 (4")
 Stem density per unit area: -NA-

Notes: Brush revegetment & erosion control fabric is holding up & is catching sediment.
Wattles #1 & 2 are doing great - wattle #3 is struggling. Probably should
have planted pole plantings instead of wattle #3 (probably not enough moisture).
Water temp. seems cooler now that channel narrower & deeper - need to
do some temp. monitoring to assess this!

STREAM CROSS-SECTION ID#: 1-A Measuring Tape Height: x 18" y 14"



Scale: Horiz. 1" = 5'-0"
 Vert. 1" = 5'-0"

Fig. 5-5 Bioengineering Monitoring Sheet

Glossary

Aggradation: To fill and raise the level of the bed of a stream by deposition of sediment.

Alluvial: Deposited by running water.

Bankfull Discharge: The discharge corresponding to the stage at which the natural channel is full. This flow typically has a recurrence interval of 1.5 to 2 years.

Best Management Practices: A practice used to reduce the impacts from a particular land use.

Bioengineering: The integration of living woody and herbaceous materials along with organic and inorganic materials to increase the strength and structure of soil.

Buffer: A vegetated area of grass, shrubs, or trees designed to capture and filter runoff from surrounding land uses.

Canopy: The overhead branches and leaves of vegetation.

Capillary Fringe: The distance water is wicked upwards above the water table by capillary action in the soil.

Coir: A woven mat of coconut fibers. Used for various soil erosion control applications. Biodegrades after a period of time.

Degradation: The process of by which stream beds lower in elevation. Opposite of aggradation.

Deposition: The settlement of material out of water.

Fiberschine: A sausage-like bundle of coconut fibers woven together. Used to stabilize the toe of a streambank.

Geomorphology: The geologic study of the evolution and configuration of land forms.

Habitat: The area or environment in which an

organism lives.

Headcutting: The cutting of the streambed to a lower elevation.

Incised Channel: A stream that has cut its channel into the bed of a valley.

Nonpoint Source Pollution: Pollution that originates from many diffuse sources.

Piping: Flow of water through subsurface conduits in the soil.

Reach: A short length of stream that has similar physical and biological characteristics.

Riparian Area: A riparian area is an ecosystem situated between aquatic and upland environments that is at least periodically influenced by flooding.

Scour: Erosive action of flowing water in a stream.

Seepage: Groundwater emerging from the face of a streambank.

Substrate: The mineral and organic material that from the bed of a stream.

Thalweg: A longitudinal line that follows the deepest part of the channel of a stream.

Tractive Force: The drag or force on a streambank or bed particles caused by flowing water.

Velocity: The distance that water travels in a given direction in a stream during a given interval of time.

Watershed: An area of land that drains into a particular river or stream, usually divided by topography.

Wattle: A sausage-like bundle of plant cuttings used to streambanks and other slopes.



Resources

BIOENGINEERING AND WATERSHED RESTORATION TECHNIQUES

Note: Phone numbers, addresses and prices are given for many of the publications. In the case with some of the non-governmental publications, these resources can usually be ordered from your local bookstore.

Stream Corridor Restoration Handbook. Available in 1998. An excellent, comprehensive technical resource developed by several federal agencies. Contains restoration technology applicable for streams in both urban and rural settings. For more information, visit web site (www.usda.gov/stream_restoration).

A Guide to Field Identification of Bankfull Stage in the Western U.S. A useful video for field identification of bankfull discharge. Source USFS Streams Systems Technology Center, Rocky Mountain Station, 240 West Prospect, Ft. Collins, CO 80525.

Better Trout Habitat: A Guide to Stream Restoration and Management. 1990. A 320 page book by C. Hunter that examines in-stream trout habitat restoration practices. Includes case studies. Source: Island Press, Box 7, Covelo, CA 95428 or call (800) 828-1302 (soft cover - \$24.94).

Biotechnical Slope Protection and Erosion Control. 1989. A good technical book by D. Gray and A. Leiser on the scientific principles behind bioengineering. Source: Krieger Publishing Co., Krieger Drive, Malabar, FL 32950.

A Citizen's Streambank Restoration Handbook. 1995. A 111 page grassroots guide for streambank stabilization projects using bioengineering techniques by K. Firehock and J. Doherty. Source: Izaak Walton League of America, Save Our Streams Program, 707 Conservation Lane, Gaithersburg, MD 20878-2983 or call (301) 548-0150 (notebook-\$15).

Guidelines for Bank Stabilization Projects in the Riverine Environments of King County. 1993. A 195 page manual developed by A.W. Johnson and J.M. Stypula to help professionals with the design of bank stabilization projects for streambank protection. Although geared to the Northwest, principles can be applied to other areas. Source: King County Department of Public Works, Surface Water Management Division, 700 Fifth Avenue, Suite 2200, Seattle, WA 98104 or call (206) 296-6519 (soft cover - \$21.65)

Biotechnical & Soil Engineering Slope Stabilization. 1996. An excellent reference guide for bioengineering techniques by D. Gray and R. Sotir. Includes four illustrated case studies. Source: John Wiley and Sons. (hardback - \$64.95).

Water Bioengineering Techniques. 1994. A technical guide originally published in German by H.M. Schiechl and R. Stern. Covers the many different techniques used in Europe; very good resource. Source: Blackwell Science, 239 Main St., Cambridge, MA 02142 (800) 215-1000 (hardback-\$64.95).



Soil Bioengineering for Upland Slope Protection and Erosion Reduction. Chapter 18 - Natural Resources Conservation Service Engineering Field Handbook. 1992. This guide is geared toward upland bioengineering but some information can still be applicable to riparian situations.

Streambank and Shoreline Protection. Chapter 16 - Natural Resources Conservation Service Engineering Field Handbook. 1996. This guide is geared specifically for riparian and shoreline bioengineering. Source: See your local NRCS Conservationist .

'Natural' Channel Design: Perspectives and Practice. 1994. A compilation of the Proceedings of the First International Conference on Guidelines for "Natural Channel Systems" held in Ontario, Canada. This 465 page publication covers both design and policy issues - D. Shrubsole eds. Source: (See IECA under organizations) (soft cover - \$44.95).

Riparian Ecosystem Recovery in Arid Lands: Strategies and References. A 160 page guide to holistic riparian recovery in the Southwest by M. Briggs. Covers critical topics pertaining to arid riparian restoration such as salinity issues. Published by the University of Arizona Press, Tucson, AZ. (soft cover - \$20).

Interagency Riparian/Wetland Plant Development Project. This multi-agency project is aimed at researching plants and techniques for restoration of riparian and wetland ecosystems in the Great Basin and Intermountain West. Project is based at the USDA NRCS Plant Materials Center in Aberdeen, ID. The following publications are available upon request:

Riparian/Wetland Project Information Series

- No. 2** - Selection and acquisition of woody plant species and materials for riparian corridors and shorelines.
- No. 3** - Use of willow and cottonwood cuttings for vegetating shorelines and riparian areas.
- No. 4** - How to plant willows and cottonwoods for riparian rehabilitation.
- No. 5** - Collection, establishment, and evaluation of unrooted woody cuttings to obtain performance tested ecotypes of native willows and cottonwoods.
- No. 6** - Seed and live transplant collection procedures for seven wetland plant species.
- No. 7** - Use of greenhouse propagated wetland plants versus live transplants to vegetate constructed or created wetlands.
- No. 8** - Constructed wetland system for water quality improvement of irrigation wastewater.
- No. 9** - Design criteria for riparian areas of the Intermountain region.
- No. 10** - Seed germination enhancement of *Carex nebrascensis* (Nebraska Sedge)
- No. 11** - Getting "bang for your buck" on your next wetland project.
- No. 12** - Guidelines for planting, establishment, and maintenance of constructed wetlands systems.
- No. 13** - A reference guide for the collection and use of ten common wetland plants of the Great Basin and Intermountain West.

Idaho NRCS Plant Materials Technical Note

- No. 6** - The Stinger, a tool to plant unrooted hardwood cuttings of willow and cottonwood species for riparian or shoreline erosion control or rehabilitation.



No. 23 - How to plant willows and cottonwoods for riparian rehabilitation. (Describes planting methods for willows and cottonwoods in riparian revegetation projects in detail and includes technical references).

Riparian/Wetland Project Plant Guides

***Carex nebrascensis*, Nebraska Sedge** — wetland plant fact sheet. Interagency Riparian/Wetland Plant Development Project, Plant Materials Center, USDA Natural Resources Conservation Service, Box 296, Aberdeen, ID.

***Eleocharis palustris*, Creeping spikerush** — wetland plant fact sheet. Interagency Riparian/Wetland Plant Development Project, Plant Materials Center, USDA Natural Resources Conservation Service, Box 296, Aberdeen, ID.

***Juncus balticus*, Baltic rush** — wetland plant fact sheet. Interagency Riparian/Wetland Plant Development Project, Plant Materials Center, USDA Natural Resources Conservation Service, Box 296, Aberdeen, ID.

***Scirpus acutus*, Hardstem bulrush** — wetland plant fact sheet. Interagency Riparian/Wetland Plant Development Project, Plant Materials Center, USDA Natural Resources Conservation Service, Box 296, Aberdeen, ID.

***Scirpus maritimus*, Alkali bulrush** — wetland plant fact sheet. Interagency Riparian/Wetland Plant Development Project, Plant Materials Center, USDA Natural Resources Conservation Service, Box 296, Aberdeen, ID.

***Scirpus pungens*, Common threesquare** — wetland plant fact sheet. Interagency Riparian/Wetland Plant Development Project, Plant Materials Center, USDA Natural Resources Conservation Service, Box 296, Aberdeen, ID.

Available from: Interagency Riparian/Wetland Plant Development Project, Plant Materials Center, USDA Natural Resources Conservation Service, Box 296, Aberdeen, ID 83210 (208) 397-4133.

GENERAL BACKGROUND

A View of the River. 1994. An easy to read description of rivers based on the lifetime work of L. Leopold. Published by Harvard University Press, Cambridge, MA. (hardback - \$40).

Water in Environmental Planning. 1978. An excellent 818 page hydrological resource authored by L. Leopold and T. Dunne. Published by W.H Freeman and Company, New York. (hardback-\$60).

Stream Hydrology: An Introduction for Ecologists. 1992. A useful 532 page book that explains what hydrologic data to gather and how to use it. Authored by N.D. Gordon, T.A. McMahon, and B. L. Finlayson. Published by John Wiley and Sons, New York.(hardback - \$69.95).

RESTORATION PERIODICALS



Restoration and Management Notes. A biannual publication published by the Society for Ecological Restoration (refer to Organizations). Covers all types of restoration activities. Source: Journal Division, 114 N. Murray St., Madison, WI 53715 (1 year subscription - \$27).

Watershed Protection Techniques. A quarterly journal on urban watershed restoration and protection techniques. Source: Center for Watershed Restoration, 8737 Colesville Road, Suite 300, Silver Springs, MD. 20910 (1 year subscription - \$48).

Land and Water. A magazine covering topics such as erosion control, aquascaping and bioengineering. Source: Land and Water, P.O. Box 1197, Fort Dodge, IA 50501 (1 year subscription -\$14).

Erosion Control. Official journal of the International Erosion Control Association (refer to Organizations). Published seven times a year. Source: Erosion Control, PO Box 3100, Santa Barbara, CA 93130 (1 year subscription-\$36).

LAND USE MANAGEMENT AND BEST MANAGEMENT PRACTICES

Site Planning for Urban Stream Protection. 1995. An excellent 232 page resource on protecting urban streams by T. Schueler. Source: Center for Watershed Restoration, 8737 Colesville Road, Suite 300, Silver Springs, MD 20910 or call (301) 589-1890 (soft cover -\$35).

Riparian Road Guide: Managing Roads to Enhance Riparian Areas. 1994. A 32 page booklet on road building to minimize impacts on riparian areas. Source: Terrene Institute, 4 Herbert St., Alexandria, VA 22305 or call (703) 548-5473. (soft cover - \$10.95).

Restoring The Range 1995. A 40 page supplement to the Citizen's Streambank Restoration Handbook by J. West, published by the Izaak Walton League of America, Save Our Streams Program, 707 Conservation Lane, Gaithersburg, MD 20878-2983 or call (301) 548-0150 (notebook-\$20; price includes the Citizen's Streambank Restoration Handbook).

Idaho Forestry Best Management Practices: Compilation of Research on Their Effectiveness. 1996. A good assessment of forestry BMP by K.A. Seyedbagheri. Source: Rocky Mountain Research Station, 324 25th Street, Ogden, UT 84401. (General Technical Report INT-GTR-339). (soft cover - free).

ASSESSMENT AND MONITORING

Process for Assessing Proper Functioning Condition. 1993. Good process for assessing whether a riparian area is functioning properly. Source: Bureau of Land Management, Service Center, SC-657B, P.O.B. 25047, Denver, CO 80225-0047. (Technical Report 1737-9 1993). (soft cover - free).

Rapid Bioassessment Protocols for Use in Streams and Rivers: Benthic Macroinvertebrates and



Fish. 1989. Discusses various habitat assessment and sampling approaches for fresh water streams and rivers. Source: U.S. Environmental Protection Agency, Assessment and Watershed Protection Division, 4503f, 401 M Street, SW, Washington, DC 20460 or call (202) 260-7081 (EPA 444/4-89-001). (soft cover - free).

Methods for Evaluating Riparian Habitats With Application to Management. 1987. Good resource for scientific monitoring of riparian areas. Source: Rocky Mountain Research Station, 324 25th Street, Ogden, UT 84401. (General Technical Report INT-221). (soft cover - free).

Inventory and Monitoring of Riparian Areas. 1989. Another good resource for monitoring riparian areas. Source: Bureau of Land Management, Service Center, SC-658B, P.O.B. 25047, Denver, CO 80225-0047. (Technical Report 1737-3 1989). (soft cover - free).

Water Quality Indicators Guide: Surface Waters. Simplified approach to assessing water quality based on indicators without the use of elaborate chemical testing procedures. Source: Terrene Institute, orders accepted via phone (703) 548-5473 with payment by credit cards, checks or purchase orders (soft cover - \$26.95).

Field Manual for Water Quality Sampling. A handy little field reference to provide for consistent sampling protocols. Source: Arizona Water Resources Research Center, College of Agriculture, 350 N. Campbell Avenue, University of Arizona, Tucson, AZ 85721 (520) 792-9591.(soft cover - \$10).

A Monitor's Guide to Aquatic Macroinvertebrates. 1992. A 46-page layperson's guide to identifying aquatic insect larvae including an easy-to-use key. Source: Izaak Walton League of America, Save Our Streams Program, 707 Conservation Lane, Gaithersburg, MD. (301) 548-0150. (soft cover - \$5).

HORTICULTURAL INFORMATION

Hortus West. A western United States native plant directory and journal. Source: Hortus West, P.O. Box 2870, Wilsonville OR 97070-9957 or call (800) 704-7927. (1 year subscription \$9.00 or single copy \$6.45).

Field Guide to the Willows of East-Central Idaho. 1985. Great guide for willows that occur in the Intermountain West by Steven Brunfeld and Frederic Johnson. Source: Forest, Wildlife and Range Experiment Station, University of Idaho, Moscow, ID 83843. (Bulletin #39) (\$20 - each).

Planting Guide for Utah. 1994. Good seeding guide for grasses and upland woody plants. Source: Cooperative Extension Service, Utah State University, Logan, UT 84322. (Extension Circular 433).

Native Trees of the Intermountain Region. Good guide for both upland and riparian tree species. Source: Cooperative Extension Service, Utah State University, Logan, UT 84322. (Extension Circular 407).

Classification and Management of Montana's Riparian and Wetland Sites. 1995. Good regional



classification system for Montana by P.L.Hansen and others. Source: The University of Montana, School of Forestry and Montana Forest and Conservation Experiment Station, Missoula, MT. (Miscellaneous Publication No. 54).

Riparian Community Type Classification of Utah and Southeastern Idaho.1989. Good regional classification system by W.G. Padgett. Source: Rocky Mountain Research Station, 324 25th Street, Ogden, UT 84401. (R4-Ecol-89-01) (soft cover - free).

ORGANIZATIONS

Society for Ecological Restoration (SER).

A non-profit organization dedicated to ecological restoration including both upland and riparian landscapes. Contact: SER, University of Wisconsin-Madison Arboretum, 1207 Seminole Highway, Madison, WI 53711. (608) 262-9547.

International Erosion Control Association (IECA). A non-profit organization dedicated to erosion and sediment control. Publishes a directory of erosion control product suppliers. Contact: IECA, Box 774904, Steamboat Springs, CO 80477-4904. (800) 455-4322.



References

- Allen, H.H. and J.R. Leech. 1997. *Bioengineering guidelines for streambank erosion control*. Environmental Impact Research Program Technical Report. U.S. Army Corps of Engineers Waterways Experiment Station. Vicksburg, MS.
- Bentrup, G. 1996. Bioengineered shoreline protection for an urban recreation pond. *Land and Water* 40(1):11-13.
- Beschta, R.L. and W.S. Platts. 1986. Morphological features of small streams: significance and function. *Water Resources Bulletin* 22(3):369-379.
- Best, L.B. and D.F. Stauffer. 1980. Habitat selection by birds of riparian communities: evaluating the effects of habitat alterations. *Journal of Wildlife Management* 44(1): 1-15.
- Binford, M.W. and M.J. Buchenau. 1993. Riparian greenways and water resource. pp. 69-104 in D.S. Smith and P.C. Hellmund eds., *Ecology of greenways: design and function of linear conservation areas*. University of Minnesota Press, Minneapolis, MN.
- Briggs, M.K., B.A. Roundy, and W.W. Shaw. 1994. Trial and error: assessing the effectiveness of riparian revegetation in Arizona. *Restoration and Management Notes* 12(2):160-167.
- Briggs, M.K. 1996. *Riparian ecosystem recovery in arid lands*. University of Arizona Press, Tucson, AZ.
- Brinson, M.M., B.C. Swift, R.C. Plantico, and J.S. Barclay. 1981. *Riparian ecosystems and their ecology and status*. U.S. Fish and Wildlife Service, FWS/OBS 81/17. Kearneyville, WV.
- Brunsfeld, S.J. and F.D. Johnson. 1985. *Field guide to the willows of east-central Idaho*. Bull. 39. Forest, Wildlife, and Range Experiment Station. University of Idaho, Moscow, ID.
- Cannon, R.W. and F.L. Knopf. 1984. Species composition of a willow community relative to seasonal grazing histories in Colorado. *Southwest Naturalist* 29:234-237.
- Carlson, J.R., G.L. Conaway, J.L. Gibbs, and J.C. Hoag. 1995. *Design criteria for revegetation in riparian zones of the Intermountain Area*. USDA NRCS Riparian/Wetland Project Information Series #9, Plant Materials Center, Aberdeen, ID.
- Chambers, J.C. and R.W. Brown. 1983. *Methods for vegetation sampling and analysis on revegetated mined lands*. General Technical Report INT-151, USDA Forest Service, Rocky Mountain Research Station, Ogden, UT.
- Chaney, E., W. Elmore, and W.S. Platts. 1993. *Managing change: livestock grazing on western riparian areas*. Northwest Resource Information Center, Inc., Eagle, ID.
- Chang, H.H. 1992. *Fluvial processes in river engineering*. Krieger Publishing Co, Malabar, FL.
- Chen, Y.H. and G.K. Cotton. 1988. Design of roadside channels with flexible linings. *Hydraulic Engineering Circular No. 15*. Federal Highway Administration, Publication No. FHWA-IP-87-7 USDOT/FHWA, McClean, VA.
- Clark, E.H., J.A. Haverkamp, and W. Chapman. 1985. *Eroding soils: the off-farm impacts*. The Conservation Foundation, Washington, DC.
- Clary, W.P., N. Shaw, J.G. Dudley, V.A. Saab, J.W. Kinney, and L.C. Smithman. 1996. *Response of a depleted sagebrush steppe riparian system to grazing control and woody plantings*. Research Paper INT-RP-492, USDA, Forest Service, Rocky Mountain Research Station, Ogden, UT.
- Clary, W. P. 1995. Vegetation and soil responses to grazing simulation on riparian meadows. *Journal of Rangeland* 48:18-25.
- Cole, D.N. 1993. Minimizing conflict between recreation and nature conservation. pp. 105-122 in



D.S. Smith and P.C. Hellmund eds. *Ecology of greenways: design and function of linear conservation areas*. University of Minnesota Press, Minneapolis, MN.

Cooper, J.R., J.W. Gilliam, R.B. Daniels, and W.P. Robarge. 1987. Riparian areas as filters for agricultural sediment. *Soil Science Society of America Journal* 51:416-420.

Dawson, T.E. and J.R. Ehleringer. 1991. Streamside trees that do not use stream water. *Nature* 350:335-337.

Dittberner, P.L. and M.R. Olson. 1983. *The plant information network (PIN) data base for Colorado, Montana, North Dakota, Utah, and Wyoming*. FWS/OBS-83/36 U.S. Fish and Wildlife Service.

Duff, A. 1980. Construction and operating efficiency of various stream habitat improvement structures in Utah. pp. 153-158 in M.E. Seehorn, eds. *Proceedings of the Trout Stream Habitat Improvement Workshop*. USDA, Forest Service, Atlanta, GA.

Dunne, T. and L.B. Leopold. 1978. *Water in environmental planning*. W.H. Freeman and Company, New York, NY.

Firehock, K. and J. Doherty. 1995. *A citizen's streambank restoration handbook*. Save our Streams, Izaak Walton League of America, Inc., Gaithersburg, MD.

Fischenich, J.C. 1989. Channel erosion analysis and control. pp. 101-109 in Woessmer, W. and D.F. Potts eds. *Symposium Proceedings Headwaters Hydrology*. American Water Resources Association, Bethesda, MD.

Florsheim, J. and R.N. Coats. 1997. Dynamic equilibrium as a model for restoration in rivers and wetlands. pp. 69-82 in S. Sommarstrom ed. *Proceedings of the Sixth Biennial Watershed Management Conference*. University of California, Davis, CA.

Forman, R.T. 1995. *Land mosaics: the ecology of landscapes and regions*. Cambridge University Press, Cambridge, MD.

Fry, J.R. 1938. Willows for streambank control. *Soil Conservation*, IV(5), November.

Gordon, N.D., T.A. McMahon, and B.L. Finlayson. 1992. *Stream hydrology: an introduction for ecologists*. John Wiley and Sons, New York, NY.

Gary, D.H. and R.B. Sotir. 1996. *Biotechnical and soil bioengineering slope stabilization*. John Wiley and Sons, Inc. New York, NY.

Gray, D.H. and A.T. Leiser. 1982. *Biotechnical slope protection and erosion control*. Van Nostrand Reinhold, New York, NY.

Hansen, P.L., R.D. Pfister, K. Boggs, B.J. Cook, J. Joy, and D.K. Hinckley. 1995. *Classification and management of Montana's riparian and wetland sites*. Miscellaneous Publication No. 54. The University of Montana, School of Forestry and Montana Forest and Conservation Experiment Station, Missoula, MT.

Hagerty, D.J. 1991. Piping/sapping erosion I: basic considerations. *Journal of Hydraulic Engineering*. 117(8): 991-1007.

Harpstead, M.I., F.D. Hole, and W.F. Bennett. 1988. *Soil science simplified*. Iowa State University Press, Ames, IA.

Hellmund, P.C. and D.S. Smith eds. 1993. *Ecology of Greenways*. University of Minnesota Press, Minneapolis, MN.

Herson-Jones, L., M. Heraty, and B. Jordan. 1995. *Riparian buffer strategies for urban watersheds*. : Metropolitan Washington Council of Governments, Washington, DC.

Hoag, J.C. 1992. *Use of willow and cottonwood cuttings for vegetation shorelines and riparian areas*. USDA NRCS Riparian/Wetland Project Information Series #3, Plant Materials Center, Aberdeen, ID.

Hoag, J.C. 1993a. *Selection and acquisition of woody plant species and materials for riparian corridors and shorelines*. USDA NRCS Riparian/Wetland Project Information Series #2, Plant Materials Center, Aberdeen, ID.



Hoag, J.C. 1993b. *How to plant willows and cottonwoods for riparian rehabilitation*. USDA Natural Resources Conservation Service, Idaho Plant Materials Technical Note # 23, Boise, ID.

Hoag, J.C. and M. Sellers. 1995. *View from a wetland*. Newsletter for the USDA NRCS Interagency Riparian/Wetland Plant Development Project. NRCS. Plant Materials Center, Aberdeen, ID.

Hunter, C. 1990. *Better trout habitat: a guide to stream restoration and management*. Island Press, Covelo, CA.

Hupp C.R. and W.R. Osterkamp. 1996. Riparian vegetation and fluvial geomorphic processes. *Geomorphology* 14: 277-295.

Johnson, A.S. 1989. The thin green line: riparian corridors and endangered species in Arizona and New Mexico. pp. 35-46 in G. Mackintosh ed. *Preserving Communities and Corridors*. Defenders of Wildlife. Washington, DC.

Johnson, A.W. and J.M. Stypula, eds. 1993. *Guidelines for bank stabilization projects in the riverine environments of King County*. King County Department of Public Works, Surface Water Management Division, Seattle, WA.

Johnson, R.R. and D.A. Jones. 1977. *Importance, preservation, and management of riparian habitat: a symposium*. USDA Forest Service General Technical Report RM-43. Rocky Mountain. Forest. and Range Experiment Station., Fort Collins, CO.

Judy, R.D. Jr., P.N. Seeley, T.M. Murray, S.C. Svirsky, M.R. Whitworth, and L.S. Ischinger. 1984. *1982 National fisheries survey, Vol. 1 technical report: initial findings*. U.S. Department of the Interior, Washington, DC.

Karr, J.R. and I.J. Schlosser. 1978. Water resources and the land-water interface. *Science* 201:229-234.

Kauffman, J.B. and W.C. Krueger. 1984. Livestock impacts on riparian ecosystems and streamside management implications...a review. *Journal of Range Management*. 11:249-256.

Kauffman, J.B., R.L. Case, D. Lytjen., N. Otting, and

D.L. Cummings. 1995. Ecological approaches to riparian restoration in northeast Oregon. *Restoration and Management Notes* 13(1):12-15.

Kondolf, M. 1995a. Learning from stream restoration projects. pp. 107-110 in R. Harris, R. Kattelman, H. Kerner, and J. Woled eds. *Proceedings of the Fifth Biennial Watershed Management Conference*. University of California, Davis, CA.

Kondolf, M. 1995b. Five elements for effective evaluation of stream restoration. *Restoration Ecology* 3(2):133-136.

Kondolf, M. 1996. Appropriate application of fluvial geomorphology in ecosystem recovery efforts. pp. 179 in S. Sommarstrom ed. *Proceedings of the Sixth Biennial Watershed Management Conference*. University of California, Davis, CA.

Kraebel, C.J. 1936. *Erosion control on mountain roads*. U.S. Dept. of Agriculture Circular #380.

Leopold, L.B. M.G. Wolman, and J.P. Miller. 1964. *Fluvial processes in geomorphology*. Dover Publications, New York, NY.

Leopold, L.B. 1994. *A view of the river*. Harvard University Press, Cambridge, MD.

Lev. E. 1995. Youth conservation corps carries out streambank project. *Restoration and Management Notes* 13(1):20-21.

Lowrance, R., R. Lonard, and J. Sheridan. 1985. Managing riparian ecosystems to control nonpoint source pollution. *Journal of Soil and Water Conservation*. 40:87-92.

Marburger, J.E. 1992. *Wetland plant materials technology, needs and development for wetland enhancement, restoration, and creation in cool temperate regions of the United States*. Terrene Institute, Washington, DC.

Mcdonald, M. 1995. A combination in behalf of restoration: the coalition to restore urban waters. *Restoration and Management Notes* 13(1): 98-103.

Minshall, G.W., S.E. Jensen, and W.S. Platts. 1989. *The ecology of stream and riparian habitats of the Great Basin region: a community profile*. Biol. Rep.



85(7.24). U.S. Department of Interior, Fish and Wildlife Service, National Wetlands Research Center, Slidell, LA.

Miller, D. 1996. Design guidelines for bioengineered river bank stabilization. pp 159-168 in *Proceedings of Conference XXVII*, International Erosion Control Association. .

Mitsch, W.J. and J.G. Gosselink. 1993. *Wetlands*. Van Nostrand Reinhold, New York, NY.

Munshower, F.F. 1993. *Practical handbook of disturbed land revegetation*. Lewis Publishers, Ann Arbor, MI.

National Research Council (NRC). 1992. *Restoration of aquatic ecosystems: science, technology, and public policy*. National Academy Press, Washington, DC.

Noss, R.F. 1993. Wildlife corridors. pp 43-68 in D. S. Smith and P.C. Hellmund eds. *Ecology of greenways: design and function of linear conservation areas*. University of Minnesota Press, Minneapolis, MN.

Olson-Rutz, K.M. and C.B. Marlow. 1992. Analysis and interpretation of stream channel cross-sectional data. *North American Journal of Fisheries Management*. 12:55-61.

Padgett, W.G., A.P. Youngblood, and A.H. Winward. 1989. *Riparian community type classification of Utah and Southeastern Idaho*. R4-Ecol-89-01. USDA, Forest Service, Rocky Mountain Research Station, Ogden, UT.

Parsons, P.A. 1963. Vegetative control of streambank erosion. pp. 130-136 in *Federal Interagency Sedimentation Conference: Proceedings*. Misc. Publ. 970. USDA Agricultural Research Service, Washington, DC.

Peterjohn, W.T. and D.L. Correll. 1984. Nutrient dynamics in an agricultural watershed: observations on the role of a riparian forest. *Ecology* 65:1466-1475.

Platts, W.S. 1981. *Effects of sheep grazing on a riparian-stream environment*. Research Note INT-

307, USDA Forest Service, Rocky Mountain Research Station, Ogden, UT.

Platts W.S. and F.J. Wagstaff. 1984. Fencing to control livestock grazing on riparian habitats along streams: is it a viable alternative?. *North American Journal of Fisheries Management* 8:240-247.

Platts, W.S. and R.L. Nelson. 1985. Streamside and upland use by cattle. *Rangelands* 7:5-7.

Platts, W.S. and J.S. Rinne. 1985. Riparian and stream enhancement management and research in the Rocky Mountains. *North American Journal of Fisheries Management* 5:115-125.

Platts, W.S. et al. 1987. *Methods for evaluating riparian habitats with applications to management*. General Technical Report INT-221, USDA Forest Service, Rocky Mountain Research Station, Ogden, UT.

Platts, W.S. 1990. *Managing fisheries and wildlife on rangelands grazed by livestock*. Nevada Department of Wildlife.

Rosgen, D.L. 1994. Classification of natural rivers. *Catena* 22:169-199.

Rotar, M.A. 1996. Innovative bioengineering techniques used to restore Boulder Creek, CO. pp. 55-64 in *Proceedings of Conference XXVII*, International Erosion Control Association. .

Schiechtl, H.M. and R. Stern. 1994. *Water bioengineering techniques*. Blackwell Science, Cambridge, MA.

Schueler, T. 1995. *Site planning for urban stream protection*. Metropolitan Washington Council of Governments, Washington, DC.

Seyedbagheri, K.A. 1996. *Idaho forestry best management practices: compilation of research on their effectiveness*. General Technical Report INT-GTR-339, USDA Forest Service, Rocky Mountain Research Station, Ogden, UT.

Shultz, D. 1994. *Multiple benefits from constructed multi-species riparian buffer strips*. Leopold Center



for Sustainable Agriculture, ISU Extension and Department of Forestry. Iowa State University, Ames, IA.

Stabler, F. 1985. Increasing summer flow in small streams through management of riparian areas and adjacent vegetation: a synthesis. pp. 290-294 in R.R. Johnson, C.D. Ziebell, D.R. Patton, P.F. Folliott, and R.H. Harne, eds. *Riparian ecosystems and their management: reconciling conflicting uses*. First North American Riparian Conference. USDA Forest Service, General Technical Report RM-120. Fort Collins, CO.

Stanley, E.H., S.G. Fisher, and N.B. Grimm. 1997. Ecosystem expansion and contraction in streams. *BioScience* 47(7): 427-435.

Szaro, R.C. 1991. Wildlife communities of southwestern riparian ecosystems. pp 175-210 in J.E. Rodiek and E.G. Bolen eds. *Wildlife and Habitats in Managed Landscapes*. Island Press, Washington, DC.

Temple, D.M., K.M. Robinson, R.M. Ahring, and A. G. Davis. 1987. *Stability design of grass-lined open channels*. Agricultural Handbook 667. USDA Agricultural Research Service, Washington, DC.

Thomas, J.W., C.C. Maser, and J.E. Rodiek. 1979. *Wildlife habitats in managed forests: the Blue Mountains of Oregon and Washington*. USDA Forest Service Agriculture Handbook No. 553. Washington, DC.

Thibodeau, F.R. and B.D. Ostro. 1981. An economic analysis of wetland protection. *Journal of Environmental Management*. 12:19-30

USACE. 1981. *Final report to congress: the streambank erosion control evaluation and demonstration act of 1974*. Section 32, PL 93-251.

USDA. 1990. *USDA Plant Hardiness Zone Map*. United States Agricultural Research Service USDA Agricultural Research Service Misc. Publ. N 1475.

USDA. 1992. *Soil bioengineering for upland slope*

protection and erosion protection. USDA Natural Resources Conservation Service Engineering Handbook. Chapter 18.

West, J. 1995. *Restoring the range: a guide to restoring, protecting and managing grazed riparian areas*. Save our Streams, Izaak Walton League of America, Inc. Gaithersburg, MD.



Comment Sheet for The Practical Streambank Bioengineering Guide

1. What areas of the guide need more clarification and/or expansion?

2. Which sections were the most helpful?

3. What techniques sheets should be added in the future?

4. What plant datasheets should be added in the future?

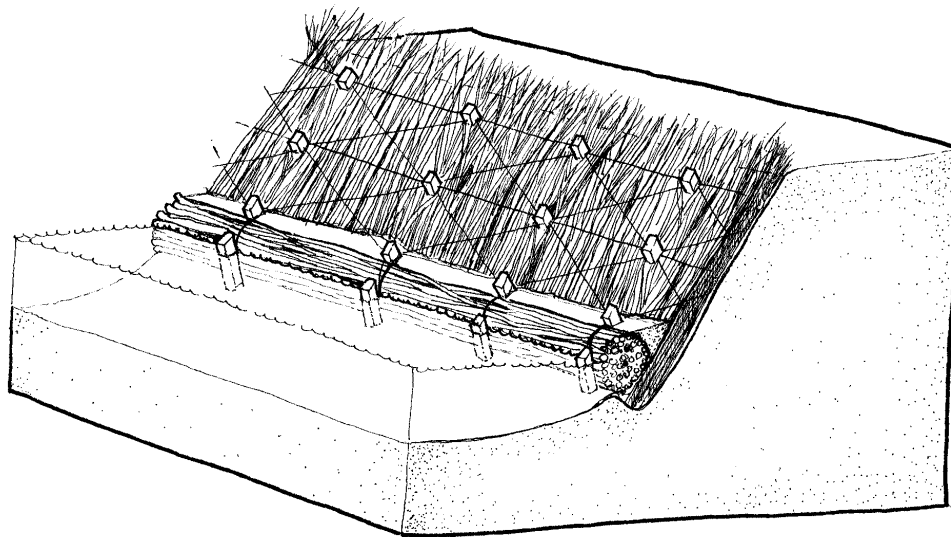
5. What personal experience from bioengineering projects you would like to share with others?

6. Any other comments?

Thanks! Your comments are truly appreciated.

The Practical Streambank Bioengineering Guide

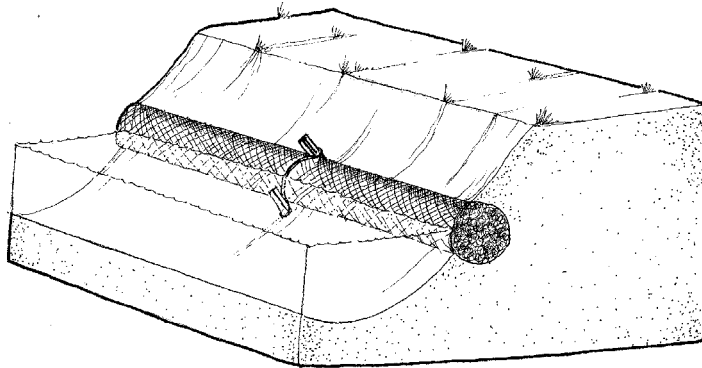
Appendix A Bioengineering Techniques



Brush Mattress



Fiberschine



Materials:

- o fiber rolls or biologs
- o 10-12 gauge wire
- o wood stakes
- o sledgehammer
- o 2 people minimum

Description and Use

This technique uses a coconut-fiber roll product to protect the streambank by stabilizing the toe of the slope and by trapping sediment from the sloughing streambank. Cuttings and herbaceous riparian plants are planted into the fiberschine and behind it. By the time the fiberschine decomposes, riparian vegetation will have stabilized the streambank.

How To Install

1. Determine the length of treatment area and acquire the necessary amount of fiberschines from a supplier. Common tradenames for fiberschines include Biologs and Fiber Rolls. Be sure to order enough fiberschine to allow for 5 feet to extend past each end of the treatment area.

A list of suppliers can be obtained from the International Erosion Control Association listed in the Resource section of this guide. Fiberschines can be purchased in various diameters, with the 12 inch diameter being one of the more popular sizes.

2. Place the fiberschine along the toe of the streambank at approximately the low flow line. Submerge the fiberschine so that approximately 1/2 the fiberschine is below the water line. Place other fiberschines along the bank. Tie the ends of adjacent fiberschines together with strong twine.

3. It is critical to key the ends of the fiberschine into the bank to prevent flows from getting behind it. Both ends should then be protected with something hard such as rock to prevent the ends from being scoured.

4. Secure the fiberschine with 24 to 36 inch long wedge-shaped wooden stakes on both sides of the fiberschine at 5 foot intervals. Cut a 3/4" deep notch in each stake about 5" from the top. Tie twine or wire around each pair of stakes at the notches. Drive the stakes in so that the twine is secured against the top of the fiberschine.

Another option for securing the fiberschines is to use cable and soil anchors. This method will probably secure the fiberschine more firmly into the streambank.

5. Backfill behind the fiberschine by knocking down the top of the streambank onto the fiberschine.

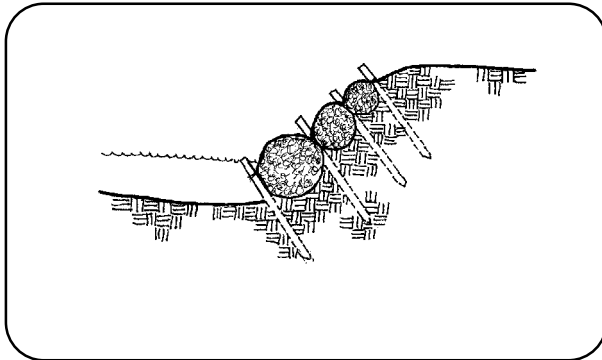
6. Plant herbaceous wetland plants or willows into and behind the fiberschine. Herbaceous plants should be planted approximately 0.5-1 foot on center (see other Technique Sheets).



Fiberschine

Inventory & Planning Considerations

1. Installation of the fiberschine can usually be accomplished throughout the year. High water periods should be avoided for safety reasons.
2. The fiberschine should extend upstream and downstream past the eroded area being treated to prevent flows from getting behind the fiberschine. Analysis and calculations may reveal that additional toe protection is necessary (refer to Chapter 3 of the Streambank Bioengineering Guide). In many cases, rock may be appropriate if placed properly. Improperly placed rock can result in erosion problems on the opposite streambank as well as downstream.
3. Be sure to key the upstream and downstream end of the fiberschine into the streambank and secure it with some hard materials such as tree trunks or large rocks.



Tiered Fiberschine Construction

4. If this method is used in a highly erodible area and bank shaping is not possible, a tiered fiberschine technique may be necessary. Three fiberschines of different diameters are often used but various numbers and combinations of sizes can be used.
5. Never disturb the site unnecessarily. Remember the goal is to stabilize a site. The less it is disturbed,

Management

To ensure the highest success for the treated area, determine the land management practices that created the eroded streambanks and modify those land use practices necessary.

If the area is grazed, restrict livestock from treated areas to allow the eroded section of streambank to heal. Enclosure fences are the most efficient means to accomplish this goal. Managers should resist the temptation to put the enclosure fences at the high water line. The enclosure areas should include enough of the riparian zone to allow the stream to shift naturally over time.

If the area is farmed, a riparian buffer strip should be established and maintained. A buffer strip on both sides of the stream should be set aside to allow for natural riparian vegetation and stream function. A wider buffer strip is strongly encouraged and will yield greater benefits.

Check with your local NRCS district conservationist for cost-share programs and volunteers for fencing, planting, and other restoration activities.

Finally, a stream is an interconnected system and land use practices both upstream and downstream will affect the success of your bioengineering work. Talk with your neighbors and work together to create a healthier riparian and stream system that can benefit everyone.

Monitoring & Maintenance

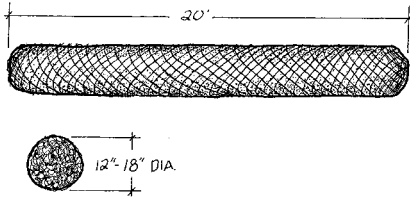
Do not ignore the project after it has been installed. Periodic monitoring of the project will provide valuable insight into the stabilization process and may offer important information for future projects.

Periodic maintenance includes checking on the fiberschine to ensure that the posts and wire are holding the fiberschine in place. Additional native plantings may be necessary to accelerate the healing process.

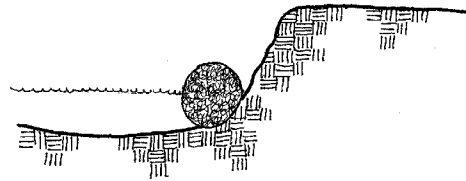


Procedure for Fiberschines

Acquire the amount of fiberschines needed for the project.



Place fiberschine at the toe of streambank at the low water line. Key in the ends of the fiberschine. See "How to Install".

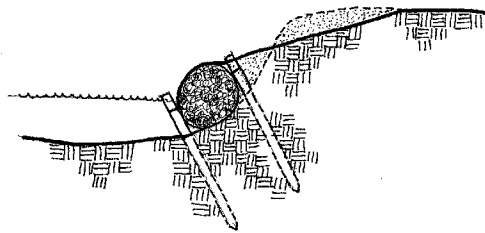
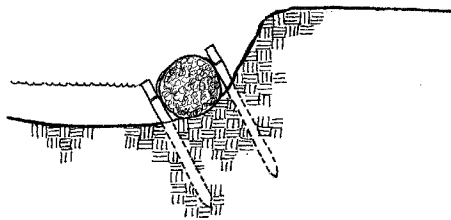


Step One: Acquisition of fiberschines

Step Two: Excavate Trench

Drive notched wooden stakes at 5' intervals on each side of the fiberschine. Tie twine between each pair of notched stakes. Drive stakes in until twine is tight across the top of the fiberschine.

Backfill behind the fiberschine.

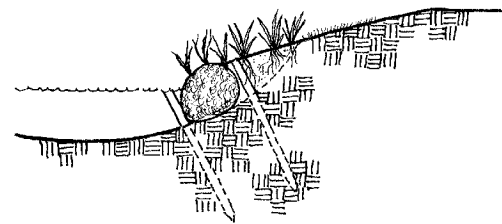
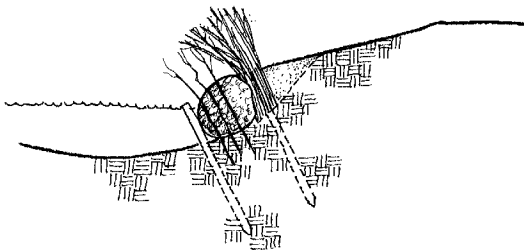


Step Three: Secure fiberschines

Step Four: Backfill

Willow cuttings should be planted into and behind the fiberschine before backfilling.

Herbaceous wetland plants should be planted into the roll and the soil after backfilling. Make sure the root systems are in saturated soil.

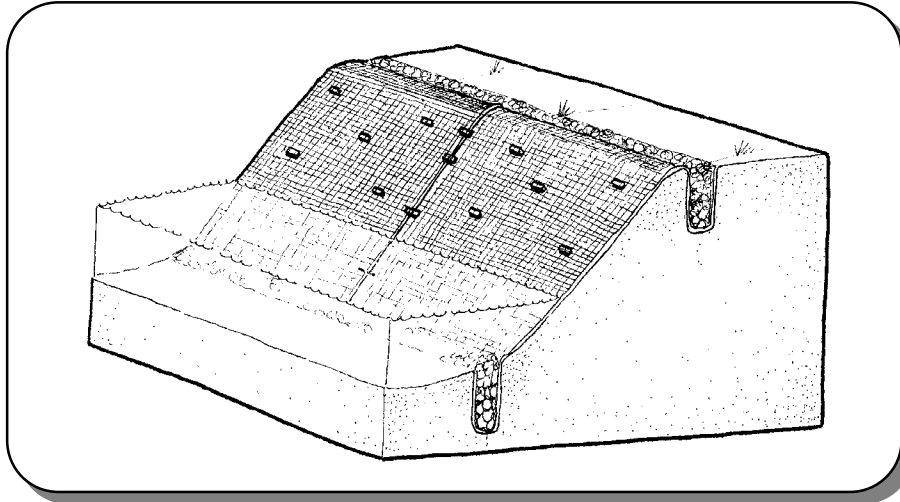


Step 5: Willow Plantings

Step 5: Herbaceous Wetland Plantings



Erosion Control Fabric



Materials:

- o erosion control fabric
- o shovel
- o sledgehammer
- o wedge-shaped wooden stakes
- o 1 person minimum

Description and Use

Erosion control fabrics are commercially-available products that can be used to prevent erosion on slopes until vegetation establishes and has a chance to stabilize the slope. The fabrics are constructed of a variety of materials from coconut fiber or jute to straw mulch encased in plastic netting. For stream applications, a tightly woven coconut fiber blanket is the most durable option. Woody cuttings and herbaceous plants can be planted into the fabric and seed can be placed underneath the fabric. By the time the blanket decomposes (usually 2 to 5 years depending on local climate), vegetation will have significantly stabilized the streambank.

NOTE: Although this technique can be used by itself in a stream system, it is probably best to use this material with other techniques (see page 4).

How To Install

Determine the square footage of the treatment area and acquire the necessary amount of fabric from a supplier. Order extra material to allow for overlap. A list of suppliers can be obtained from the International Erosion Control Association which is listed in the Resource section of this guide.

1. Seed the streambank with native herbaceous seed and rake to ensure good seed-soil contact. Fabrics are most effective on slopes that are no steeper than 2H:1V.

2. Excavate two trenches, one at the toe of the slope and the other at the top of the bank. The trench at the toe should be 12 inches deep and 6 to 8 inches wide. The trench at the top of the bank should be located at least a foot from the edge and should be 12 inches deep and 6 to 8 inches wide.

3. A key trench at the upstream end should be excavated perpendicular to the flow, connecting the ends of the other trenches (See illustrations).

4. The fabric should be placed on the streambank with the ends of the fabric in the trench so that the fabric is touching the three sides of the trench. Use a wedge-shaped wood stake to secure the fabric to the bottom of the trench.

5. Continue to cover the rest of the streambank with the fabric blanket. Install the blankets so the edge overlaps are shingled away from the direction of the current. Overlap the blanket edges approximately 12 inches and secure with wedge-shaped wooden stakes. Secure the blanket to the slope according to manufacturer specifications. Usually, a triangular spacing of 24" on center is suitable for stream applications. The upstream end of the blanket should be keyed into the final trench.

6. Backfill the trenches with excavated soil or small cobble and compact it. Pole plantings should be planted through the fabric (See page 4).

Erosion Control Fabric

Inventory & Planning Considerations

1. An important step with this technique is to ensure the upstream and downstream ends of the erosion control blanket are well keyed into the bank to prevent high flows from pulling the blanket out. Cobble should be placed in the key trenches to prevent the fabric from being pulled out.
2. Another important step is where the fabric overlaps, it should be shingled away from the direction of the current to prevent flows from pulling at the fabric.
3. Never disturb the site unnecessarily. Remember the goal is to stabilize a site. The less it is disturbed, the easier it will be to restore.

Management

To ensure the highest success for the treated area, determine the land management practices that created the eroded streambanks and modify those practices as necessary.

If the area is grazed, restrict livestock from treated areas to allow the eroded section of streambank to heal. Exclosure fences are the most efficient means to accomplish this goal. Managers should resist the temptation to put the exclosure fences at the high water line. The exclosure areas should include enough of the riparian zone to allow the stream to shift naturally over time.

If the area is farmed, a riparian buffer strip should be established and maintained. A buffer strip on both sides of the stream should be set aside to allow for natural riparian vegetation and stream function. A wider buffer strip is strongly encouraged and will yield greater benefits.

Check with your local NRCS district conservationist for cost-share programs and volunteers for fencing, planting, and other restoration activities.

Finally, a stream is an interconnected system and land use practices both upstream and downstream will affect the success of your bioengineering work. Talk with your neighbors and work together to create a healthier riparian and stream system that can benefit everyone.

Monitoring & Maintenance

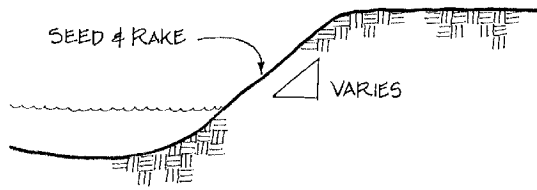
Do not ignore the project after it has been installed. Periodic monitoring of the project will provide valuable insight into the stabilization process and may offer important information for future projects.

Periodic maintenance includes making sure the staples and key trenches are still securing the fabric blanket to the streambank. The upstream end should be carefully checked to make sure flows are not getting behind the blanket.



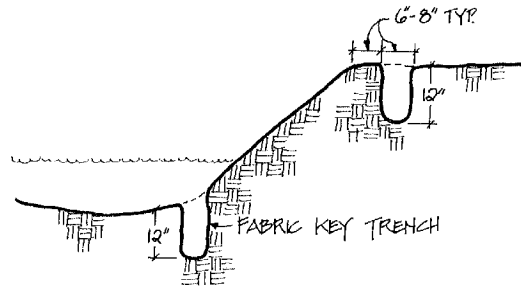
Procedure for Erosion Control Fabric

Seed the streambank with native herbaceous seed and rake in to ensure good seed-soil contact. Slope varies-See "How to Install".



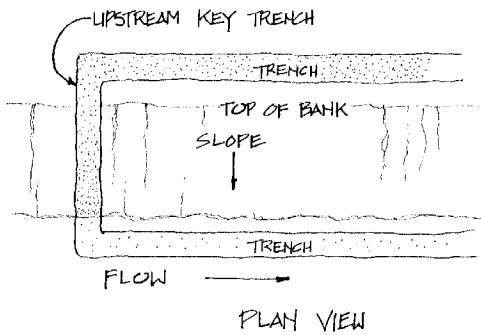
Step One: Seeding

Excavate two trenches as shown.



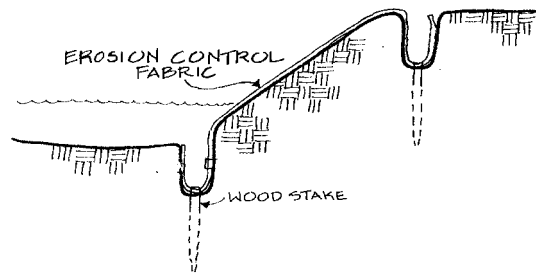
Step Two: Excavate Trench

Excavate an upstream key trench perpendicular to flow.



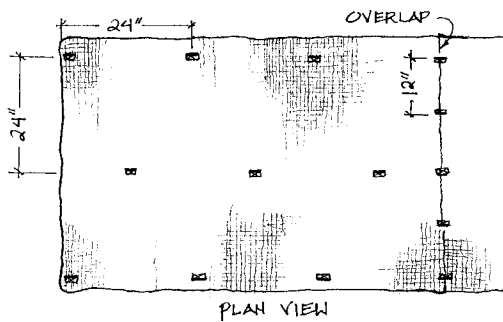
Step Three: Upstream Key Trench

Place fabric on streambank and in trenches and secure with a wedge-shaped wooden stake.



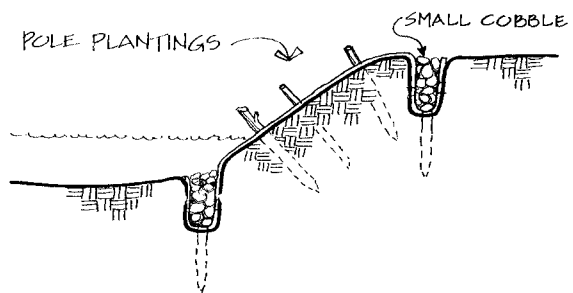
Step Four: Fabric Placement

After laying out the blanket, secure the fabric with wedge-shaped wooden stakes according to manufacturers specs or suggested pattern.



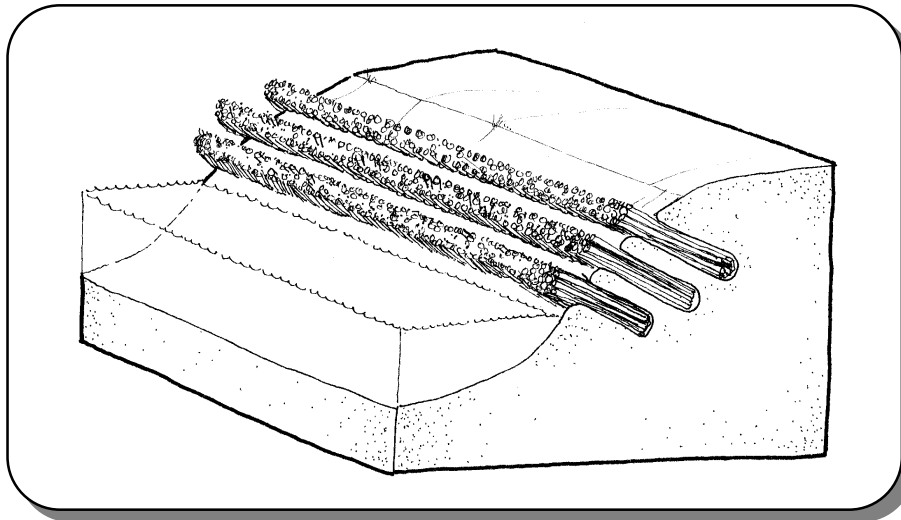
Step Five: Suggested Stake Layout

Backfill all trenches with excavated soil or small cobble and compact it.



Step Six: Backfill

Brush Layering



Materials:

- o willow cuttings
- o clothesline cord or wire
- o chain saw or loppers (to harvest willows)
- o shovel
- o 1 person minimum

Description and Use

This technique uses bundles of willow cuttings (*Salix* spp.) in buried trenches along the slope of an eroding streambank. This willow "terrace" is used to reduce the length of slope of the streambank. The willow cuttings will sprout and take root, thus stabilizing the streambank with a dense matrix of roots. Some toe protection such as a wattle, fiberschine, or rock may be necessary with this technique.

How To Install

1. Harvest willow cuttings from a local, native stand that is in healthy condition taking no more than 2/3 of each plant. Cuttings should be at least a 1/2 inch diameter or larger to ensure an adequate supply of stored energy for rooting, but there should be a good mixture of various sizes. This is to ensure better entrapment of sediment which will promote better root growth.

Ideally, cuttings should be collected during the dormant season to ensure the highest success rate. Cuttings can be collected during the growing season if all the leaves are removed from the stem, although establishment success will be lowered. Spring plantings are more successful than fall plantings.

2. The cuttings may be tied into bundles to facilitate transportation to the project site. The terminal bud should be removed so that stem energy will be re-routed to the lateral buds for more efficient root and stem sprouting.

3. Soak the bundles for 4 to 5 days.

4. Toe protection if needed should be installed prior to excavation. Excavate a horizontal trench into the streambank along the length of the area to be treated. The trench should be located between the annual low and high water levels. The trench should be approximately 2 to 3 feet deep and the back portion must reach the permanent water table. The surface of the trench should be sloped 10 to 20 degrees such that the outside edge is higher than the inside.

5. Cut the twine on the bundles and place the cuttings in the trench. Make sure the basal cut ends reach the back of the trench. Spread the cuttings in the trench until desired thickness is achieved. In general, the thicker and denser the cuttings, the better the technique will work.

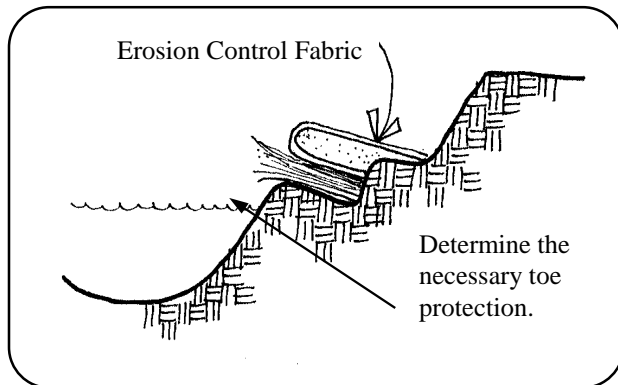
6. Slough the bank down on to the cuttings and pack the soil into the cuttings. To remove air pockets around the cuttings, water the soil when backfilling. The cuttings should extend no more than 12 to 18 inches from the bank to prevent them from being ripped out during high flows. Trim off the excess.

7. Create another terrace for cuttings behind the first layer as shown in the illustrations. Repeat the trenching and layering process until the streambank is sufficiently covered with brush layers. A brush trench can be installed at the top of the bank for overland flows (refer to Brush Trench Technique Sheet).

Brush Layering

Inventory & Planning Considerations

1. Coyote willow (*Salix exigua*) is a particularly good species for this method because of its' dense rooting system. This technique can also be used with a mixture of redbud dogwood (*Cornus sericea*) and willow but to encourage rooting in the dogwood, the stems will need to be manually nicked or cut and treated with rooting hormone.
2. A critical inventory step is to determine the availability of moisture for the cuttings. This technique is best applied to areas with bank seepage to supply enough moisture for the cuttings. In our semi-arid to arid region, the upper portion of the streambank may not have enough permanent moisture to establish the cuttings, and thus, other techniques may be required.
3. Another critical step with this technique is to determine if toe protection is necessary. Analysis and calculations will provide some guidance (see Chapter 3 Streambank Bioengineering Guide). In many cases rock will be necessary to provide adequate protection. In addition to toe protection, erosion control fabric can be used to protect the soil



Brush Layering with Erosion Control Fabric

4. Give careful attention to the upstream and downstream ends of the treatment area to prevent flows from getting behind the layers. Tying into existing features on site such as trees and rocks or the additional placement of brush and rocks are possible solutions.

Management

To ensure the highest success for the treated area, determine the land management practices that created the eroded streambanks and modify those practices as necessary.

If the area is grazed, restrict livestock from treated areas to allow the eroded section of streambank to heal. Exclosure fences are the most efficient means to accomplish this goal. Managers should resist the temptation to put the exclosure fences at the high water line. The exclosure areas should include enough of the riparian zone to allow the stream to shift naturally over time.

If the area is farmed, a riparian buffer strip should be established and maintained. A buffer strip on both sides of the stream should be set aside to allow for natural riparian vegetation and stream function. A wider buffer strip is strongly encouraged and will yield greater benefits.

Check with your local NRCS district conservationist for cost-share programs and volunteers for fencing, planting, and other restoration activities.

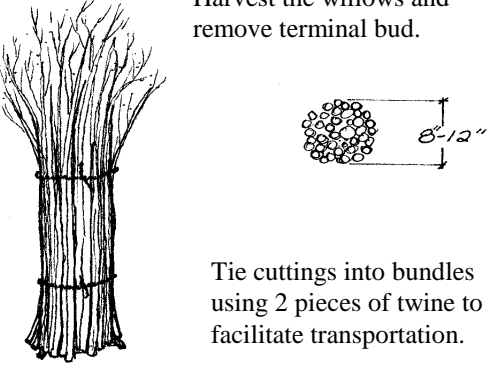
Finally, a stream is an interconnected system and land use practices both upstream and downstream will affect the success of your bioengineering work. Talk with your neighbors and work together to create a healthier riparian and stream system that can benefit everyone.

Monitoring & Maintenance

Do not ignore the project after it has been installed. Periodic monitoring of the project will provide valuable insight into the stabilization process and may offer important information for future projects.

Periodic maintenance includes making sure the streambank is not eroding close to the side of the trench. It may be determined that some additional protection is necessary to allow more time for the cuttings to take root and stabilize the streambank.

Procedure for Brush Layer



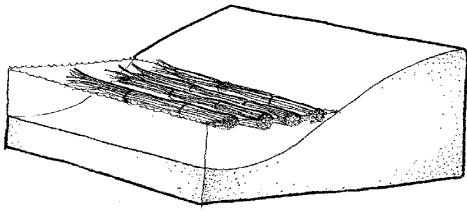
Harvest the willows and remove terminal bud.

Tie cuttings into bundles using 2 pieces of twine to facilitate transportation.

8-12"

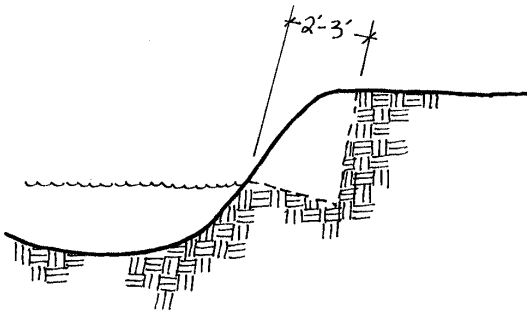
Step One: Acquire Willow

Soak the bundles for 5 to 7 days before planting. Remove from water before roots emerge.



Step Two: Soak Willow Bundles

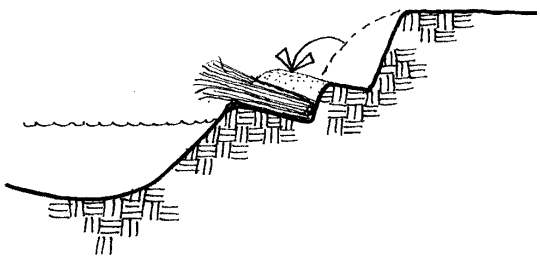
Install the selected toe protection. Excavate the trench and make sure the trench slopes back.



2-3'

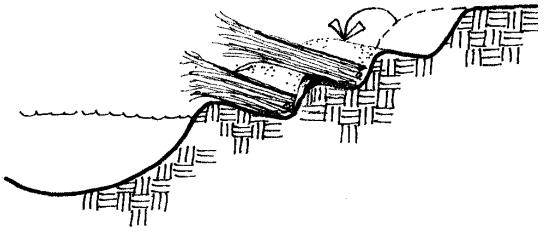
Step Three: Excavate trench

Lay out the cuttings along the trench and slough the bank onto the cuttings. Work the soils into the cuttings.



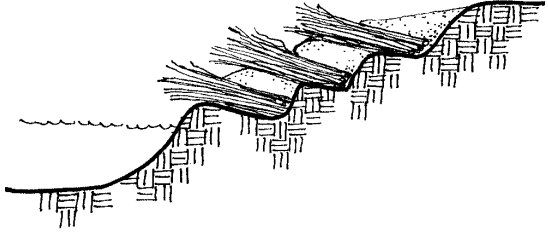
Step Four: Layer Placement

Create another terrace as shown and place the cuttings. Slough the bank on to the cuttings.



Step Five: 2nd Layer Placement

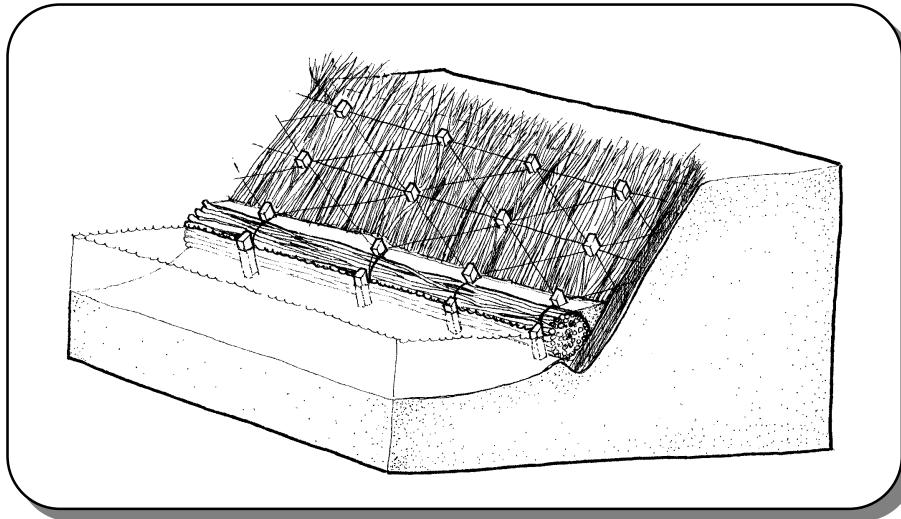
Repeat the process until the final layer is placed.



Step Six: 3rd Layer Placement



Brush Mattress



Materials:

- o willow cuttings
- o clothesline cord or wire
- o chain saw or loppers (to harvest willows)
- o shovel
- o 10-12 gauge wire
- o wood stakes
- o 2 person minimum

Description and Use

This technique uses a mat of willow cuttings along the slope of an eroding streambank. The cut ends of the willows are placed in a trench at the toe of the slope and are anchored with a wattle (See other Technique Sheet). A grid of wire and wooden stakes is used to secure the mat to the slope. The willow cuttings will sprout and take root, thus stabilizing the streambank with a dense matrix of roots.

How To Install

See Willow Wattle/Fascine Technique Sheet for information on collecting willow cuttings for the wattle and brush mattress.

1. Prepare the slope of the streambank by clearing away large debris, however, do not remove woody debris from the stream channel because this provides important fish habitat. The brush mattress technique is probably most effective on slopes no steeper than 2H:1V. Excavate a horizontal trench, 8 to 12 inches deep, at the toe of the streambank along the length of the area to be treated.
2. Place willow cuttings in the trench. Make sure the cut ends reach the bottom of the trench. Spread the cuttings along the face of the slope until a thickness of 4 to 6 inches is achieved.
3. Pound in a grid of 24 to 36 inch long wooden stakes into the mattress every 3 to 4 foot centers

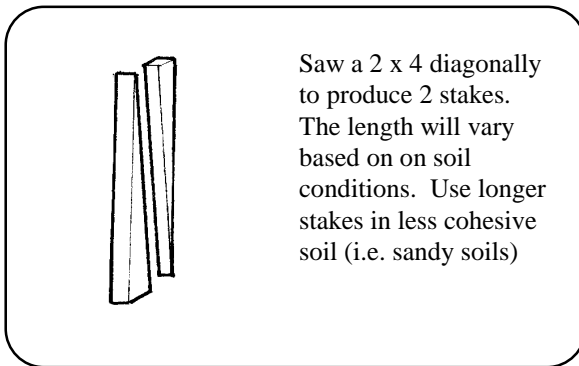
(See illustrated procedure). Use longer stakes in less cohesive soil. Secure the brush mattress by using 10-12 gauge galvanized annealed wire or clothesline cord tied in horizontal runs and then diagonally between each row of stakes. Tie the wire to the stakes in such a manner that if the wire breaks between two stakes, the integrity of the remaining wiring is maintained.

4. After wiring the mattress, drive the stakes in further to compress the mattress tightly against the streambank.
5. Construct a wattle the length of the area to be treated (refer to Willow Wattle Technique Sheet). Make sure the wattle is tightly tied together. Place the wattle in the trench over the cut ends of the brush mattress. Secure the wattle with 18 to 48 inch long wedge-shaped wooden stakes every 5 feet as shown the illustrated sequence. Use longer stakes in less cohesive soil. In some instances, a rock toe may be used instead of a willow wattle to anchor the cut ends of the mattress.
6. Backfill around the wattle and mattress by using material excavated from the trench, making sure to work soil into the branches. Use buckets of water to wash the soil down into the stems. Key the upstream end of the mattress and wattle into the streambank to prevent high flows from getting behind the mattress. It is a good idea to protect this area with some revetment, large rocks, or tree trunks.

Brush Mattress

Inventory & Planning Considerations

1. Make sure the upstream end of the wattle and mattress is keyed back into the bank to prevent high flows from scouring behind the mattress. Brush revetment, rock barbs, large rocks, and tree trunks can be used in front of this area to protect the mattress.
2. Be sure to pound in the stakes after wiring the mattress in order to compress the mattress tightly against the streambank.
3. Coyote willow (*Salix exigua*) is a particularly good species for this method because of its' dense rooting system.
4. Rooting hormones and fertilizers do not significantly improved success compared to the cost of the materials.
5. Never disturb the site unnecessarily. Remember the goal is to stabilize a site. The less it is disturbed,



the easier it will be to restore.

Management

To ensure the highest success for the treated area, determine the land management practices that created the eroded streambanks and modify those practices as necessary.

If the area is grazed, restrict livestock from treated areas to allow the eroded section of streambank to heal. Exclosure fences are the most efficient means to accomplish this goal. Managers should resist the temptation to put the exclosure fences at the high water line. The exclosure area should include enough of the riparian zone to allow the stream to shift naturally over time.

If the area is farmed, a riparian buffer strip should be established and maintained. A buffer strip on both sides of the stream should be set aside to allow for natural riparian vegetation and stream function. A wider buffer strip is strongly encouraged and will yield greater benefits.

Check with your local NRCS district conservationist for cost-share programs and volunteers for fencing, planting, and other restoration activities.

Finally, a stream is an interconnected system. Land use practices both upstream and downstream will affect the success of your bioengineering work. Talk with your neighbors and work together to create a healthier riparian and stream system that can benefit everyone.

Monitoring & Maintenance

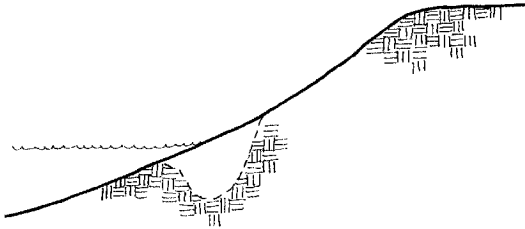
It is important to monitor the project after it has been installed. Periodic monitoring of the project will provide valuable insight into the stabilization process and may offer important information for future projects.

Periodic maintenance includes making sure the stakes and wire are still securing the mattress to the streambank. The upstream end should be carefully checked to make sure flows are not getting behind the mattress.



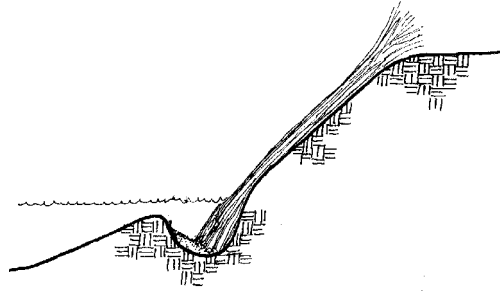
Procedure for Brush Mattress

Willow collection, soaking and wattle construction should occur prior to excavation of the trench. See "How to Install".



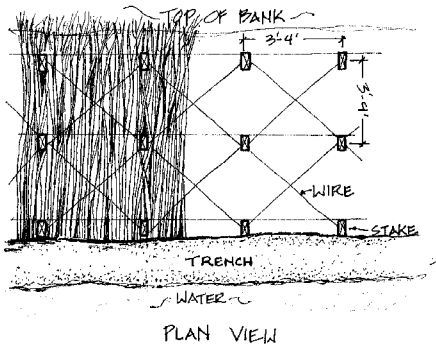
Step One: Excavate Trench

Place willows in the trench, making sure the cut ends reach the bottom.

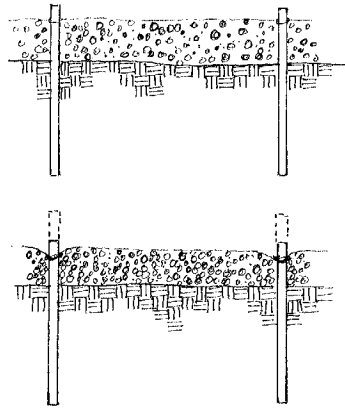


Step Two: Mattress Placement

Establish a grid of wedge-shaped wooden stakes and wire as shown.



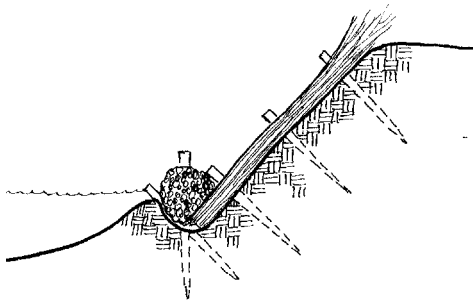
Step Three: Stake Placement and Wiring



After wiring the mattress, drive the stakes in further to compress the mattress against the streambank.

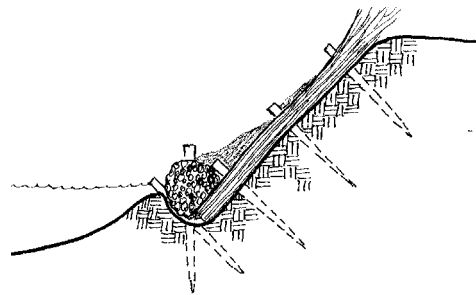
Step Four: Mattress Compression

Place wattle in trench. Secure wattle with 2 wedge-shaped wooden stakes as shown



Step Five: Secure Wattle

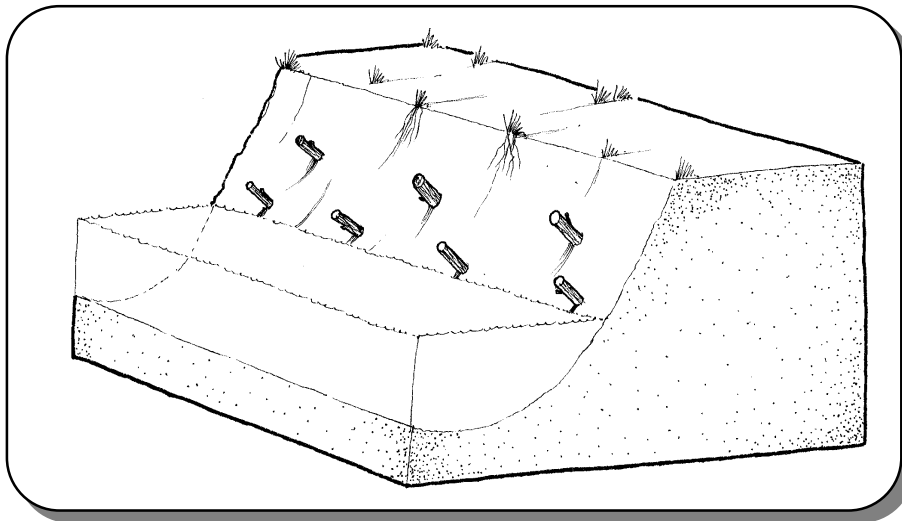
The mattress and wattle should be partially covered with soil, making sure to work the soil into the voids. Leave parts of the blanket exposed for sprouting.



Step Six: Backfill



Pole Plantings



Materials:

- o willow or cottonwood cuttings
- o poly twine
- o chain saw or loppers (to harvest)
- o auger or planting bar
- o 1 person minimum

Description and Use

Pole plantings are cuttings from willow (*Salix* spp.) or cottonwood (*Populus* spp.) used to revegetate eroding streambanks. These cuttings will sprout and take root, stabilizing the streambank with a dense matrix of roots.

How To Install

1. Collect willow or cottonwood cuttings from a local, native stand that is in healthy condition. Thin no more than 2/3 of each total plant. Willow cuttings for pole plantings should generally be at least 1/2 inch in diameter or larger, depending upon the species.

Larger diameter cuttings have a greater supply of stored energy for rooting than smaller diameter cuttings. Bigger diameter and longer lengths are better suited for severely eroded areas and fluctuating water levels.

Ideally, cuttings should be collected during the dormant season to ensure the highest success rate. Cuttings can be collected during the growing season if all the leaves are removed from the stem, although establishment success will be lowered. Spring plantings are generally more successful than fall plantings.

2. Prepare cuttings by trimming off the top to remove the terminal bud, allowing a majority of the

energy in the stem to be sent to the lateral buds for rooting and sprouting.

3. The cuttings can be tied into bundles for ease of transportation to the site.

4. Soak the bundles for 5 to 7 days. Cutting length is determined by site conditions. The cutting should extend several inches into the permanent water table to ensure adequate moisture for sprouting. At least 1/2 to 2/3's of the cutting should be below ground to prevent the cutting from being ripped out during high flows. Usually, at least 2 to 3 feet should be below ground. It should also be long enough to emerge above adjacent vegetation such that it will not be shaded out.

5. Pole plantings are usually planted with a power auger or a punch bar. It is critical to ensure the soil is packed around the cutting to prevent air pockets. "Mudding" (filling the hole with water and then adding soil to make a mud slurry) can remove air pockets.

6. It is often advisable to plant at least two rows of cuttings to cover the range in fluctuating water levels. The location of the cuttings will depend on the specific situation and hydrograph. In some cases where information is limited, one row can be planted at the low flow line and the other at the high flow line. Offset the rows to get better coverage (see illustration).

Pole Plantings

Inventory & Planning Considerations

1. Shrub willows such as coyote willow (*Salix exigua*) are used for planting within channel banks. Willow tree species and cottonwoods are normally planted along the upper bank and floodplain areas. Tree species usually provide more shade.
2. If this method is used in a highly erodible area, some protection will be required in front of the pole plantings. In particular, the toe of the slope is very susceptible to erosive flows and scour. Analysis and calculations of forces will provide guidance for suitable toe protection (refer to Chapter 3 of the Streambank Bioengineering Guide). In some cases, brush revetment or fiber rolls may be adequate (see other Technique Sheets), while other situations may require rock. If rock is used, careful application is required. Improperly placed rock can result in erosion problems on the opposite streambank as well as downstream.
3. As with all techniques, give careful attention to the upstream and downstream ends of the treatment area to prevent flows from getting behind the treatment. The key is to divert flows away from these endpoints. Tying into existing on site features such as trees, rocks, etc., or using brush revetment and rock barbs are some possible solutions.
4. It is important that the cuttings be placed in water immediately following harvesting if they are going to be planted during the next week. The cuttings can also be kept in cold storage (32 to 35° F) for up to 6 months. After removal from cold storage, soak the cuttings for 5 to 7 days prior to planting.
5. Rooting hormones and fertilizers do not significantly improved success compared to the cost of the materials.
6. Cuttings will often require initial protection from beaver. Fine wire screen or mesh can be secured around the cuttings to offer protection.
7. Never disturb the site unnecessarily. Remember the goal is to stabilize a site. The less it is disturbed, the easier it will be to restore.

Management

To ensure the highest success for the treated area, determine the land management practices that created the eroded streambanks and modify those practices as necessary.

If the area is grazed, restrict livestock from treated areas to allow the eroded section of streambank to heal. Exclosure fences are the most efficient means to accomplish this goal. Managers should resist the temptation to put the exclosure fences at the high water line. The exclosure areas should include enough of the riparian zone to allow the stream to shift naturally over time.

If the area is farmed, a riparian buffer strip should be established and maintained. A buffer strip on both sides of the stream should be set aside to allow for natural riparian vegetation and stream function. A wider buffer strip is strongly encouraged and will yield greater benefits.

Check with your local NRCS district conservationist for cost-share programs and volunteers for fencing, planting, and other restoration activities.

Finally, a stream is an interconnected system. Land use practices both upstream and downstream will affect the success of your bioengineering work. Talk with your neighbors and work together to create a healthier riparian and stream system that can benefit everyone.

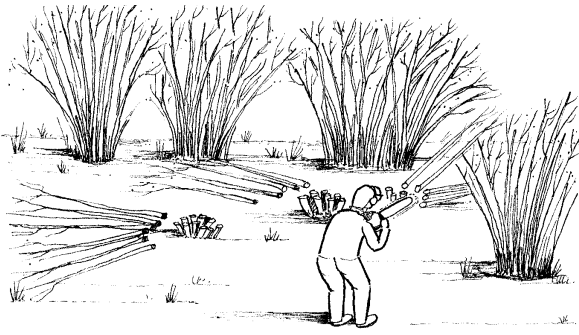
Monitoring & Maintenance

Do not ignore the project after it has been installed. Periodic monitoring of the project will provide valuable insight into the stabilization process and may offer important information for future projects.

Replanting will probably be necessary to fill in areas where plantings did not grow. It is not uncommon to have some cuttings die due to highly variable water flows from year to year or from wildlife predation. Flood debris lodged around the cuttings should be removed to prevent shading and to allow growth.

Procedure for Pole Plantings

Pole cuttings can be collected from large willows and cottonwoods.



Trim off all side and terminal branches



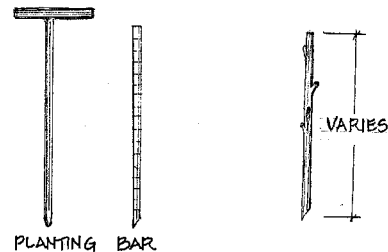
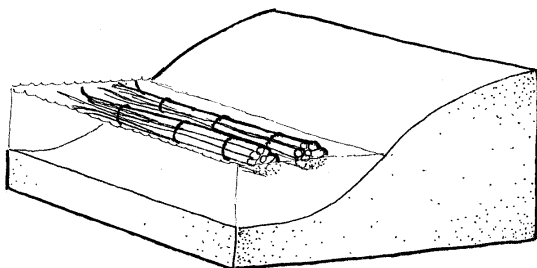
Tie cuttings into 8-12" diameter bundles using 2 pieces of twine to facilitate transportation.

Step One: Harvest Willow Cuttings

Step Two: Create Willow Bundles

Soak bundles for 5 to 7 days. Remove them from water before roots emerge.

Final cutting length will vary (See "How to Install"). Punch bars or augers can be used for creating the holes.

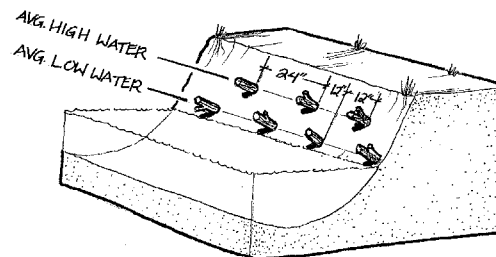
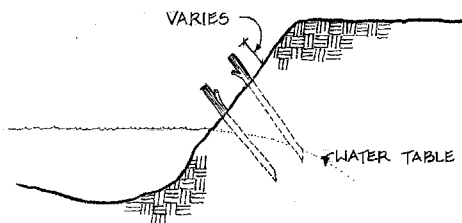


Step Three: Soak Willow Bundles

Step Four: Planting Preparation

Plant the pole such that the end of the cuttings extends into the water table. Above ground height varies (See "How to Install").

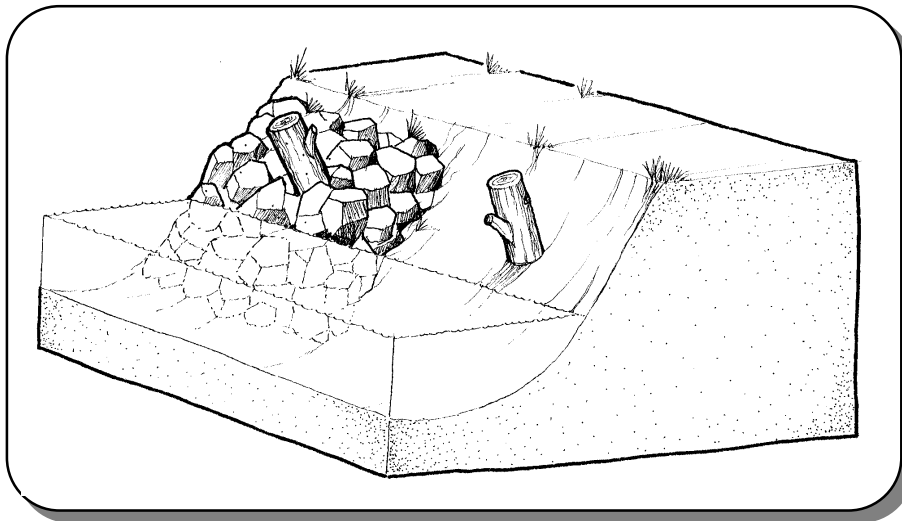
The following is a good spacing pattern to cover the variables of a fluctuating water level.



Step Five: Pole Planting

Step Six: Pole Placement

Post Plantings



Materials:

- o cottonwood or willow posts
- o metal cap (for pushing in posts)
- o chain saw
- o stinger & backhoe
- o 2 person minimum

Description and Use

Post plantings use large diameter cuttings from cottonwood (*Populus spp.*) or willow (*Salix spp.*) to revegetate eroding streambanks and reservoir and lake edges. By using a stinger, posts may be planted into existing rip-rap. A stinger is a large metal punch bar mounted on a backhoe. These cuttings will sprout and take root, thus stabilizing the streambank with a dense matrix of roots.

Instructions for building a stinger can be obtained from:

USDA-NRCS Plant Materials Center
Box 296
Aberdeen, ID 83210
(208) 397-4133

How To Install

1. Harvest cottonwood or willow posts from a local, native stand that is in healthy condition. Harvest only a few posts from each plant. Posts should be collected during the dormant season to ensure the highest success rate. Posts can be collected during the growing season if all leaves are removed from the stem, although establishment success will be lowered. Spring plantings are generally more successful than fall plantings.

2. The posts should range in size from 3 to 6 inches in diameter and 5 to 7 feet in length. Larger diameter cuttings have a greater supply of stored

energy for rooting than smaller diameter cuttings.

Bigger diameters and longer length are better suited for severely eroded areas and fluctuating water levels. Prepare the posts by trimming off all side branches and the top. The bottom can be sharpened into a point to facilitate planting.

3. Soak the posts for 5 to 7 days prior to planting.

4. Take posts and stinger to project area. Punch holes with the stinger at 1 foot above the high waterline. This can be difficult to determine at reservoirs and streams with widely fluctuating water levels from year to year. In this case, ensure that the ends of the posts reach the low waterline at the time of planting if possible. The stinger should be removed slowly from the hole to prevent it from caving in.

5. As the stinger is removed from the hole, a person should be ready to insert a post into the hole immediately. A metal cap should then be placed over the post to protect the cutting as it is being pushed into the hole with the stinger.

6. Remove metal cap. Approximately 3 to 8 inches of the post should be left above ground. Posts can be planted every 3 to 4 feet with the realization that even with a good success rate, every post will not survive to maturity.



Post Plantings

Inventory & Planning Considerations

1. Successful application of this technique requires a good backhoe operator. Creating the holes and pushing in the posts without breaking them demands care and skill with the backhoe controls.
2. If this method is used in a highly erodible area that is not already rip-rapped, some protection should be placed in front of the post plantings. In particular, the toe of the slope is very susceptible to erosive flows and scour. Analysis and calculations of forces will provide guidance for suitable toe protection (refer to Chapter 3 Streambank Bioengineering Guide). In some cases, brush revetment or fiber rolls may be adequate (See other Technique Sheets), while other situations may require rock. If rock is used, careful application is required. Improperly placed rock can result in erosion problems on the opposite streambank as well as downstream.
3. As with all techniques, give careful attention to the upstream and downstream ends of the treatment area to ensure flows do not get behind the treatment. The key is to divert flows away from these endpoints. Tying into existing on site features such as trees, rocks, etc. or using brush revetment are some possible solutions.
4. It is important the posts be placed in water immediately following harvesting if they are going to be planted during the next week. The cuttings can also be kept in cold storage (32 to 35° F) for up to 6 months. After removal from cold storage, soak the cuttings for 5 to 7 days prior to planting.
5. Rooting hormones and fertilizers do not significantly improve success compared to the cost of the materials unless the bark is heavily furrowed.
6. Cuttings will often require initial protection from beaver. Fine wire screen or mesh can be secured around the cuttings to offer protection.
7. Never disturb the site unnecessarily. Remember the goal is to stabilize a site. The less it is disturbed, the easier it will be to restore.

Management

To ensure the highest success for treated area, determine the land management practices that created the eroded streambanks and modify those practices as necessary.

If the area is grazed, restrict livestock from treated areas to allow the eroded section of streambank to heal. Exclosure fences are the most efficient means to accomplish this goal. Managers should resist the temptation to put exclosure fences at the high water line. The exclosure areas should include enough of the riparian zone to allow the stream to shift naturally over time.

If the area is farmed, a riparian buffer strip should be established and maintained. A buffer strip on both sides of the stream should be set aside to allow for natural riparian vegetation and function. A wider buffer strip is strongly encouraged and will yield greater benefits.

Check with your local NRCS district conservationist for cost-share programs and volunteers for fencing, planting, and other restoration activities.

Finally, a stream is an interconnected system. Land use practices both upstream and downstream will affect the success of your bioengineering work. Talk with your neighbors and work together to create a healthier riparian and stream system that can benefit everyone.

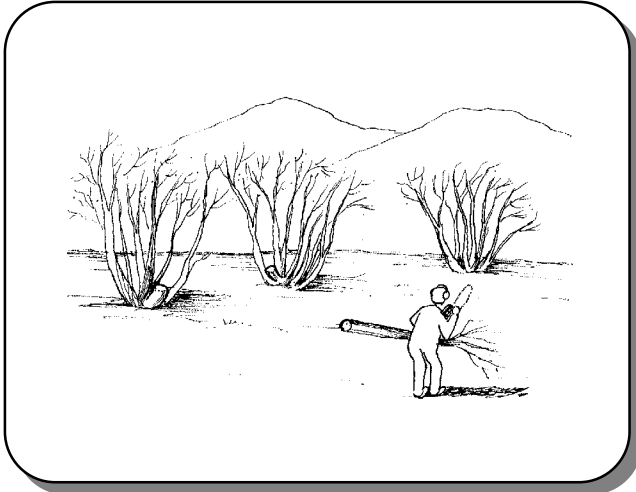
Monitoring & Maintenance

Do not ignore the project after it has been installed. Periodic monitoring of the project will provide valuable insight into the stabilization process and may offer important information for future projects.

Replanting will probably be necessary to fill in areas where plantings did not grow. It is not uncommon to have some cuttings die due to highly variable water flows from year to year or from wildlife predation. Flood debris lodged around the posts should be removed to prevent shading and to allow growth.

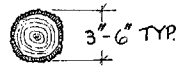


Procedure for Post Plantings

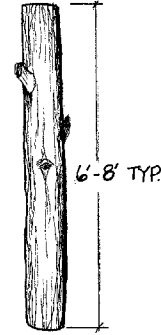


Step One: Harvest Posts

Prepare posts by trimming off side branches

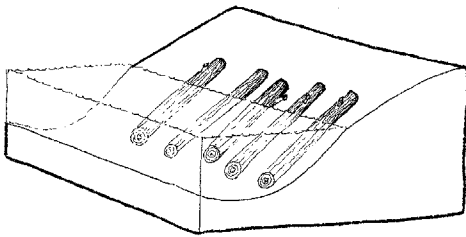


Posts may be longer based on site conditions.



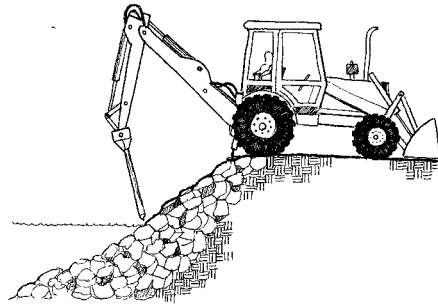
Step Two: Post Specifications

Soak posts for 5 to 7 days. Remove them from the water before roots emerge.



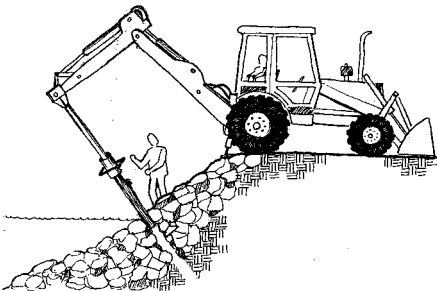
Step Three: Soak Posts

Punch hole with stinger at average water line.

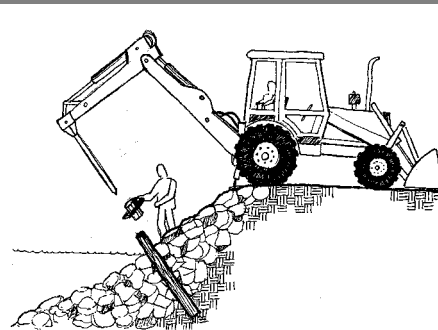


Step Four: Punch Hole

Place a metal cap over the post, then push the post into the hole until 12 to 18 inches extend above the rip-rap.

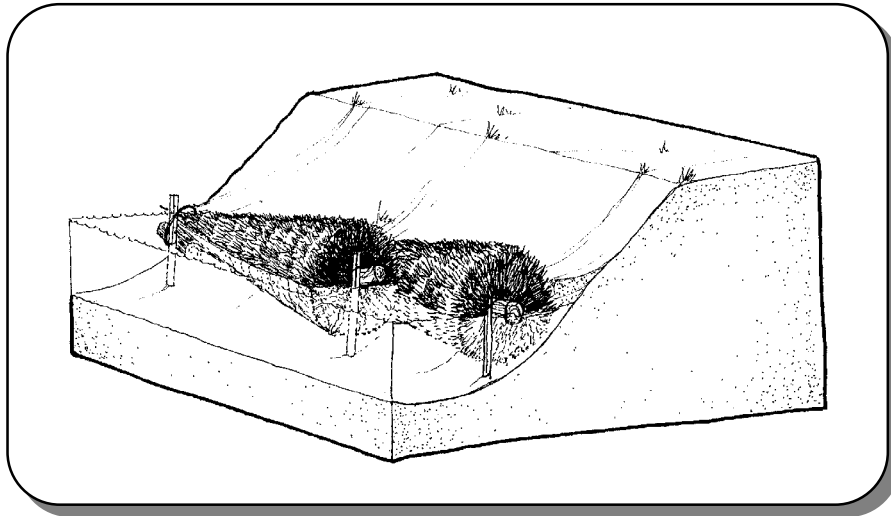


Step Five: Post Placement



Step Six: Remove Metal Cap

Brush or Tree Revetment



Materials:

- o dead/live brush or trees such as junipers or hawthorns
- o 10-12 gauge wire
- o poly rope
- o 7-1/2' metal t-posts
- o wire cutters
- o post pounder
- o chain saw (for cutting brush)
- o 2 people minimum

Description and Use

Brush or trees are secured to the streambanks slow excessive erosion by diverting the current away from the bank edge's. The revetment also traps sediment from the stream and sloughing streambank and provides overhead cover for fish habitat. The revetment material does not need to sprout (most species used will not). Always plant live willows or other quickly sprouting species behind the revetment to provide permanent cover and roots.

How To Install

1. Collect trees or brush and stage at treatment area. Use trees with dense branching such as junipers, because they will collect more sediment. Place the first tree with the stump pointing upstream at the top of the treatment area along the top of the bank. Overlap the next tree trunk into the main branches of the first one. Continue this process until a linear row of brush the length of the treatment area is created.
2. Secure the revetment together by tightly wiring at the overlap sections. Overlap by about 1/3 at each end. Wire main trunks together, leaving branches loose.
3. Pound temporary t-posts along the top of the streambank behind the revetment every 12 to 15 feet. At each post, tie an 8 to 10 foot section of rope

to the revetment and wrap it around the post.

4. Pound a permanent t-post at the toe of the slope of the streambank at the upstream end of the treatment area. Lower the upper end of the revetment and secure it to the post in stream with wire.
5. Lever the revetment into the stream, while using the rope at each of the posts to control placement and to secure it temporarily. Continue the process until revetment is placed along the streambank.
6. Pound t-posts on the outside edge (stream side) of the revetment at overlap areas. Secure the revetment to posts with wire. Remove rope and temporary posts on the top of the streambank.
7. Fill in the space between the streambank and revetment with additional branches or wattles to form a dense matrix of brush.
8. (Optional) To enhance recovery of treated area, knock down the sloughing streambank on the revetment to create a more gentle streambank slope. Make sure the revetment has enough brush material to catch the soil. If not, add additional brush before shaping the bank. Willow cuttings or other quickly sprouting species should then be planted on the new slope using techniques such as willow wattles, brush mattress, vertical bundles, or willow pole plantings (see other Technique Sheets).

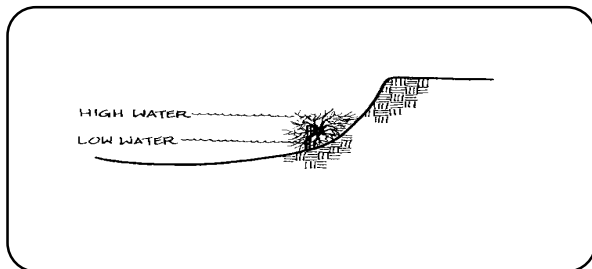
NOTE: Illustrated procedure is shown on page 3. Revetment can be constructed in the water by permanently installing one tree at a



Brush or Tree Revetment

Inventory & Planning Considerations

1. Installation of brush or tree revetment can usually be accomplished throughout the year. For safety reasons, avoid high water periods.
2. Typically, the trunks of the revetment should be placed between the annual low and high water levels.
In areas of extreme fluctuation in water levels, it may be necessary to place a second row of revetment at the high water line in order to prevent scouring behind the revetment during flood events.
3. It is critical that the revetment extend upstream and downstream at least 1 to 3 tree lengths past the eroded area being treated to prevent flows from getting behind the revetment. Key the upstream and downstream ends of the revetment into the bank and reinforced with additional brush or rock. These endpoints are the sections most likely to fail and require substantial protection.



REVETMENT LOCATION

4. Never disturb the site unnecessarily. Remember that the goal is to stabilize a site. The less it is disturbed, the easier it will be to restore.

Management

To ensure the highest success for the treated areas, determine the land management practices that created the eroded streambanks and modify those land use practices as necessary.

If the area is grazed, restrict livestock from treated areas to allow the eroded section of streambank to heal. Exclosure fences are the most efficient means to accomplish this goal. Managers should resist the temptation to put exclosure fences at the high water line. The exclosure areas should include enough of the riparian zone to allow the stream to shift naturally over time.

If the area is farmed, a riparian buffer strip should be established and maintained. A buffer strip on both sides of the stream should be set aside to allow for natural riparian vegetation and stream function. A wider buffer strip is strongly encouraged and will yield greater benefits for the streambanks and the riparian area as a whole.

Check with your local NRCS district conservationist for cost-share programs, volunteers for fencing, planting, and other restoration activities.

Finally, a stream is an interconnected system. Land use practices both upstream and downstream will affect the success of your bioengineering work. Talk with your neighbors and work together to create a healthier riparian and stream system that will benefit everyone.

Monitoring & Maintenance

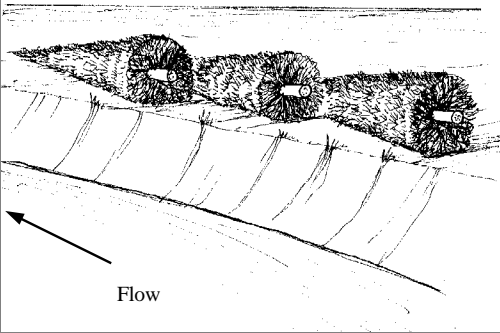
Do not ignore the project after it has been installed. Periodic monitoring of the project will provide valuable insight into the stabilization process and may offer important information for future projects.

Periodic maintenance for brush or tree revetment includes checking the revetment to ensure that the posts and wire are holding it in place. If significant erosion is still occurring in sections of the treated area, additional brush should be added to the revetment.

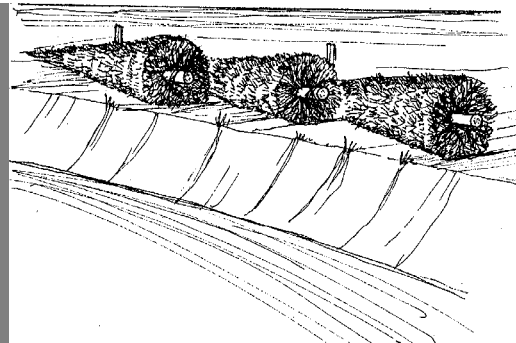


Procedure for Brush or Tree Revetment-Option A

Overlap the trunk of one tree into the main branches of the next tree.



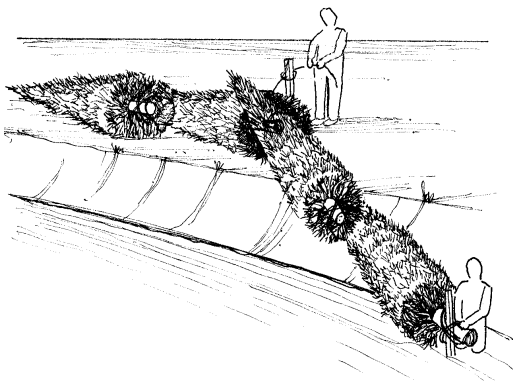
Secure the trees together at the main trunks using wire. Place t-posts along the revetment and secure rope from the posts to the revetment



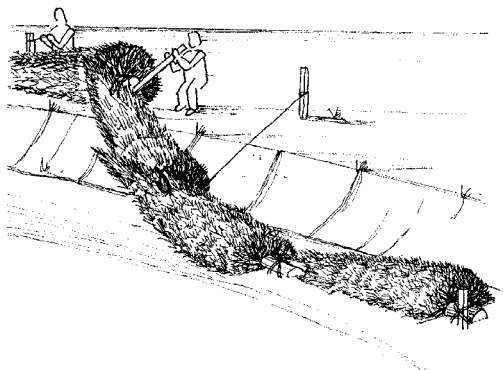
Step One: Harvest & Stage Material

Step Two: Fastening Revetment

Lower revetment into stream and fasten end of revetment to a t-post placed at toe of bank.



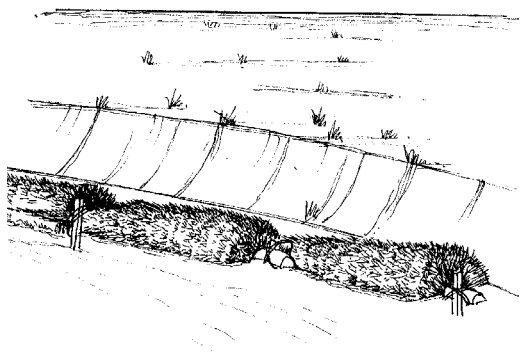
Lever the rest of the revetment into the stream, temporarily securing the revetment to the t-posts.



Step Three: Begin Placement

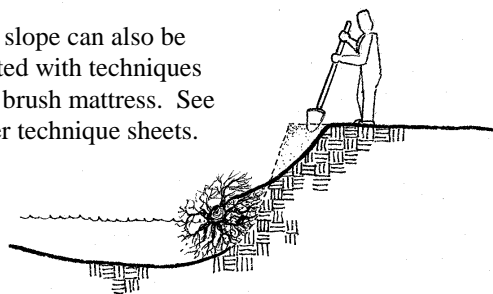
Step Four: Final Placement

Pound t-posts next to the revetment and secure revetment to posts with wire.



Streambank can be knocked down on to the revetment. Slope should be seeded with grass and planted with willows.

The slope can also be treated with techniques like brush mattress. See other technique sheets.

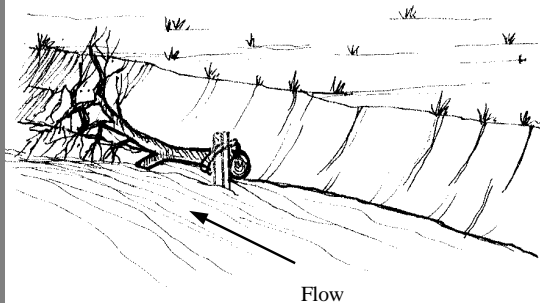


Step Five: Final T-post Placement

Step Six: Optional Bank Shaping

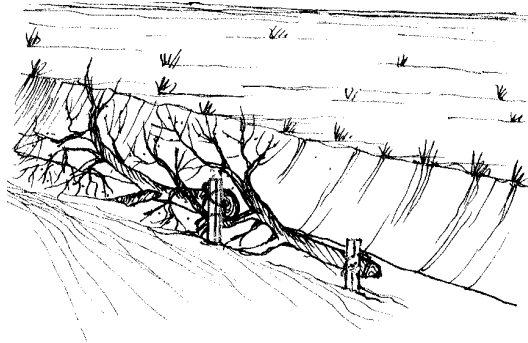
Procedure for Brush or Tree Revetment-Option B

Pound a t-post at the downstream end and secure the trunk of the first tree to the post using wire.



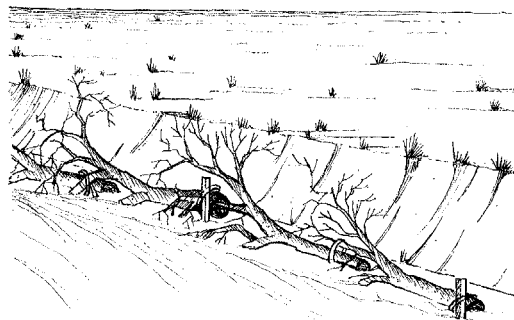
Step One: Placement of First Tree

Overlap the second tree onto the first tree so that no large gaps exist. Wire the trunks together.



Step Two: Placement of Second Tree

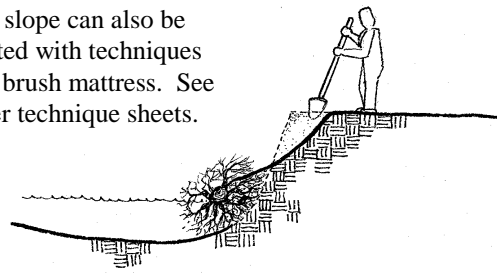
Pound a t-post near the second tree and secure tree to post. Continue placement of trees and posts till area is treated.



Step Three: Continue Placement

Streambank can be knocked down on to the revetment. Slope should be seeded with grass and planted with willows.

The slope can also be treated with techniques like brush mattress. See other technique sheets.



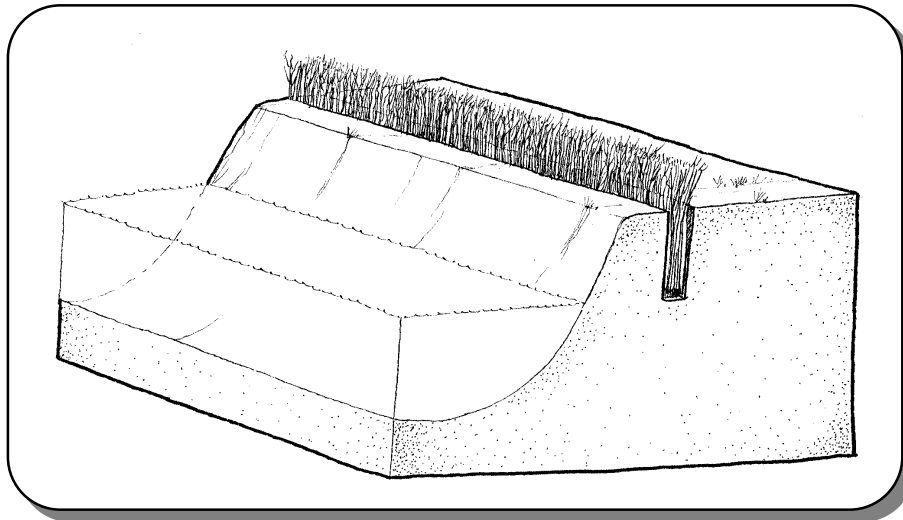
Step Four: Optional Bank Shaping

How To Install

1. Harvest the trees for the revetment and stage near site. Pound a t-post at the downstream end of the site. Secure the first tree to the post with the trunk pointing upstream.
2. Place the second tree so the branches overlap the trunk of the first tree. The goal is to provide for a continuous row of dense branches to protect the streambank. Wire the main trunks together, leaving the branches loose. Pound in another t-post to secure the trunk of the second tree.

3. Continue the process of placing and securing trees until area is treated. Fill in the space between the bank and the revetment with branches to create a dense matrix of brush or willow wattles.
4. (Optional) To enhance recovery of the treated area, knock down the sloughing streambank on to the revetment to create a more gentle streambank slope. Plant willow cuttings on the new slope using techniques such as willow wattles, vertical bundles or willow pole plantings (see other Technique Sheets).

Brush Trench



Materials:

- o willow cuttings
- o clothesline cord or wire
- o chain saw or loppers (to harvest willows)
- o shovel or pick-ax
- o 1 person minimum

Description and Use

This technique uses bundles of willow cuttings (*Salix* spp.) in a buried trench along the top of an eroding streambank. This willow "fence" filters runoff before it enters the stream and is a good method for alleviation of piping problems. The willow cuttings will sprout and take root, thus stabilizing the streambank with a dense matrix of roots. This technique should be used in combination with toe and mid-bank protection methods such as wattles, fiberschines, brush revetment, brush mattress, rock., etc. See other Technique sheets.

How To Install

1. Harvest willow cuttings from a local, native stand that is in healthy condition taking no more than 2/3 of each plant.

Cuttings should be at least 1/2 inch in diameter or larger to ensure an adequate supply of stored energy for rooting, but there should be a good mixture of various sizes. This ensures better entrapment of sediment which will promote better root growth.

Ideally, cuttings should be collected during the dormant season to ensure the highest success rate. Cuttings can be collected during the growing season if all the leaves are removed from the stem, although establishment success will be lowered.

2. The cuttings can be tied into bundles to facilitate transportation to the project site. The terminal bud should be removed so that stem energy will be re-routed to the lateral buds for more efficient root and stem sprouting.

3. Soak the bundles for 5 to 7 days prior to planting.

4. Install the toe protection and mid-bank treatments if needed prior to constructing the brush trench. Excavate a 3-4 inch wide trench at the top of the streambank. Locate the trench about 12 inches from the edge of the top of the streambank. The trench should be at least 18 inches in depth. A pick-ax with a broad blade is useful in excavating the trench. Place the excavated material on the upslope side of the trench.

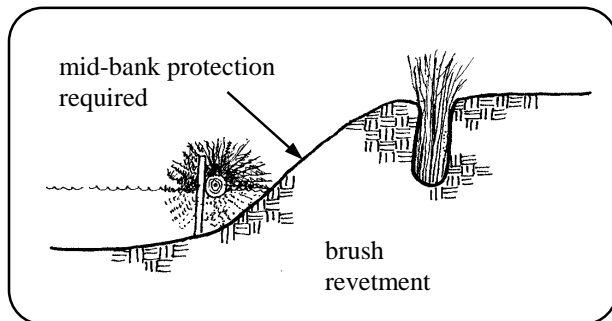
5. Cut the twine on the bundles and place the cuttings in the trench. Make sure the cut ends reach the bottom of the trench. Spread the cuttings in the trench until the desired thickness is achieved. In general, the thicker and denser the cuttings are, the better the technique will work. A good rule of thumb is that one 8 to 12 inch diameter bundle can be spread out over 1 linear foot. The height of the cuttings above ground should extend above the competing ground vegetation.

6. Backfill the trenches with the excavated soil. To remove air pockets around the cuttings, water the soil when backfilling.

Brush Trench

Inventory & Planning Considerations

1. Coyote willow (*Salix exigua*) is a particularly good species for this method because of its' dense root system. This technique can also be used with redbud dogwood (*Cornus spp.*). However, to encourage rooting with dogwoods, the stems need to be manually nicked or cut and treated with rooting hormone.
2. A critical inventory step is to determine the availability of moisture for the cuttings. Either the cuttings will have to reach the capillary fringe of the permanent water table or there will need to be sufficient overland runoff or bank seepage to sustain the willows.
3. Another critical step with this technique is to determine if toe protection is necessary. Analysis and calculations will provide some guidance (see Chapter 3 Streambank Bioengineering Guide). In some cases, brush revetment or fiberschines may be adequate (See other Technique Sheets), while other instances may require rock. In addition to the toe protection, a treatment for the mid-bank may also be needed.



Brush Trench with Brush Revetment

5. Give careful attention to both endpoints of the treatment to prevent flows from getting behind the trench. Tying into existing features on site such as trees or rocks or utilizing additional brush or rock are some possible solutions.
6. Never disturb the site unnecessarily. Remember the goal is to stabilize a site. The less it is disturbed, the easier it will be to restore.

Management

To ensure the highest success for the treated area, determine the land management practices that created the eroded streambanks and modify those practices as necessary.

If the area is grazed, restrict livestock from treated areas to allow the eroded section of streambank to heal. Exclosure fences are the most efficient means to accomplish this goal. Managers should resist the temptation to put the exclosure fences at the high water line. The exclosure areas should include enough of the riparian zone to allow the stream to shift naturally over time.

If the area is farmed, a riparian buffer strip should be established and maintained. A buffer strip on both sides of the stream should be set aside to allow for natural riparian vegetation and stream function. A wider buffer strip is strongly encouraged and will yield greater benefits.

Check with your local NRCS district conservationist for cost-share programs and volunteers for fencing, planting, and other restoration activities.

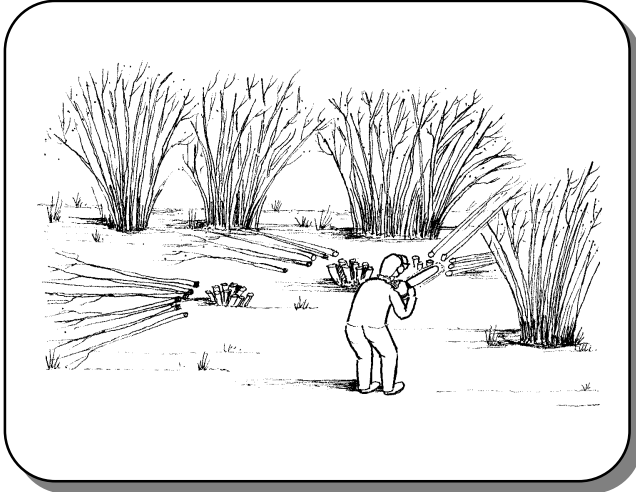
Finally, a stream is an interconnected system and land use practices both upstream and downstream will affect the success of your bioengineering work. Talk with your neighbors and work together to create a healthier riparian and stream system that can benefit everyone.

Monitoring & Maintenance

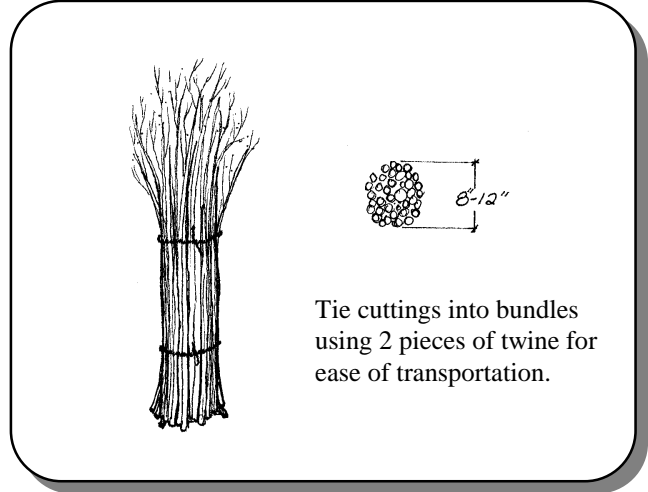
Do not ignore the project after it has been installed. Periodic monitoring of the project will provide valuable insight into the stabilization process and may offer important information for future projects.

Periodic maintenance includes making sure the streambank is not eroding close to the side of the trench. It may be determined that some additional protection is necessary to allow more time for the cuttings to take root and stabilize the streambank.

Procedure for Brush Trench

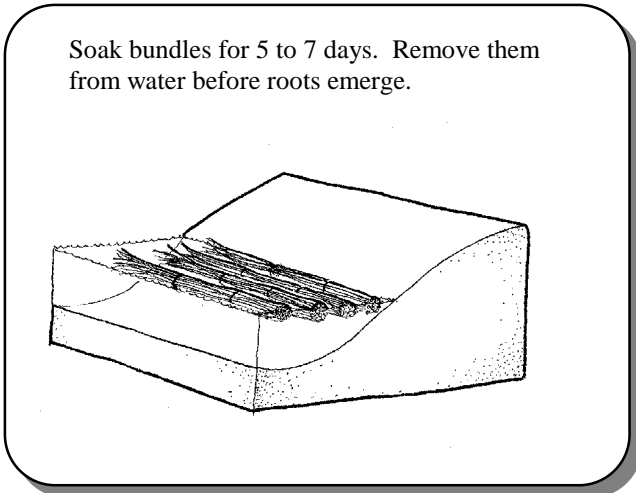


Step One: Harvest Willow Cuttings



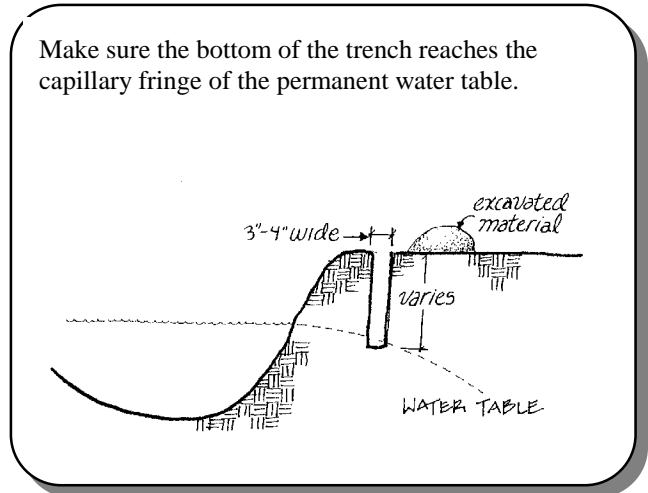
Tie cuttings into bundles using 2 pieces of twine for ease of transportation.

Step Two: Willow Bundles



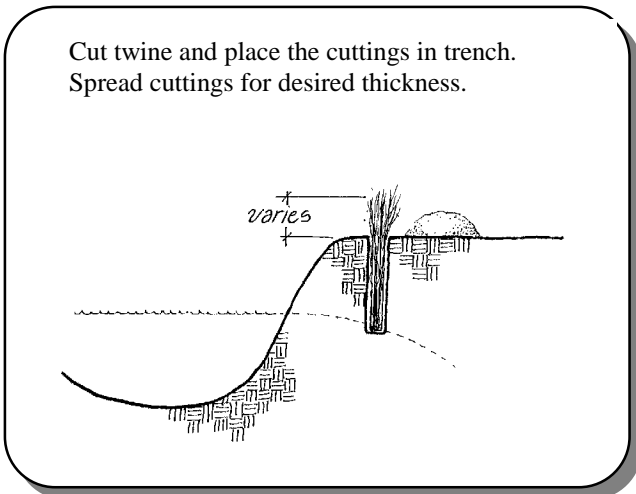
Soak bundles for 5 to 7 days. Remove them from water before roots emerge.

Step Three: Soak Willow Bundles



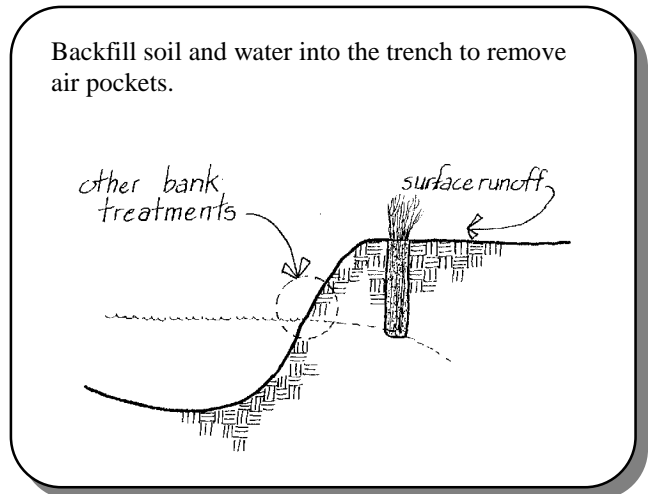
Make sure the bottom of the trench reaches the capillary fringe of the permanent water table.

Step Four: Excavate Trench



Cut twine and place the cuttings in trench. Spread cuttings for desired thickness.

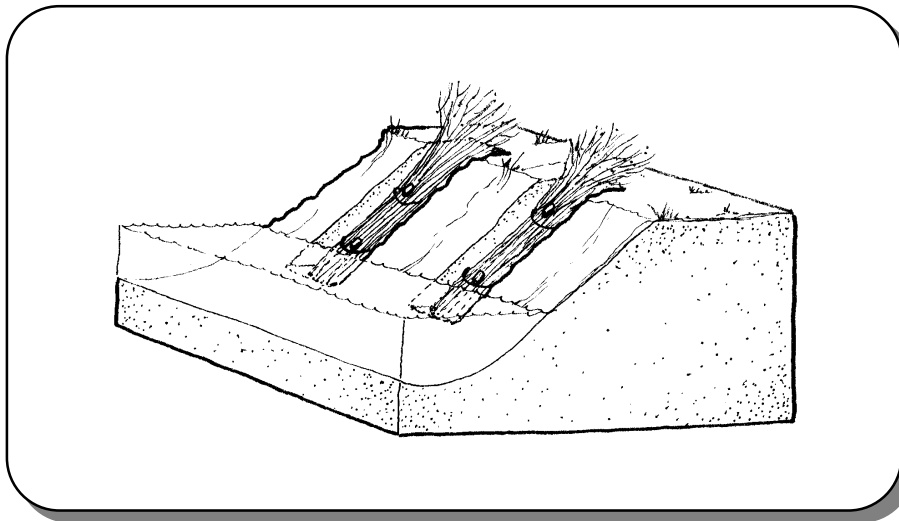
Step Five: Cutting Placement



Backfill soil and water into the trench to remove air pockets.

Step Six: Backfill

Vertical Bundles



Materials:

- o willow cuttings
- o clothesline cord or wire
- o chain saw or loppers (to harvest willows)
- o shovel
- o 1 person minimum

Description and Use

This technique uses bundles of willow cuttings (*Salix* spp.) placed in vertical trenches along an eroding streambank. The willow cuttings will sprout and take root, thus stabilizing the streambank with a dense matrix of roots. Revetment and/or erosion control fabric should be used to protect the bundles until they have become established. This technique is good for areas with fluctuating water levels.

How To Install

1. Harvest willow cuttings from a local willow stand that is in healthy condition taking no more than 2/3 of each plant.

Cuttings should be at least 1/2 inch in diameter or larger to ensure an adequate supply of stored energy for rooting, but there should be a good mixture of various sizes. This is to ensure better entrapment of sediment that will promote better root growth.

Cuttings should be collected during the dormant season to ensure the highest success rate. Cuttings can be collected during the growing season if all the leaves are removed from the stem, although establishment success will be lowered. Spring plantings are generally more successful than fall plantings.

2. The cuttings should be tied into bundles approximately 3 to 18 inches in diameter depending

upon use and position with all the growing tips orientated up. The terminal bud should be removed so that stem energy will be re-routed to the lateral buds for more efficient root and stem sprouting.

3. The bundles should be soaked for 5 to 7 days.

4. Excavate a vertical trench with a slope of 2:1 or more in the streambank. Make sure the bottom of the trench will still be under water during low flows.

5. The trenches should be excavated approximately 3 foot centers to ensure adequate protection of the streambank and to encourage rapid growth to fill in between the bundles.

6. Place the bundles in the trenches with the cut ends in the water and then secure them to the bank with wooden stakes. In tight soil, spud links or rebar can be used instead of wooden stakes. Partially backfill around the bundles with soil.

7. It may be desirable to cover the bundles with some type of erosion control fabric to hold the soil in place. See "Erosion Control Fabric Technique" sheets.

8. Brush revetment or other suitable toe protection should also be installed to protect the toe of the bank from scour. Be sure to protect both the upstream and downstream ends of the treatment area to prevent flows from getting behind the bundles.

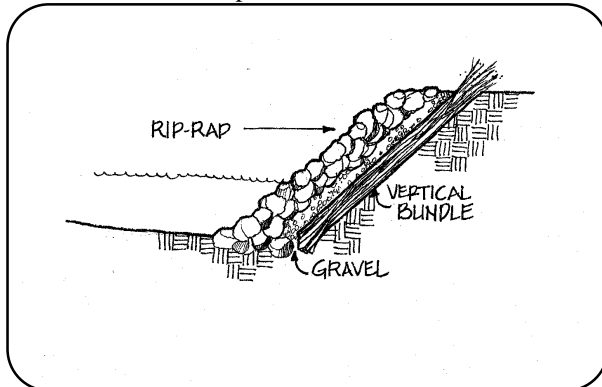


Vertical Bundles

Inventory & Planning Considerations

1. Coyote willow (*Salix exigua*) is a particularly good species for this method because of its' dense root system. This technique can also be used with a mixture of redbud dogwood (*Cornus spp.*) and willow, but to encourage dogwood rooting, the stems will need to be manually nicked or cut and treated with rooting hormone.

2. Some protection should always be placed in front of the bundles. In particular, the toe of the slope is very susceptible to erosive flows and scour. Analysis and calculations of forces will provide guidance for suitable toe protection (see Chapter 3 Streambank Bioengineering Guide). Careful attention must be given to both endpoints of the treatment to prevent flows from getting behind the bundles. Tying into existing features on site, such as trees, rocks, etc. or utilizing additional brush revetment are some possible solutions.



VERTICAL BUNDLES UNDERNEATH RIP-RAP

3. In areas where rip-rap is being placed, vertical willow bundles can be installed prior to placement of the rip-rap. Instead of installing a geotextile fabric on the streambank, pea gravel should be used. This will allow willow growth to protrude through the rip-rap.

4. Never disturb the site unnecessarily. Remember the goal is to stabilize a site. The less it is disturbed, the easier it will be to restore.

Management

To ensure the highest success for the treated area, determine the land management practices that created the eroded streambanks and modify those practices as necessary.

If the area is grazed, restrict livestock from treated areas to allow the eroded section of streambank to heal. Exclosure fences are the most efficient means to accomplish this goal. Managers should resist the temptation to put the exclosure fences at the high water line. The exclosure areas should include enough of the riparian zone to allow the stream to shift naturally over time.

If the area is farmed, a riparian buffer strip should be established and maintained. A buffer strip on both sides of the stream should be set aside to allow for natural riparian vegetation and stream function. A wider buffer strip is strongly encouraged and will yield greater benefits.

Check with your local NRCS district conservationist for cost-share programs and volunteers for fencing, planting, other restoration activities.

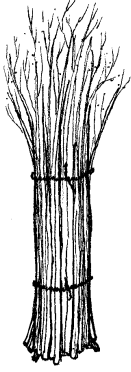
Finally, a stream is an interconnected system and land use practices both upstream and downstream will affect the success of your bioengineering work. Talk with your neighbors and work together to create a healthier riparian and stream system that can benefit everyone.

Monitoring & Maintenance:


Do not ignore the project after it has been installed. Periodic monitoring of the project will provide valuable insight into the stabilization process and may offer important information for future projects.

Periodic maintenance includes making sure the bundles are secured to the streambank and that some soil cover remains on the bundle. Additional plantings may be necessary between the vertical bundles to speed up the rate of vegetative establishment and spread.

Procedure for Vertical Bundles



Harvest and tie cuttings into 3 to 18" diameter bundles depending upon application using 2 pieces of twine.

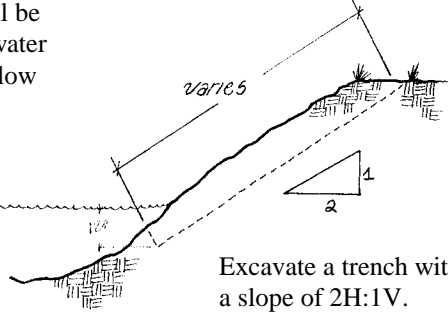


3-18" or as required by the design.

Soak the bundles for 5 to 7 days. Remove them from the water before roots emerge.

Step One: Acquire Willow Cuttings

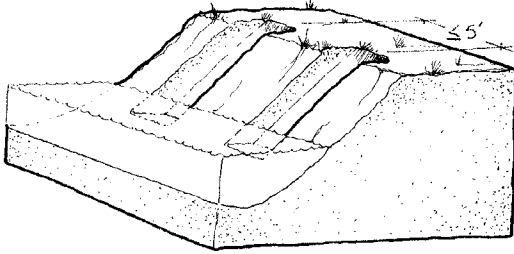
Make sure the bottom of the trench will still be under water during low flows.



Excavate a trench with a slope of 2H:1V.

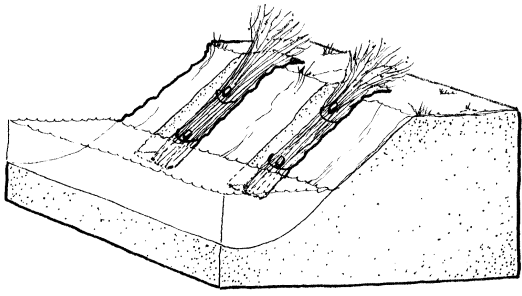
Step Two: Excavate Trench

Excavate trenches on 3 to 5 foot centers.



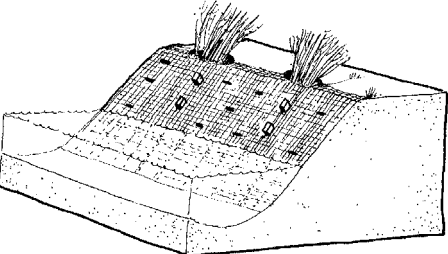
Step Three: Horizontal Spacing

Secure bundles to trench with stakes and partially backfill. Make sure cut ends are in the water.



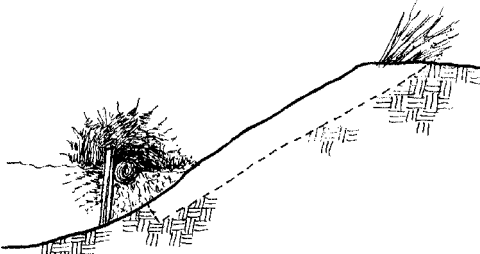
Step Four: Bundle Placement

Option 1: Secure erosion control fabric over the bundles. See "Erosion Control Fabric Technique Sheet". Stake on both sides of bundle to secure fabric.



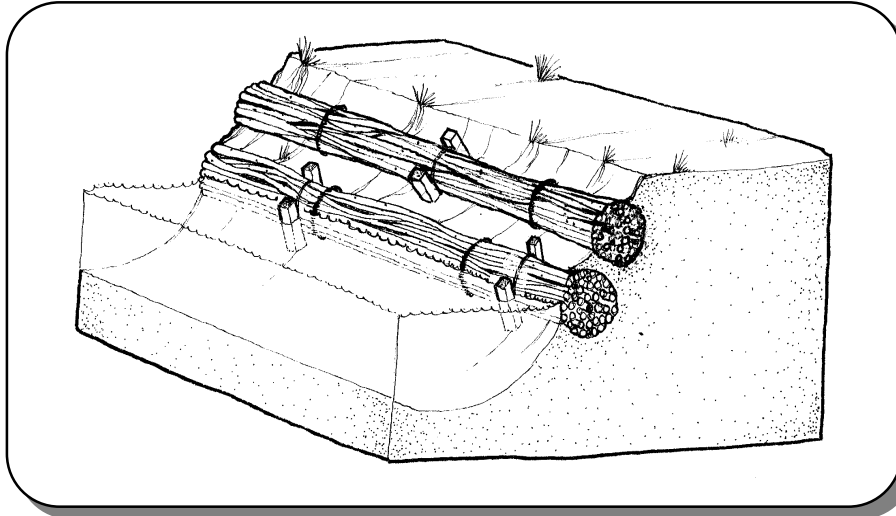
Final Step: Fabric Placement

Option 2: Secure brush revetment or other suitable toe protection at the toe of the slope.



Final Step: Revetment Placement

Willow Wattles or Fascines



Materials:

- o willow cuttings
- o clothesline cord or wire
- o wood stakes
- o chain saw or loppers (to harvest willows)
- o shovel
- o 1 person minimum

Description and Use

Willow wattles (*Salix* spp.) or live fascines are cigar or sausage-like bundles of live cuttings tied together and inserted into a shallow trench dug into the streambank. The willow bundles will sprout and take root, thus stabilizing the streambank with a dense matrix of roots. This is a good technique to break up slope length and minimize erosion.

How To Install

1. Harvest willow cuttings from a local stand that is in healthy condition taking no more than 2/3 of each plant.

Cuttings should be at least a 1/2 inch diameter or larger to ensure an adequate supply of stored energy for rooting, but there should be a good mixture of various sizes. This is to ensure better entrapment of sediment that will promote better root growth. Ideally cuttings should be collected during the dormant season to ensure the highest success rate. Cuttings can be collected during the growing season if all the leaves are removed from the stem, although establishment success will be lowered.

2. The cuttings can be tied into bundles to facilitate transportation to the project site. The terminal bud should be removed so that energy will be re-routed to the lateral buds for more efficient root and stem sprouting.

3. Soak the bundles for 5 to 7 days before planting.

4. After soaking, the bundles should be laid out in one, long sausage-shaped bundle with the cut ends placed in alternating directions. The bundle should be tied every 18 inches.

5. Excavate a horizontal trench 2/3 the diameter of the wattle in the streambank at approximately the low flow line.

6. Place the wattle in the trench and stake every 3 to 4 feet with 24 to 42 inch wedge-shaped wooden stakes. Stake length will depend on soil conditions. Place stakes on both sides of the wattle and wire across the bundle. Backfill around the wattle by knocking the top of the bank on to the wattle, making sure to work soil into the branches.

Often a second wattle is placed up the bank behind the first wattle. If the streambank consists of saturated soils for most of the growing season, a series of wattles can be established up the streambank. However, in the arid and semi-arid regions, there is normally not enough moisture near the surface to establish several layers of wattles. Pole plantings might be a good option behind the initial wattle since the poles will reach the permanent watertable. It should also be noted that some additional toe protection such as rock may be necessary for this technique.



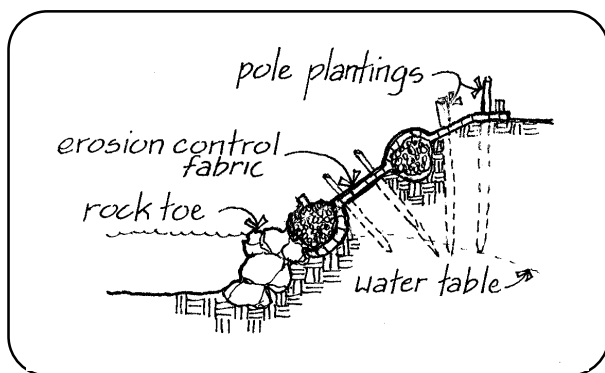
Willow Wattles or Fascines

Inventory & Planning Considerations

1. Coyote willow (*Salix exigua*) is a particularly good species for this method because of its' dense root system. This technique can also be used with a mixture of redbud dogwood (*Cornus spp*) and willows. To encourage rooting in the dogwood, the stems need to be manually nicked or cut and treated with rooting hormone.

2. If this method is used in a highly erodible area, some protection should be placed in front of the wattles to prevent scour. Analysis and calculations of forces will provide guidance for suitable toe protection (see Chapter 3 Streambank Bioengineering Guide). In some cases, brush revetment or fibershines may be adequate (See other Technique Sheets), while other situations may require rock. If no other protection is used, the wattle should be 12 to 24 inches in diameter.

3. Another variation of this technique is to cover the wattles with erosion control fabric to prevent the soil from being washed away from the wattles. Secure the fabric under the first wattle. Poles can be planted into the permanent water table between the wattles. The following illustration also shows the



use of a rock toe to prevent scour.

WATTLES WITH FABRIC AND POLE PLANTINGS

4. Rooting hormones and fertilizers do not significantly improved success for the cost of the materials.

5. Never disturb the site unnecessarily. Remember the goal is to stabilize a site. The less it is

Management

To ensure the highest success for the treated area, determine the land management practices that created the eroded streambanks and modify those practices as necessary.

If the area is grazed, restrict livestock from treated areas to allow the eroded section of streambank to heal. Exclosure fences are the most efficient means to accomplish this goal. Managers should resist the temptation to put the exclosure fences at the high water line. The exclosure areas should include enough of the riparian zone to allow the stream to shift naturally over time.

If the area is farmed, a riparian buffer strip should be established and maintained. A buffer strip on both sides of the stream should be set aside to allow for natural riparian vegetation and stream function. A wider buffer strip is strongly encouraged and will yield greater benefits.

Check with your local NRCS district conservationist for cost-share programs and volunteers for fencing, planting, and other restoration activities.

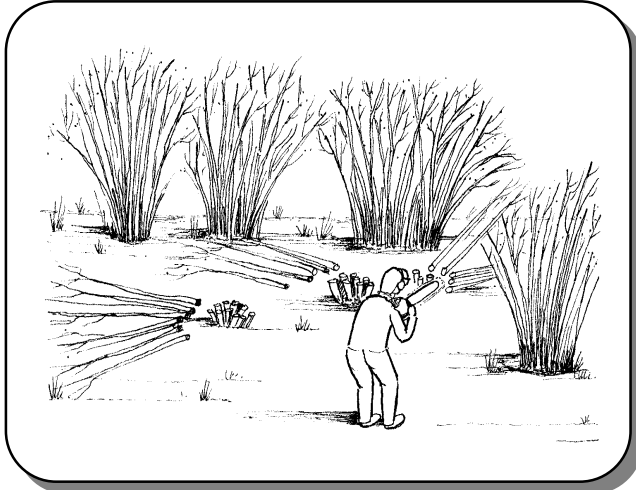
Finally, a stream is an interconnected system and land use practices both upstream and downstream will affect the success of your bioengineering work. Talk with your neighbors and work together to create a healthier riparian and stream system that can benefit everyone.

Monitoring & Maintenance

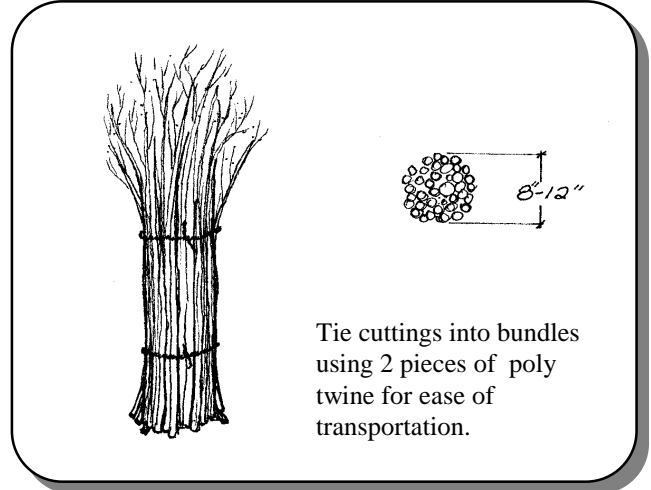
Do not ignore the project after it has been installed. Periodic monitoring of the project will provide valuable insight into the stabilization process and may offer important information for future projects.

Periodic maintenance includes making sure the wattle is secured to the streambank and that some soil cover remains on the wattle. Additional plantings may be necessary to speed up the rate of vegetative establishment and spread.

Procedure for Willow Wattles or Fascines

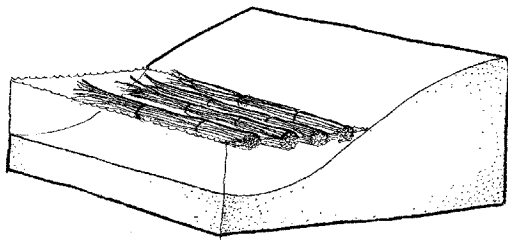


Step One: Harvest Willow Cuttings



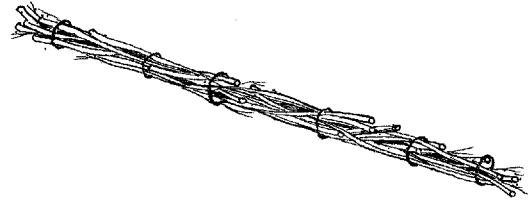
Step Two: Create Willow Bundles

Soak bundles for 5 to 7 days. Remove them from water before roots emerge.



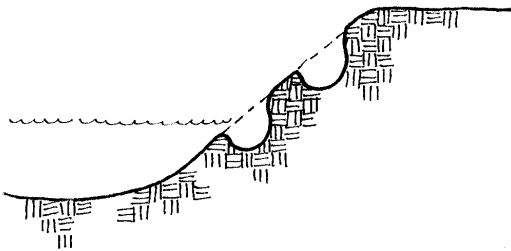
Step Three: Soak Willow Bundles

Build one long sausage-shaped bundle with the cut ends alternating directions. The bundle should be tied every 18 inches.



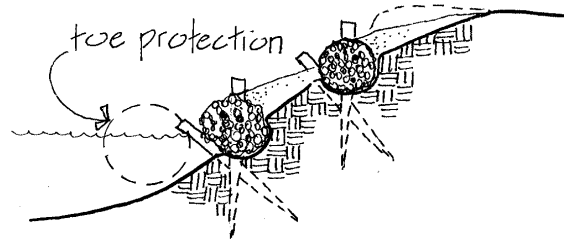
Step Four: Build Wattle

Excavate a horizontal trench 2/3 the diameter of the wattle along the streambank at approximately the low flow line at the toe of the bank.



Step Five: Excavate Trench

Place the wattle in the trench and stake with wedge-shaped stakes. Backfill around the wattle by knocking the top of the bank onto the wattle. Leave some of the branches exposed to sprout.



Step Six: Place Wattle

The Practical Streambank Bioengineering Guide

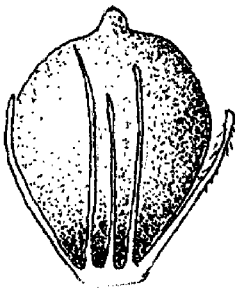
Appendix B Plant Datasheets and Illustrations



Fremont Cottonwood
Populus fremontii



Herbaceous Species Plant Data Sheets



seed
10x

Threesquare Bulrush
Scirpus pungens



2x



Water Sedge - *Carex aquatilis*

Characteristics

Habit:

A short to medium-sized perennial, 10 to 40 inches in height. Rhizomatous, usually occurring in large stands or turf.

Stems:

Slender and triangular.

Leaves:

Alternate, nearly flat and green.

Spikes:

Borne on spikes, usually 1 male spike above the 2 or 3 female spikes, all sessile.

Flowering period: June to August.

Habitat

Distribution:

A fairly common species that can be found at elevations from 5,000 to 10,000 feet. Normally occurs at higher elevations than Nebraska sedge. Often occurs with blue-joint reedgrass and beaked sedge.

Community:

Pond and stream edges, marshes, and wet meadows. Grows on a range of moist soils from loams to silt. Will grow on gravel/sand soils at low elevations.

Hydrology:

Usually found in areas with water depths of 1 to 3 inches season-long. Will decline in water that is 25 in deep. Needs moisture within 8 in of the soil surface.

Wildlife Benefits

Food (seeds, rhizomes):

Waterfowl, upland game birds, and songbirds.

Food (plants):

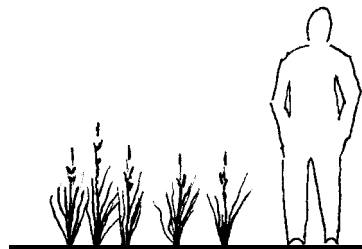
Livestock and other grazers. Fair to good palatability and high production.

Cover:

Nesting waterfowl and small mammal cover.

Comments

Moderate to good tolerance for acidic, saline, and alkaline soils. Biomass below ground is 4x the above ground growth. Can withstand fire without much damage because of the high watertable.



Water Sedge - *Carex aquatilis*

Propagation and Planting

Fruits:

Achenes are oval, tan to brown and approximately 1/16 inch long. Collect by cutting the seedheads with a clipper. A 1/2 to 3/4 grocery bag of bulk material will yield about 1 to 2 cups of seed.

Propagation:

Remove perigynia with sandpaper box. Wet prechill seed for 30 days in a mixture of distilled water and sphagnum moss in a cooler (34 to 38° F). Sprinkle seed on top of soil and press in to ensure seed to soil contact. Keep moist during germination. Plants should be ready for outplanting in 2 to 3 months.

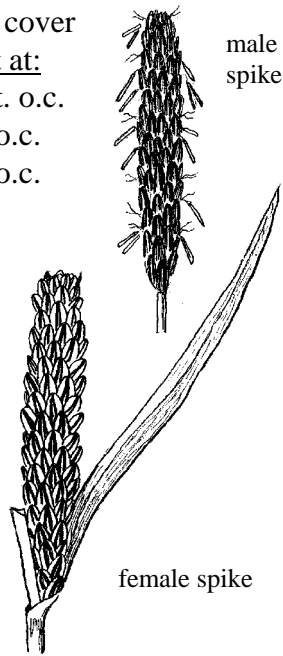
Transplanting:

This species has a slow rate of spread.

Suggested spacing:

For uniform ground cover

	<u>Plant at:</u>
in 1 yr.	0.5 ft. o.c.
in 2 yrs.	1 ft. o.c.
in 3 yrs.	2 ft. o.c.



Nebraska Sedge – *Carex nebrascensis*

Characteristics

Habit:

A short to medium-sized robust perennial, 8 to 40 inches in height. Rhizomatous, usually occurring in dense, multispecies stands.

Stems:

Stout and triangular.

Leaves:

Flat, alternate, triangular, and ranging in color from green to blue.

Spikes:

Borne on spikes, sessile, usually with 1-2 male spikes above the 2-5 female spikes.

Flowering period: May to August.

Habitat

Distribution:

A common species that can be found at elevations from 3,500 to 10,000 feet.

Community:

Pond and stream edges, marshes, wet meadows, seeps, and ditches. Grows on a range of moist, fresh, fine textured soils. Generally does not establish well on gravel or clay soils.

Hydrology:

Usually found in areas with season-long saturated soils, although tolerant of a range of hydrologic regimes. It can tolerate total inundation for up to 3 months.

Wildlife Benefits

Food (seeds, rhizomes):

Waterfowl, upland game birds, small mammals and songbirds.

Food (plants):

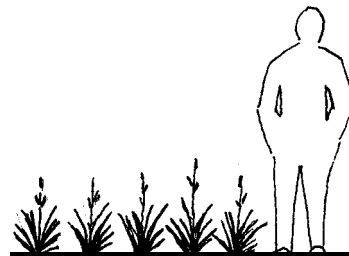
Muskrats, geese, livestock and other grazers. Palitability and production are high.

Cover:

Nesting waterfowl and small mammal cover.

Comments

Tolerates alkaline soils. Excellent soil stabilizer. Forms dense deep root system with root biomasses up to 3000 g/m² in top 20 cm of soil. Used by native americans for mats, bedding, and food.



Nebraska Sedge - *Carex nebrascensis*

Propagation and Planting

Fruits:

Achenes are lenticular, tan to brown and approximately 1/16 of an inch long. Collect by cutting the seedheads with a clipper. A 1/2 to 3/4 grocery bag of bulk material will yield about 1 to 2 cups of seed.

Propagation:

Remove periygnia with sandpaper box. Wet prechill seeds for 30 days in a mixture of distilled water and sphagnum moss in a cooler (34 to 38^o F). Sprinkle seeds on top of soils and press in to ensure seed to soil contact. Keep moist during germination. Plants should be ready for outplanting in 2 to 3 months.

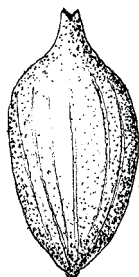
Transplanting:

This species has a rapid rate of spread.

Suggested spacing:

For uniform ground cover

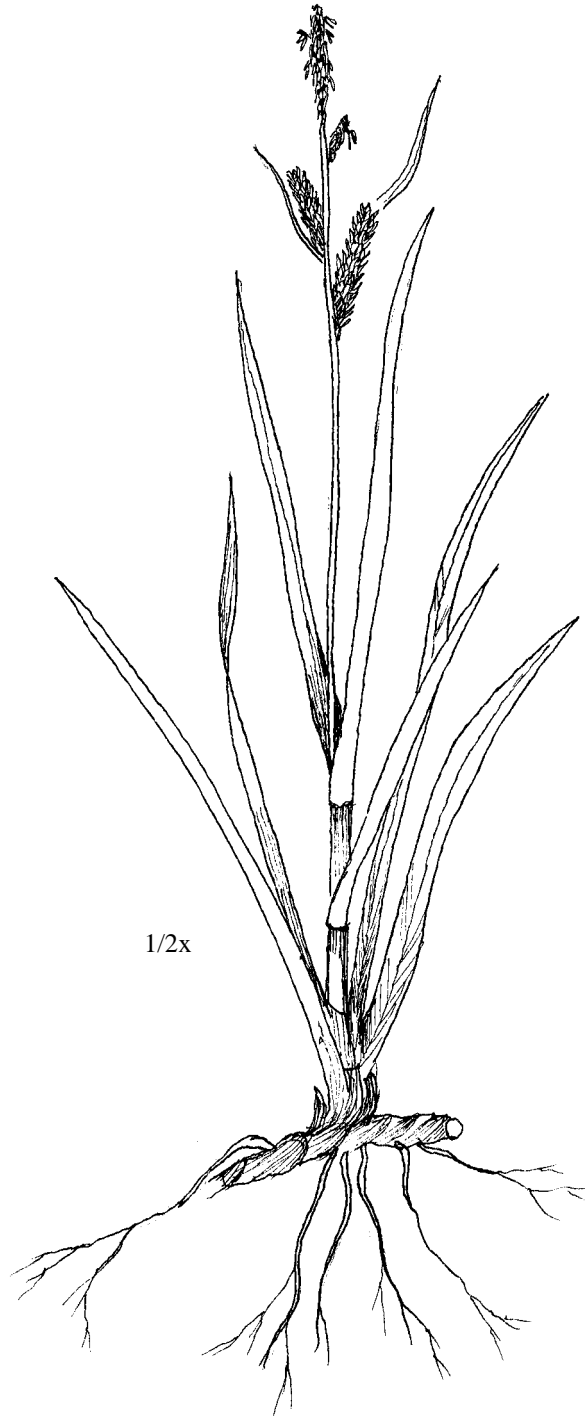
	<u>Plant at:</u>
in 1 yr.	0.5 ft. o.c.
in 2 yrs.	1 ft. o.c.
in 3 yrs.	2 ft. o.c.



Seed
10x



1x



1/2x



Beaked Sedge - *Carex utriculata*

Synonym: *Carex rostrata*

Characteristics

Habit:

A medium-sized perennial, 10 to 50 inches in height. Rhizomatous, usually occurring in large, dense monotypic stands.

Stems:

Slender to stout and triangular.

Leaves:

Alternate, long, nearly flat, and yellowish green in color.

Spikes:

Borne on spikes, usually 2 or 3 male spikes above the 2 or 3 female spikes. Flowering period: June to August.

Habitat

Distribution:

A fairly common species that can be found at elevations from 5,000 to 10,000 feet. Normally occurs at higher elevations than Nebraska sedge.

Community:

Pond and stream edges, marshes, wet meadows, and springs. Grows on a range of moist soils from loams to silt. Does not occur on gravel/sand or clay soils.

Hydrology:

Generally found in areas with season-long saturated soils, tolerates a range of hydrologic regimes. Can grow in water that is 15-30 in. deep.

Wildlife Benefits

Food (seeds, rhizomes):

Waterfowl, upland game birds, small mammals, and songbirds.

Food (plants):

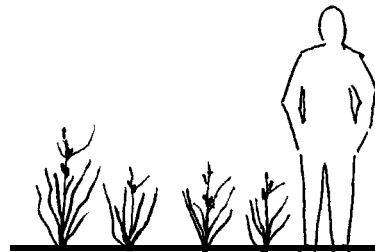
Big game and other grazers early in the season. Protein levels are low to moderate.

Cover:

Nesting waterfowl and small mammal cover.

Comments

Moderate tolerance for acidic and alkaline soils. Can spread by fragmentation. Rhizomes and roots are 2-5x the biomass of the above ground growth. Excellent plant for creating overhanging banks on streams. Difficult to burn.



Beaked Sedge - *Carex utriculata*

Propagation and Planting

Fruits:

Achenes are triangular, tan to brown and approximately 1/8 inch long. Collect by cutting the seedheads with a clipper. A 1/2 to 3/4 grocery bag of bulk material will yield about 1 to 2 cups of seed.

Propagation:

Remove perigynia with sandpaper box. Wet prechill seed for 30 days in a mixture of distilled water and sphagnum moss in a cooler (34 to 38° F). Sprinkle seeds on top of soil and press in to ensure seed to soil contact. Keep moist during germination. Plants should be ready for outplanting in 2 to 3 months.

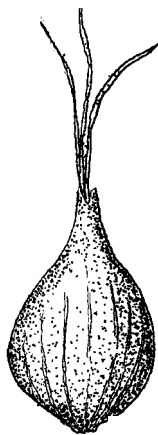
Transplanting:

This species has a medium rate of spread.

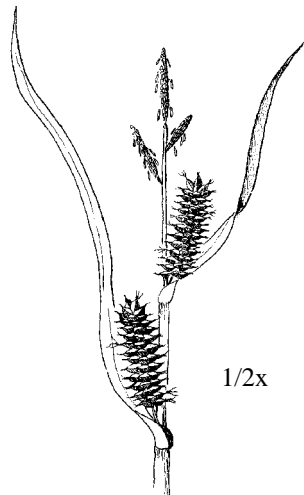
Suggested spacing:

For uniform ground cover Plant at:

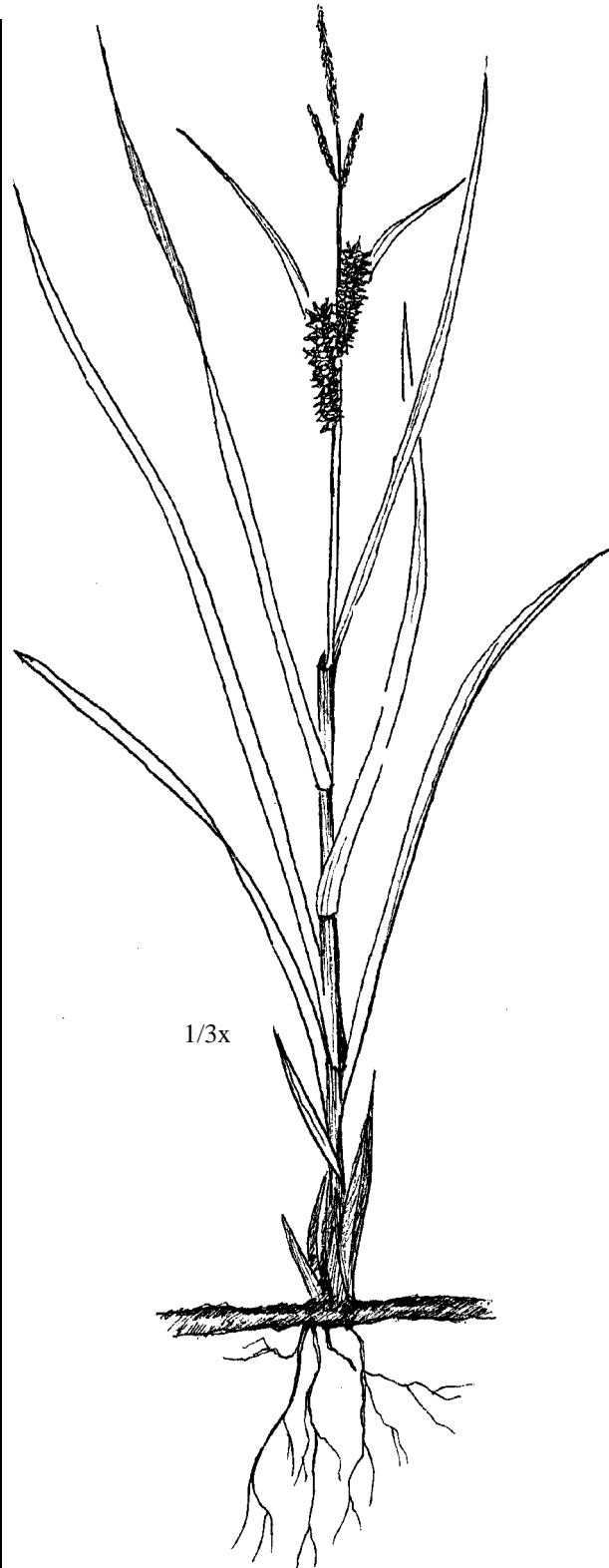
in 1 yr.	0.5 ft. o.c.
in 2 yrs.	1 ft. o.c.
in 3 yrs.	2 ft. o.c.



seed
10x



1/2x



1/3x



Creeping Spikerush - *Eleocharis palustris*

Characteristics

Habit:

An erect perennial, 4 to 40 inches in height. Rhizomatous, usually occurring in monotypic stands.

Stems:

Dark green, oval.

Leaves:

Small, with reddish basal sheath.

Spikes:

Solitary terminal spikelets, 0.25 to 0.75 inches long. Perfect flowers (contain both female and male parts).

Flowering period: June to August.

Habitat

Distribution:

Very common species that can be found at elevations from 3,000 to 10,000 feet.

Widespread over central and northern US.

Community:

Wet meadows, pond, and stream edges, lake basins, and stream margins. Grows on a range of moist, fine textured soils.

Uncommon on gravel or clay soils.

Hydrology:

Generally found in areas with season-long saturated soils or standing water up to 6 inches deep, although it will tolerate long periods of flooding.

Wildlife Benefits

Food (seeds, rhizomes):

Ducks and geese.

Food (plants):

Rabbits, muskrats, big game, and other grazers. High spring protein content.

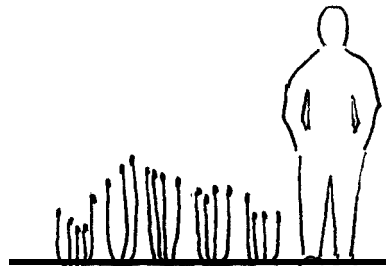
Cover:

Small mammal, nesting waterfowl, and songbird cover.

Comments

Excellent tolerance for alkaline and saline soils. Can fix atmospheric nitrogen.

Good around troughs and ponds because it resists trampling.



Creeping Spikerush - *Eleocharis palustris*

Propagation and Planting

Fruits:

Achenes are flattened and approximately 1/16 inch long including the tubercle. Collect by cutting the tops with a grass clipper. A grocery bag of spikes will produce about 2/3 to 1 cup of seed.

Propagation:

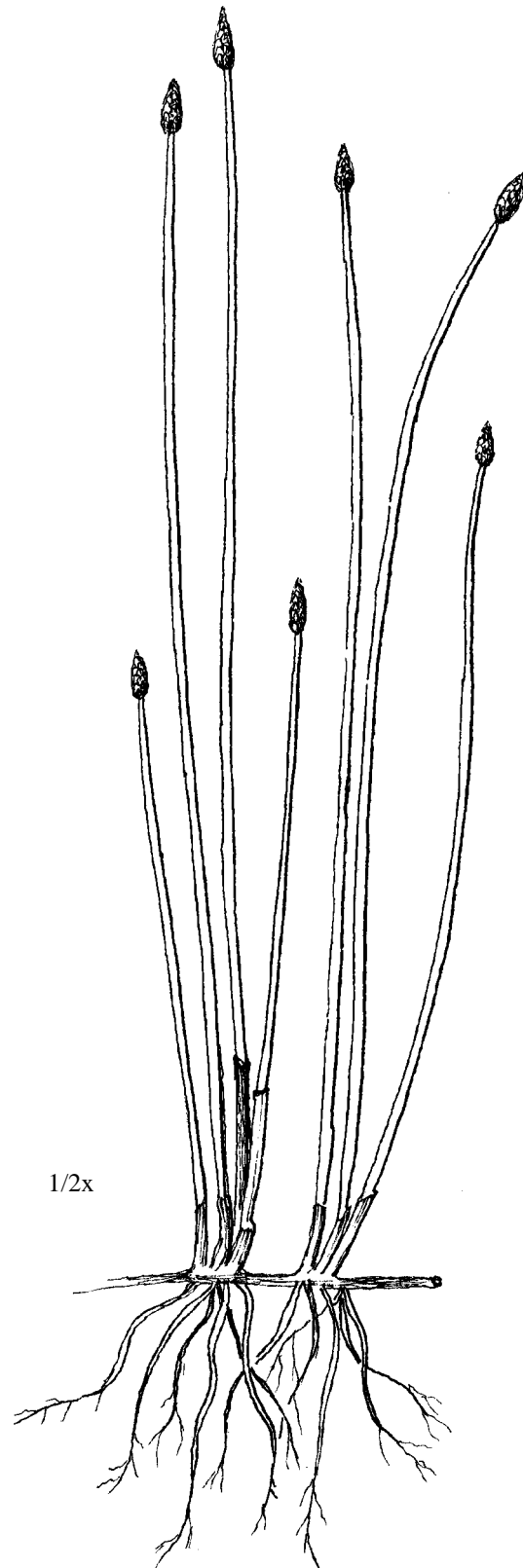
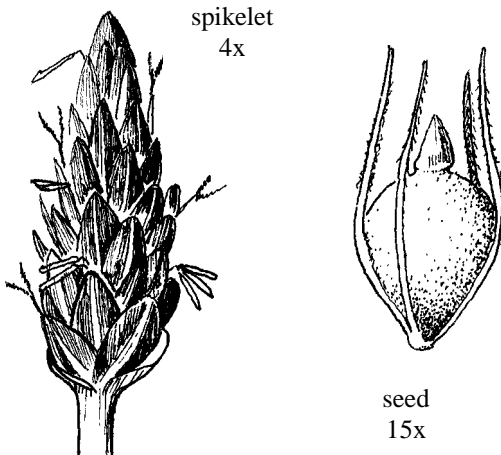
Wet prechill seeds for 30 days in a mixture of distilled water and sphagnum moss in a cooler (34 to 38° F). Sprinkle seed on top of soil and press in to ensure seed to soil contact. Keep moist during germination. Plants should be ready for outplanting in 2 to 3 months.

Transplanting:

This is an excellent species for transplanting because of its dense rhizomes and high growth rate.

Suggested spacing:

<u>For uniform ground cover</u>	<u>Plant at:</u>
in 1 yr.	1 ft. o.c.
in 2 yrs.	2 ft. o.c.
in 3 yrs.	3 ft. o.c.



Baltic Rush - *Juncus balticus*

Characteristics

Habit:

A medium-sized perennial, 18 to 30 inches in height. Rhizomatous, usually occurring in large, dense monotypic stands.

Stems:

Dark green, round and either straight or wiry.

Leaves:

Short, linear basal sheaths, very insignificant.

Panicle:

Loose to compact, sessile lateral panicles. Seeds held in a capsule. Flowering period: May to September.

Habitat

Distribution:

A very common species that can be found at elevations from 3,000 to 10,000 feet throughout the US.

Community:

Pond and stream edges, marshes, wet meadows, wet depressions, and springs. Grows on a range of moist soils from sand to silt, uncommon on very coarse substrates.

Hydrology:

Generally found in areas with season-long saturated soils. Will tolerate wide variety of flooding or drought conditions. Can survive water tables 3 m or more below the surface.

Wildlife Benefits

Food (seeds, rhizomes):

Waterfowl, upland game birds, small mammals, and songbirds.

Food (plants):

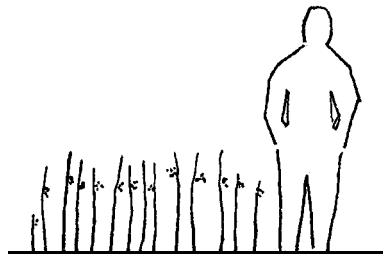
Waterfowl, big game and other grazers (early spring). Palatability declines over the season.

Cover:

Waterfowl, songbirds, and small mammal cover.

Comments

Good tolerance for alkaline and acidic soils. Excellent soil stabilizer with deep roots. Can be used around water troughs and ponds to decrease effects of trampling. Native Americans use it for mats and weaving baskets.



Baltic Rush - *Juncus balticus*

Propagation and Planting

Fruits:

Seeds range in color from gray to reddish or brown. Very, very small seeds. Collect by cutting the seedheads with a clipper. Care must be taken since the seeds are so small; many may be lost in the folds of paper bags.

Propagation:

Wet prechilling is not necessary for this species. Soak seeds in water for 3-5 days before seeding. Sprinkle seeds on top of soil and press in to ensure seed to soil contact. Keep moist during germination. Plants should be ready for outplanting in 2 to 3 months.

Transplanting:

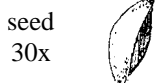
This species has a rapid rate of spread.

Suggested spacing:

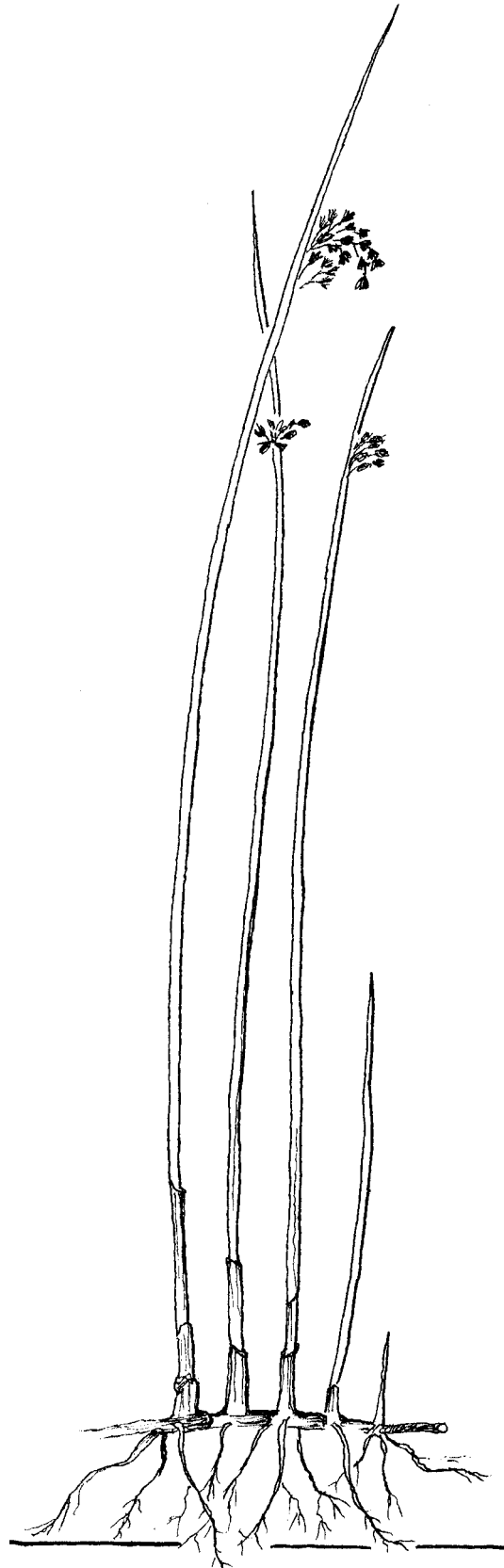
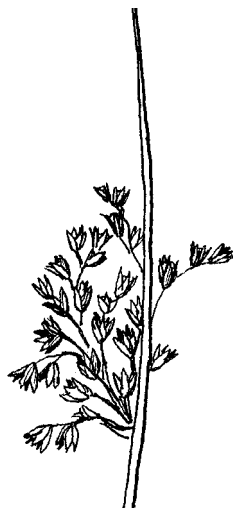
<u>For uniform ground cover</u>	<u>Plant at:</u>
in 1 yr.	0.5 ft. o.c.
in 2 yrs.	1 ft. o.c.
in 3 yrs.	2 ft. o.c.



capsule
6x



seed
30x



Hardstem Bulrush - *Scirpus acutus*

Synonym: *Schoenoplectus acutus* var. *acutus*

Characteristics

Habit:

A tall, stout perennial, up to 9 feet in height. Rhizomatous, usually occurring in large, monotypic stands.

Stems:

Round and pithy, up to 2 inches in diameter at the base.

Leaves:

Short, linear basal sheaths, very insignificant.

Spike:

Terminal spike with up to 50 or more spikelets on a short pedicel.
Flowering period: June to mid-August.

Habitat

Distribution:

Very common species that can be found at elevations from 3,000 to 9,000 feet. Widespread in the US, most common in the western US.

Community:

pond and stream edges, marshes, and lake margins. Often occurs with cattails. Grows on moist silty soils. Usually not found on gravel/sand.

Hydrology:

Generally found in areas of standing water. Can tolerate water up to 5 feet deep. Requires standing or slow moving water.

Wildlife Benefits

Food (seeds, rhizomes):

Waterfowl, upland game birds, songbirds, beaver, and muskrats. It is a very important plant for Western Grebes.

Food (plants):

Muskrats.

Cover:

Nesting waterfowl, fish, and small mammal cover.

Comments

Excellent tolerance for alkaline, brackish, and saline soils. A very important wildlife species. Will recover readily after fire. Excellent protection from wave action.



Hardstem Bulrush - *Scirpus acutus*

Propagation and Planting

Fruits:

Achenes are lenticular, light green to dark brown and approximately 1/8 inch long. Collect by cutting the seedheads with a clipper. A grocery bag of bulk material will yield about 1 to 2 cups of seed.

Propagation:

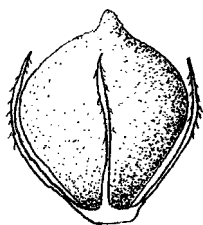
Wet prechill seed for 30 days in a mixture of distilled water and sphagnum moss in a cooler (34 to 38° F). Sprinkle seed on top of soils and press in to ensure seed to soil contact. Keep moist during germination. Plants should be ready for outplanting in 2 months.

Transplanting:

This species has a rapid rate of spread.

Suggested spacing:

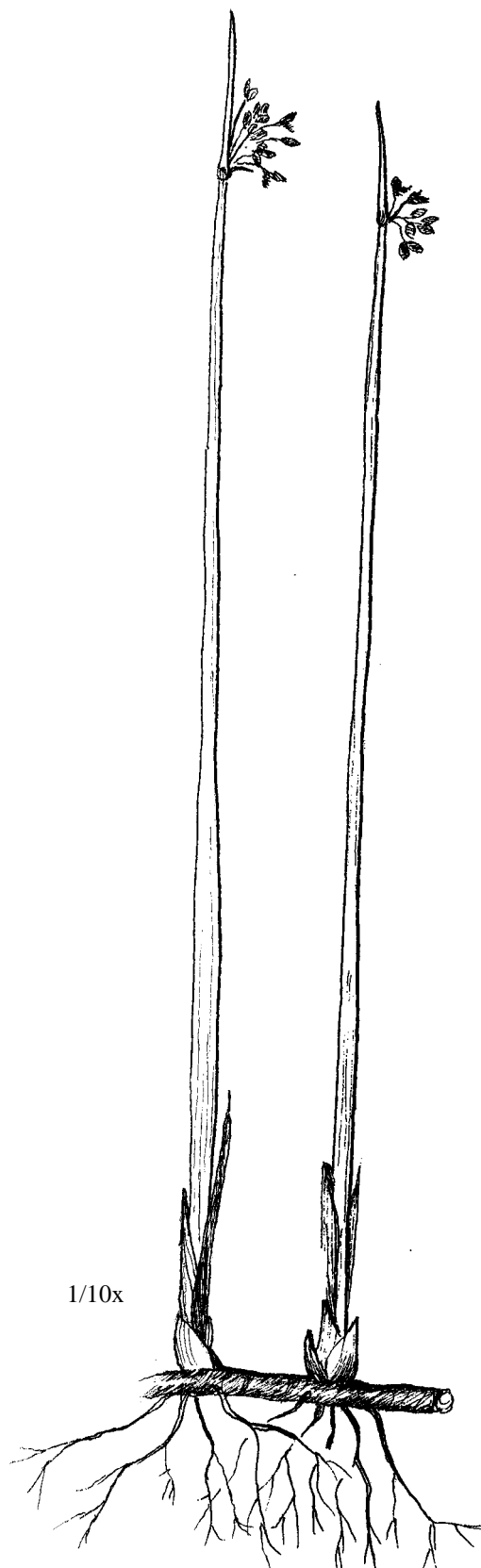
<u>For uniform ground cover</u>	<u>Plant at:</u>
in 1 yr.	1 ft. o.c.
in 2 yrs.	2 ft. o.c.
in 3 yrs.	3 ft. o.c.



seed
12x



1x



1/10x

Alkali Bulrush - *Scirpus maritimus*

Synonym: *Bolboschoenus maritimus*

Characteristics

Habit:

A medium-sized, stout perennial, 8 to 60 inches in height. Rhizomatous, usually occurring in large stands with few other species.

Stems:

Sharply triangular often with concave sides.

Leaves:

Usually several well developed leaves that are borne below the midpoint of the stem.

Spikelets:

Terminal spikelets that are quite compact with 1-3 involucre bracts. Flowering period: July to September.

Habitat

Distribution:

A common species that can be found at elevations from 3,000 to 8,000 feet. Widespread in the Northern Hemisphere.

Community:

Marshes, wet meadows, and pond edges. Often occurs with inland saltgrass. Grows on moist soils from fine clays to silty loams to sands.

Hydrology:

Generally found in areas with season-long saturated soils or standing water up to 3 ft deep. Can survive where the water table drops to 3 ft below the surface.

Wildlife Benefits

Food (seeds, rhizomes):

Waterfowl, upland game birds, and songbirds.

Food (plants):

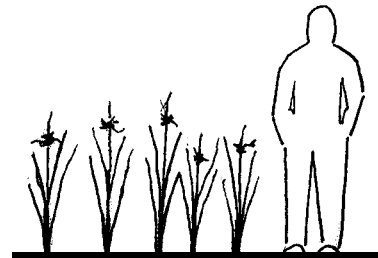
Musk rats and beaver. Grazers rarely use this species.

Cover:

Waterfowl, deer, and small mammal cover. Can provide fish spawning and rearing areas.

Comments

High tolerance for alkaline and saline soils. Small bracts in the seedheads will cause severe irritation to hands and eyes when handling. A pioneering species that will be replaced by other species under good soil and water conditions.



Alkali Bulrush - *Scirpus maritimus*

Propagation and Planting

Fruits:

Achenes are tan to greenish brown and approximately 1/8 inch long. Collect by cutting the seedheads with a clipper, although care should be taken because of the sharp edges on the leaves and stems. A grocery bag of bulk material will yield about 2 cups of seed.

Propagation:

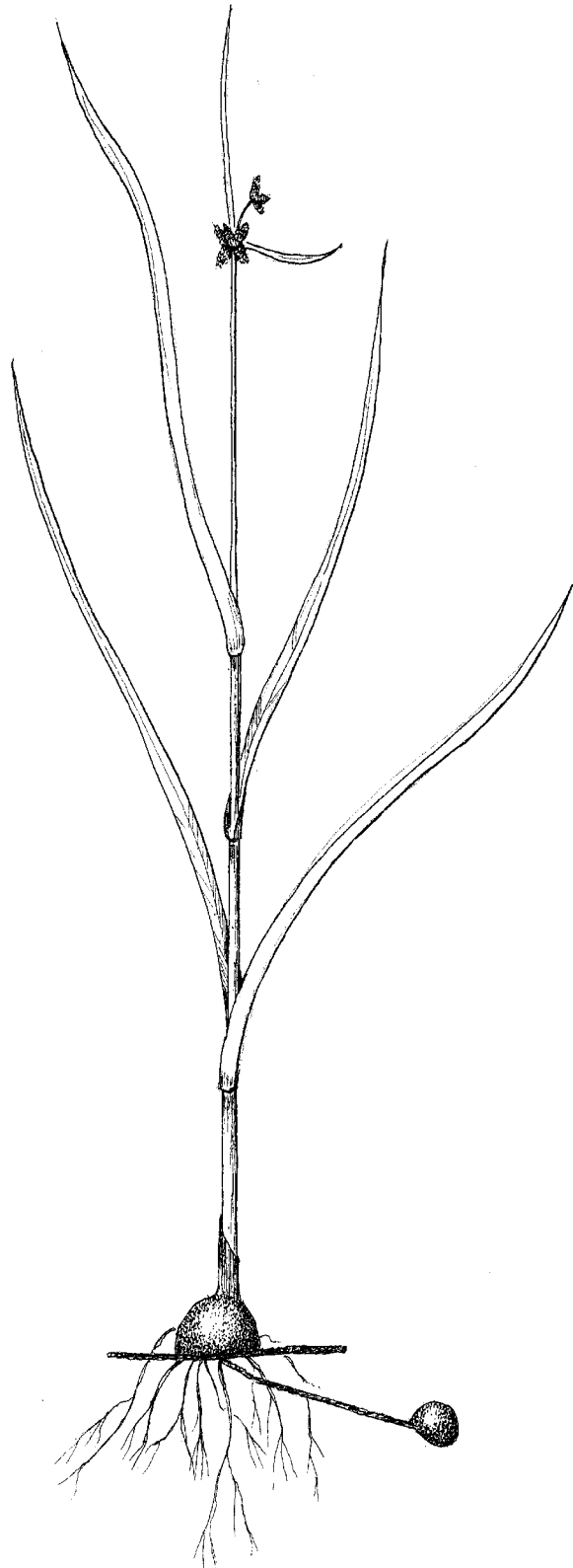
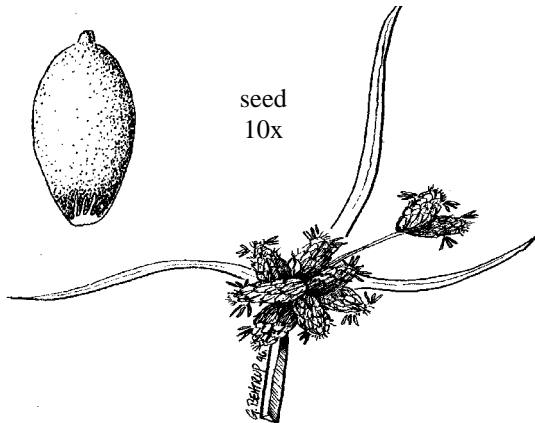
Wet prechill seed for 30 days in a mixture of distilled water and sphagnum moss in a cooler (34 to 38^o F). Sprinkle seed on top of soils and press in to ensure seed to soil contact. Keep moist during germination. Plants should be ready for outplanting in 2 months.

Transplanting:

This species has a medium rate of spread.

Suggested spacing:

<u>For uniform ground cover</u>	<u>Plant at:</u>
in 1 yr.	0.5 ft. o.c.
in 2 yrs.	1 ft. o.c.
in 3 yrs.	2 ft. o.c.



~~Threesquare Bulrush~~ – *Scirpus pungens*

Synonym: *Schoenoplectus pungens*

Characteristics

Habit:

A medium-sized, erect perennial, 6 to 40 inches in height. Rhizomatous, usually occurring in large, monotypic stands.

Stems:

Upright, triangular with flat sides, rarely concave.

Leaves:

Borne near the base.

Spikelets:

Lateral cluster of 1-6 sessile spikelets. Subtended by an involucre bract that appears to be a continuation of the stem. Flowering period: June to September.

Habitat

Distribution:

Very common species that can be found at elevations from 3,000 to 6,500 feet. Common throughout the US.

Community:

Pond and stream edges, marshes, and lake fringes. Prefers fine silty clay loams, but grows on sandy-loam, uncommon on gravel/sand.

Hydrology:

Generally found in areas with season-long saturated soils or standing water up to 6 inches deep. It will tolerate long periods of drought.

Wildlife Benefits

Food (seeds, rhizomes):

Muskrats, geese, and other waterfowl.

Food (plants):

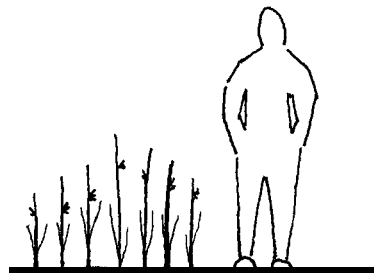
Grazers will use early growth. Palatability and production is low.

Cover:

Waterfowl, muskrats, and small mammal cover.

Comments

Excellent tolerance for saline and alkaline soils. Germination is primarily by seed. Will spread readily by rhizomes.



Threesquare Bulrush - *Scirpus pungens*

Propagation and Planting

Fruits:

Achenes are dark green to brown and approximately 1/16-1/8 inch long with slender beaks. Collect by cutting the seedheads with a clipper. A grocery bag of bulk material will yield about 1/2 to 2/3 cup of seed.

Propagation:

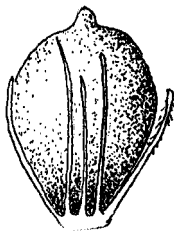
This is a difficult species to propagate from seed, thus transplanting may be the best option.

Transplanting:

This species has a medium to rapid rate of spread.

Suggested spacing:

<u>For uniform ground cover</u>	<u>Plant at:</u>
in 1 yr.	1 ft. o.c.
in 2 yrs.	2 ft. o.c.



seed
10x



2x



1/2x

Common Cattail - *Typha latifolia*

Characteristics

Habit:

A tall, stout perennial, up to 6 feet in height. Rhizomatous, usually occurring in large, monotypic stands.

Stems:

Round and pithy, covered for much of the length by overlapping leaf sheaths.

Leaves:

Flat, ascending, and alternate.

Flowers:

Small on large, dense, brown terminal spikelets, male spike above and separate from the female spike.

Flowering period: June to August.

Habitat

Distribution:

Very common species that can be found at elevations from 3,000 to 7,000 feet.

Community:

Marshes and pond edges. Often found with hardstem bulrush. Grows on a range of moist soils from gravel to clay, uncommon on heavy clay soils.

Hydrology:

Generally found in areas with season-long saturated soils or in standing or slow moving water up to 12 inches deep. It will tolerate long periods of flooding or drought.

Wildlife Benefits

Food (seeds, rhizomes):

Waterfowl and muskrats.

Food (plants):

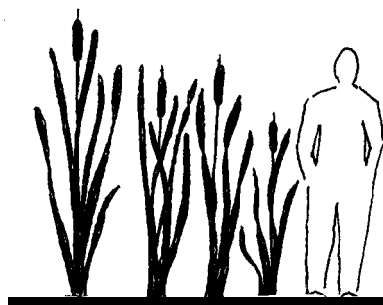
Muskrats

Cover:

Waterfowl and small mammal cover.

Comments

High tolerance for saline soils. Excellent uptake capabilities of nutrients and heavy metals. Can be very invasive.



Common Cattail - *Typha latifolia*

Propagation and Planting

Seeds:

Nutlets are approximately 1/32-1/16 inch long with many long slender hairs that arise from the base. Collect by cutting the spikes with a clipper.

Propagation:

Wet prechill seed for 30 days in a mixture of distilled water and sphagnum moss in a cooler (34 to 38^o F). Sprinkle seed on top of soil and press in to ensure seed to soil contact. Keep moist during germination. Plants should be ready for outplanting in 2 months.

Transplanting:

This is a good species for transplanting methods due to its dense rhizomes and high growth rate.

Suggested spacing:

For uniform ground cover

in 1 yr.

in 2 yrs.

in 3 yrs.

Plant at:

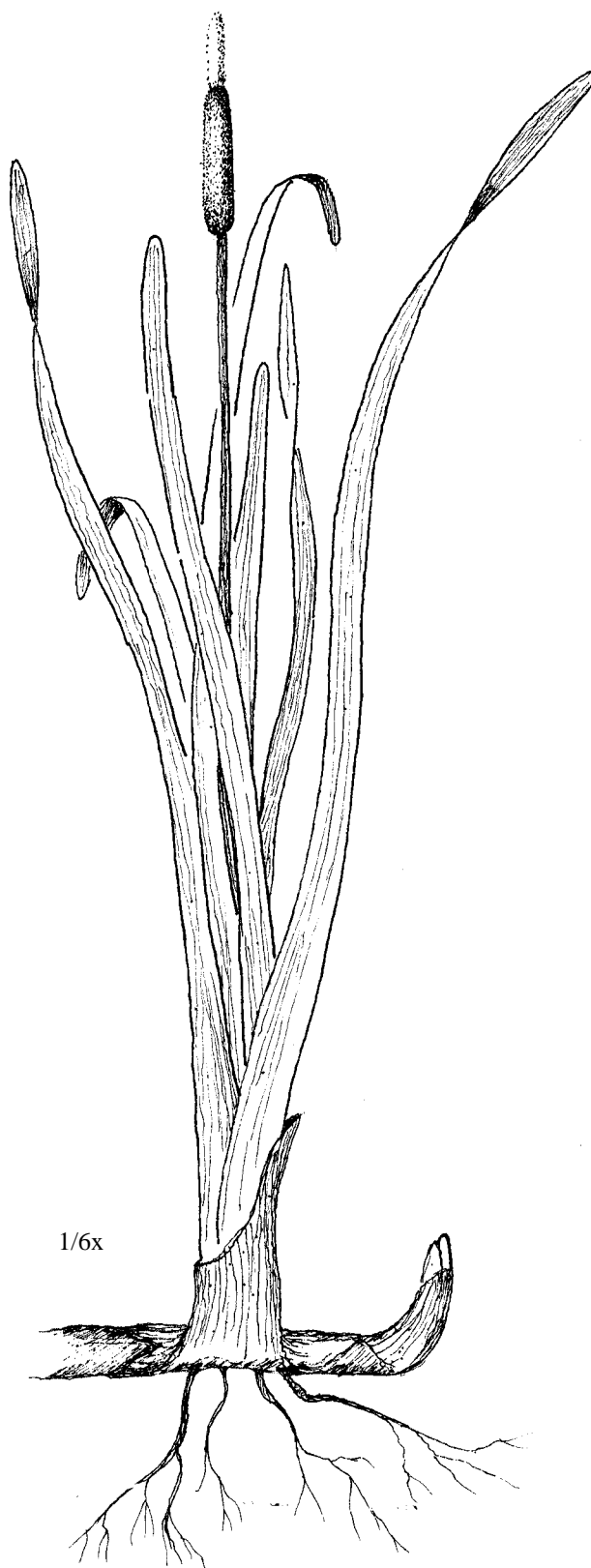
1 ft. o.c.

2 ft. o.c.

3 ft. o.c.



seed



1/6x



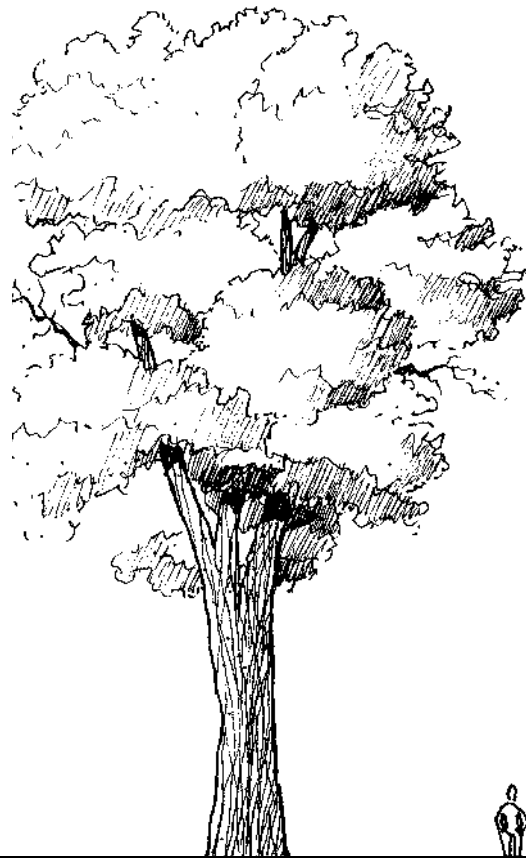
Woody Species Plant Data Sheets



Planeleaf Willow
Salix planifolia



Narrowleaf Cottonwood - *Populus angustifolia*



Characteristics

Habit:

Medium-sized tree with narrow, rounded crown, up to 60 feet in height with trunk diameters from 1 to 2 feet.

Twigs/Bark:

Bark is shallowly fissured with broad, flat ridges. Bark on upper branches is whitish, becoming slightly darker with age.

Leaves:

Leaves are eglandular, lance shaped, broadest near the middle, tapering to a pointed tip with finely toothed margins, and bright yellowish green with a flattened leaf stalk.

Habitat

Distribution:

Throughout the region - 4,000 to 7,000 ft.

Community:

Usually occurs with redosier dogwood and alder. Occupies coarse, cobbly soils that flood frequently. Generally prefers wetter sites.

Growth:

Has good growth rate.

Propagation

Roots easily from hardwood cuttings. Use smooth bark sections.

Fremont Cottonwood - *Populus fremontii*



Characteristics

Habit:

Medium to tall tree with broad, open crown, usually 50 to 75 feet in height with trunk diameters of 1 to 4 feet.

Twigs/Bark:

Bark is thick, rough, dark gray-brown and splitting with age.

Leaves:

Triangular shaped leaf with broad base. Very irregularly and coarsely toothed. Thick, shiny, green, without glands. The leaf stalk is flattened.

Habitat

Distribution:

From 2,000 to 6,500 feet, mostly in the southern portion of the region.

Community:

Usually occurs with coyote willow. Prefers gravel to sandy soils that flood periodically.

Growth:

Good growth rate. Seems to do well in slightly saline areas.

Propagation

Will root from hardwood cuttings with medium ease.



Black Cottonwood - *Populus trichocarpa*



Characteristics

Habit:

Very tall tree with narrow, rounded, open to pointed crown, up to 160 feet in height. Trunk diameters from 2 to 5 feet.

Twigs/Bark:

Twigs are yellow-gray. Old bark is thick, grayish-brown, and deeply furrowed.

Leaves:

Alternate, smooth, thick, hairless, wedge shaped, and finely round-toothed. Dark green above and silvery with rust colored spots beneath. Leaf stalks are round; a pair of glands are at the base of the leaf.

Habitat

Distribution:

Common from 3,000 to 5,000 feet, more common in the northern part of the region.

Community:

Occurs with whiplash and yellow willow, grows well on coarse soils that are flooded, i.e. floodplains.

Growth:

Good growth rate.

Propagation

Roots easily along entire stem. Use smooth bark sections rather than older,

Peachleaf Willow - *Salix amygdaloides*



Characteristics

Habit:

Tree sometimes up to 90 feet in height with trunks 3 feet in diameter. Often smaller, occurring in clumps and having 1 1/2 to 2 feet diameter trunks.

Twigs/Bark:

Twigs are smooth, shiny gray to red-brown to orange. Bark is grayish brown, shallowly furrowed, and shaggy.

Leaves:

Alternate, simple, lanceolate, finely toothed, somewhat leathery, yellowish green above and pale beneath without any glands or hairs on the petiole.

Habitat

Distribution:

Throughout the region, primarily at low elevations from 2,000 to 6,000 feet.

Community:

Associated with cottonwoods and coyote willow. Often on loamy soils that are saturated seasonally.

Growth:

Tends to have a low growth rate.

Propagation

Good rooting ability, roots up and down the entire stem. Use smooth bark sections rather than deep furrowed sections.



Bebb Willow - *Salix bebbiana*



Characteristics

Habit:

Shrub to small tree, 10 to 30 feet in height with main stems up to 8 inches in diameter.

Twigs/Bark:

Short, reddish brown branches with long hairs.

Leaves:

Leaves narrower at the base and slightly wider at the tip, generally tapering at both ends, dull green above and pale with a waxy bloom beneath, and sparsely hairy. Margin is either entire or coarsely toothed.

Habitat

Distribution:

Common from 3,300 to 7,900 feet, rarely dominant.

Community:

Usually found with aspen and black cottonwood. At low elevations, it grows in moist soils while at higher elevations it will grow in coarser, well drained soils.

Growth:

Tends to have a low growth rate.

Propagation

Difficult to propagate.

Booth Willow - *Salix boothii*



Characteristics

Habit:

Many branched shrub with a rounded top. Generally reaches 6 to 10 (20) feet in height

Twigs/Bark:

Numerous basal stems less than 2 inches in diameter, usually with bright yellow bark.

Leaves:

Green on both sides and slightly toothed. Distinctive feature: Leaves lack a waxy bloom and have few if any hairs.

Habitat

Distribution:

Most common willow from 4,500 to 8,000 feet.

Community:

Usually found with geyer and drummond willow. Most common on wet, coarse soil. Does grow on fine-textured soils.

Growth:

Good growth rate.

Propagation

Roots well from hardwood cuttings, easy to propagate.



Barrenground Willow - *Salix brachycarpa*



Characteristics

Habit:

Small rounded, compact shrub up to 3 feet in height.

Twigs/Bark:

Reddish under a dense covering of hairs.

Leaves:

Small, oval-shaped with entire margins. Older leaves with fine wooly hairs on both sides.

Habitat

Distribution:

Throughout the region from 4,500 to sometimes as high as 9,000 ft.

Community:

Occurs on a wide range of sites and soils. Needs wetter sites at lower elevations than at higher elevations. Can tolerate saline conditions.

Growth:

Slow to moderate growth.

Propagation

Roots along entire stem, moderate to good rooting.

Drummond Willow - *Salix drummondiana*



Characteristics

Habit:

Shrub with open growth form, up to 6 to 12 feet in height.

Twigs/Bark:

Green to reddish purple twigs that are covered with a whitish waxy bloom.

Leaves:

Leaves narrow at the base, widening out at the middle and rounded at the apex. Dark green on top. Underside has a pubescence that appears to be a waxy bloom, but won't rub off. Edges of the leaves are rolled under.

Habitat

Distribution:

Throughout region from 4,500 to 9,000 ft, abundant at higher elevations.

Community:

Usually associated with Engelmann spruce and subalpine fir on coarse textured soils that are moist and well aerated.

Growth:

Moderate growth rate.

Propagation

Roots along entire stem with good to excellent rooting.

Coyote Willow - *Salix exigua*



Characteristics

Habit:

Shrub 3 to 15 (27) feet in height, thicket forming with numerous slender stems.

Twigs/Bark:

New twigs are reddish brown turning to ashy gray when older.

Leaves:

Long and narrow with short petioles, generally green above and pale below. The silvery pubescence on young leaves wears off becoming dull, grayish green.

Habitat

Distribution:

Very common species from 2,000 to 7,000 ft.

Community:

Associated with cottonwood, whiplash and yellow willow. Grows on moist soils, from gravel to silt.

Growth:

Grows rapidly.

Propagation

Roots freely from cuttings, easiest species to propagate.

Synonymy: Sometimes referred to as sandbar or dusky willow. Two major subspecies are recognized, *Salix exigua* ssp. *exigua* and *Salix exigua* ssp. *melanopsis*. *Salix exigua* ssp. *exigua* is often referred to as gray sandbar willow. *S. exigua* ssp. *melanopsis* is a smaller shrub with wider, darker, greener leaves. Within the ssp. *melanopsis*, a variety *tenerrima* is recognized by its extremely narrow, predominantly toothed leaves. All of the recognized subspecies and varieties are rhizomatous, thicket-forming willows. For more information refer to Brunfeldt and Johnson (1985).

Geyer Willow - *Salix geyeriana*



Characteristics

Habit:

Shrub with numerous straight branches, up to 10 to 15 (20) feet in height arising from a tight basal cluster.

Twigs/Bark:

Green and covered with a white waxy coating.

Leaves:

Leaves are dark green and hairy above, with a waxy bloom underneath that can be rubbed off.

Note: Closely related to Lemmon willow and may be synonymous.

Habitat

Distribution:

Throughout this region from 4,000 to 8,000 feet. Often found on side drainages.

Community:

Usually found with booth willow which will occupy wetter zones while geyer willow will occupy drier sites. Most common on deep, fine textured soils.

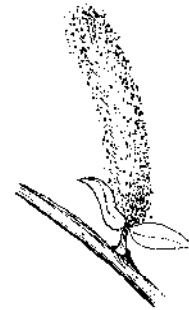
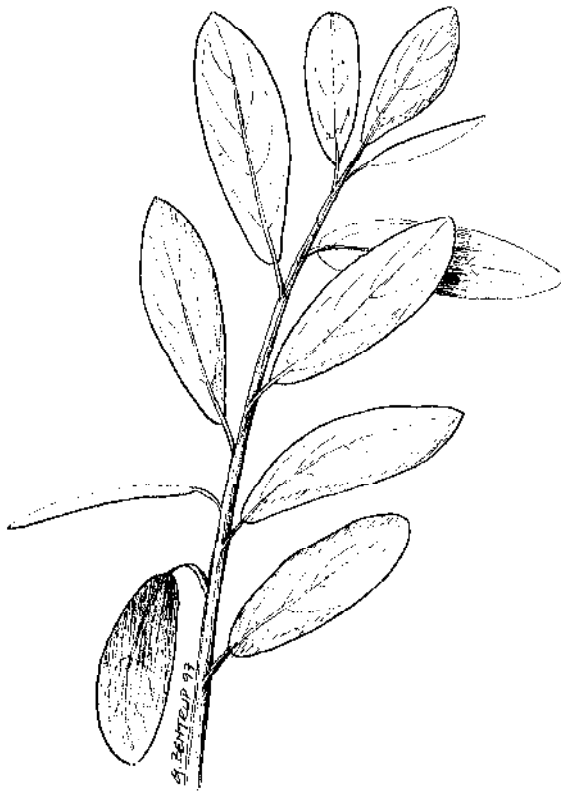
Growth:

Good growth rate.

Propagation

Roots along entire stem and has good rooting abilities.

Arroyo Willow - *Salix lasiolepis*



Characteristics

Habit:

Shrub or tree from 12 to 30 feet in height.

Twigs/Bark:

Yellow to reddish dark brown; softly hairy when young.

Leaves:

Seldom more than 3 times longer than wide, margins entire. Lower surface hairy with a waxy bloom.

Habitat

Distribution:

Found at low elevations. Most common in the southern portion of our region, uncommon elsewhere.

Community:

Sometimes with Fremont cottonwood. Grows in coarse, rocky soils.

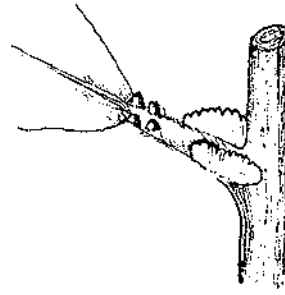
Growth:

Moderate growth rate.

Propagation

Roots erratically and is difficult to propagate successfully.

Pacific Willow - *Salix lasiandra*



Characteristics

Habit:

Tree with several main stems and a dense green crown, up to 50 feet in height. Stems often 4 to 12 inches in diameter.

Twigs/Bark:

Twigs covered with a fine pubescence, Bark is rough and brown.

Leaves:

Long, lanceolate with finely toothed margins, green on both sides, lacking a waxy bloom. Apex of leaf has a curving point, hence the name whiplash. Distinctive glands are found on the petioles at the base of the leaf.

Habitat

Distribution:

Common in the region from 2,000 to 6,000 ft (below 6,500).

Community:

Often occurs with black cottonwood and yellow willow. Likes moist sandy to gravelly soils.

Growth:

Medium growth rate.

Propagation

Easy to propagate from 2- to 4-year old stems, older stems root more slowly.



Yellow Willow - *Salix lutea*



Characteristics

Habit:

Rounded shrub, occasionally becoming a multi-stemmed tree, up to 20 feet in height.

Twigs/Bark:

Twigs yellowish white to gray, not hairy.

Leaves:

Green above and pale with a waxy bloom beneath, margins are finely toothed especially near the apex. Older leaves lack hairs. The stipules are somewhat persistent.

Habitat

Distribution:

Very common from 2,000 to 4,500 feet.

Community:

Commonly found with coyote and pacific willow. In a variety of sites from coarse cobble along streams to moist terraces with deep, fine textured soils.

Growth:

Grows at good rate.

Propagation

Roots easily along the entire stem from hardwood cuttings.

Planeleaf Willow - *Salix planifolia*



Characteristics

Habit:

Low, compact and rounded shrub, up to 3 to 4 feet in height.

Twigs/Bark:

Older twigs are dark red without hairs.

Leaves:

Dark, shiny green above with a waxy bloom underneath; margins are entire or slightly toothed; lateral veins are prominent.

Habitat

Distribution:

Throughout area at upper mid elevations to 7,000 ft.

Community:

Occurs with wolf willow at higher elevations and booth willow at lower elevations. Grows in continually saturated, high organic soils.

Growth:

Slow growth.

Propagation

Roots along the entire stem; fair rooting

Scouler Willow - *Salix scouleriana*



Characteristics

Habit:

Large shrub to small multi-stemmed tree 20 to 35 feet in height. Stems often 4 to 8 inches in diameter.

Twigs/Bark:

Reddish orange to dull yellow and dotted with corky spots. Bark stripped from second year twigs smells skunky.

Leaves:

Wider at the top than at the base. Dark, shiny green above, covered with dense reddish hairs below.

Habitat

Distribution:

Throughout the region from 3,000 to 8,000 ft.

Community:

Often grows with Bebb willow. Small tree height at low elevations. At higher elevations, it occupies drier slopes. Only "upland willow" in this region.

Growth:

Very slow growth rate.

Propagation

Roots from cuts with a rooting hormone. Difficult to propagate; low success rate.

Wolf Willow - *Salix wolfii*



Characteristics

Habit:

Low rounded shrub, rarely over 2 feet in height.

Twigs/Bark:

Covered with a pubescence.

Leaves:

Gray-green, covered with densely silvery pubescence and hairy at maturity.

Habitat

Distribution:

Found from 6,500 to 9,000 ft.

Community:

Occurs with Geyer and lemmon willow on wetter sites at mid elevations. Occupies drier sites at higher elevations. Occurs on sandy, well-drained and aerated soils.

Growth:

Very slow growth rate.

Propagation

Roots along entire stem, though rooting is erratic. Definitely treat with a rooting hormone.

The Practical Streambank Bioengineering Guide

Appendix C Sample Monitoring Sheet



Bioengineering Monitoring Sheet

Project Name: _____ Project Location: _____
Monitoring Team: _____ Date: _____

Bioengineering Technique: _____
Riparian Species Present: _____

Total # of poles or post plantings: _____
of dead: _____ # of live: _____
% survival: _____
Average height: _____
Average # of live stems per linear foot: _____
Average height of stems per linear foot: _____
Stem density per unit area: _____

Notes: _____

STREAM CROSS-SECTION ID#: _____ Measuring Tape Height: x _____ y _____

A large rectangular grid for data collection, consisting of 20 columns and 30 rows of squares.

Scale: _____



August 28, 2018

Randy & Kami Soule
13390 Welcome Way
Reno, NV 89511

Certified Mail#
9171 9690 0935 0039 9478 30

Site Name: Soule Property APN: 049-165-05

Re: Cease and Desist for Construction without a Permit

Dear Mr. and Mrs. Soule,

The Nevada Division of Environmental Protection's (Division) Bureau of Water Pollution Control was notified on August 14, 2018 of ongoing unpermitted construction activities in and around Thomas Creek. Thomas Creek conveys waters of the State of Nevada to the Truckee River, which is a Waters of the U.S. The Division requires that any work being conducted in or near a waterway be permitted for the construction activities. In this case a working in waterways permit, construction stormwater permit and a 401 Water Quality Certification or waiver will be required. Additional permits may also be required by other agencies. Construction in a waterway without a permit is in direct violation of NRS 445A.465.

Therefore, the Division requires Randy & Kami Soule to complete the following:

1. Immediately cease and desist from any and all construction activities in and around Thomas Creek until such time as all required permits are obtained.
2. By September 14, 2018 submit permit applications for a Construction Stormwater and Working in Waterways permit required by the Division for the construction activities located on any and all parcels owned by Randy and Kami Soule that border Thomas Creek.
3. By September 14, 2018 obtain a 401 Water Quality Certification or waiver from the Division, Bureau of Water Quality Planning.
4. Within 21 days of obtaining permit coverage, complete all bank stabilization and installation of BMPs as required in the permits.

5. Please contact the following agencies to inquire about the permit application process and what permits are required for your construction activities.
 - a. Division - Bureau of Water Pollution Control permits branch supervisor Donette Barreto 775-687-9414) and Andrew Dixon, Stormwater Branch 775-687-9422.
 - b. Division – Bureau of Water Quality Planning, Jeanmarie Stone 775-687-9456.

The Division takes this violation seriously. If construction on the properties that borders Thomas Creek continues without obtaining the required permit or permits, **this failure to comply will result in the direct referral of this matter to Formal Enforcement Proceedings which can lead to penalties of up to \$25,000 per day for every item of noncompliance.**

If there are any questions, please contact me at (775) 687-9435.

Sincerely,



Katrina Pascual, P.E., Supervisor
Technical, Compliance and Enforcement
Bureau of Water Pollution Control

CC:

Washoe County Planning Department, PO Box 11130, Reno, NV 89520

ECC:

Andrew Dixon, NDEP
Ryan Fahey, NDEP
Jeanmarie Stone, NDEP
Donette Barreto, NDEP



WASHOE COUNTY

COMMUNITY SERVICES DEPARTMENT

Engineering and Capital Projects

1001 EAST 9TH STREET
PO BOX 11130
RENO, NEVADA 89520-0027
PHONE (775) 328-3600
FAX (775) 328.3699

Date: September 17, 2018

To: Julie Olander, Planner, Planning and Building Division

From: Walter West, P.E., Engineering and Capitol Projects Division

Re: Special Use Permit for Soule Grading - WSUP18-0017
APN 049-165-06 & 07

GENERAL PROJECT DISCUSSION

Washoe County Engineering and Capital Project staff has reviewed the above referenced application. The SUP is for the legalization of unpermitted clearing & grubbing and grading within the Thomas Creek Critical Stream Zone and within a significant hydrological resource. The Engineering and Capital Projects Division recommends approval with the following comments and conditions of approval which supplement applicable County Code and are based upon our review of the application prepared by the applicant. The County Engineer shall determine compliance with all the following conditions of approval.

For questions related to sections below, please see the contact name provided.

GENERAL CONDITIONS (COUNTY CODE 110.438)

Contact Information: Walter West, P.E. (775) 328-2310

1. A complete set of construction improvement drawings, including an on-site grading plan, shall be submitted when applying for a building/grading permit. Grading shall comply with best management practices (BMP's) and shall include detailed plans for grading, site drainage, erosion control (including BMP locations and installation details), slope stabilization, and mosquito abatement. Placement or removal of any excavated materials shall be indicated on the grading plan. Silts shall be controlled on-site and not allowed onto adjacent property.
2. Prior to the approval of a grading permit the applicant shall obtain all required state and federal permits, including but not limited to Nevada Division of Environmental Protection's Working in Waterways Permit, Construction Stormwater Permit, 401 Water Quality Certification (or waiver) and U.S. Army Corps of Engineers 404 permit. Copies of all permits shall be provided to Washoe County Engineering.
3. Prior to the approval of the grading permit, the applicant shall demonstrate that the Cease and Desist order or enforcement cases initiated by Nevada Division of Environmental Protection and the U.S. Army Corps of Engineers (SPK-2018-00705) have been or will be satisfied with the scope of work identified in the grading permit plans.



INTEGRITY



EFFECTIVE
COMMUNICATION



QUALITY
PUBLIC SERVICE

Subject: Soule Grading - WSUP18-0017
Date: September 17, 2018
Page: 2

4. The Truckee Meadows Regional Stormwater Quality Management Program Construction Permit Submittal Checklists and Inspection Fee shall be submitted with the grading permit.
5. A construction estimate shall be prepared by a licensed engineer for the work required to restore the disturbed areas and a financial assurance shall be provided in the amount approved by Washoe County Engineering. The financial assurance shall be returned upon establishment of vegetation to the satisfaction of NDEP, NDF, and Washoe County.
6. Cross-sections indicating cuts and fills shall be submitted when applying for a grading permit. Estimated total volumes shall be indicated.
7. All disturbed areas left undeveloped for more than 30 days shall be treated with a dust palliative. Disturbed areas left undeveloped for more than 45 days shall be revegetated. Specifications for revegetation procedure and seed mix shall be prepared by a licensed landscape architect.
8. No fencing is allowed across the drainage easement maintained by Washoe County. Grading permit plan submittal shall accurately reflect the alignment of fencing approved under previous fence permit.
9. There are two areas of proposed grading along the west property line on steep sloping terrain. The application showing the grading of these areas do not provide sufficient detail as to finished grades/slope of land proposed. All proposed grading shall comply with Washoe County Code Article 438.

DRAINAGE (COUNTY CODE 110.416, 110.420, and 110.421)

Contact Information: Walter West, P.E. (775) 328-2310

1. The FEMA 100-year floodplain, floodway and/or shaded X boundaries with associated flood elevations shall appear on the site plan to the satisfaction of the County Engineer. Building permits for structures and fill in these areas shall be in conformance with the Washoe County Code Article 416

TRAFFIC AND ROADWAY (COUNTY CODE 110.436)

Contact Information: Mitch Fink (775) 328-2050

- There are no traffic related conditions of approval.

UTILITIES (County Code 422 & Sewer Ordinance)

Contact Information: Tim Simpson, P.E. (775) 954-4648

- There are no utility related conditions of approval

From: Kristie Black
To: [Olander, Julie](#)
Subject: FW: Soule Grading WSUP18-0017
Date: Thursday, August 30, 2018 11:54:11 AM
Attachments: [image001.jpg](#)
[image002.jpg](#)
[image003.png](#)
[image004.jpg](#)

Hello,

The NDEP Bureau of Water Pollution Control Stormwater Branch would like to recommend that the Soule Grading Special Use Permit include the need for a Construction Stormwater Permit in addition to a Working in Waterways permit. While Pat's comment that a Construction Stormwater permit will be required if disturbance greater than 1 acre is generally correct, the location of this project within ¼ a mile of a tributary to a Water of the US requires a permit regardless of size. If you have any questions please let me know.



Kristie Black
Environmental Scientist III
Bureau of Water Pollution Control
Nevada Division of Environmental Protection
901 S. Stewart St., Ste 4001
Carson City NV 89701
p: 775.687.9429
www.ndep.nv.gov

From: Andrew Dixon
Sent: Monday, August 27, 2018 1:48 PM
To: Katrina Pascual <kpascual@ndep.nv.gov>; Kristie Black <kblack@ndep.nv.gov>
Subject: FW: Soule Grading WSUP18-0017



Andrew Dixon
Stormwater Supervisor
Bureau of Water Pollution Control
Nevada Division of Environmental Protection
901 S. Stewart St., Ste 4001
Carson City NV 89701
p: 775.687.9422 f: 775.687.4684
www.ndep.nv.gov

From: Patrick Mohn
Sent: Friday, August 24, 2018 3:35 PM
To: Andrew Dixon <andrew.dixon@ndep.nv.gov>; Jean Stone <jstone@ndep.nv.gov>
Subject: FW: Soule Grading WSUP18-0017

My response to the Washoe County SUP for Soule. The original request for review will follow in a separate e-mail.



Patrick A. Mohn, M.Sc., P.E.
UIC Compliance Coordinator
Bureau of Water Pollution Control (BWPC)
Nevada Division of Environmental Protection
901 South Stewart Street, Suite 4001
Carson City, NV 89701
p: 775.687.9419 fax: 775.687.4684
pmohn@ndep.nv.gov

From: Patrick Mohn
Sent: Wednesday, August 22, 2018 9:11 AM
To: 'jolander@washoecounty.us' <jolander@washoecounty.us>
Subject: Soule Grading WSUP18-0017

The NDEP was asked to comment on this project. No substantive comments as the project is grading only. Construction Stormwater permit will

be required if disturbance greater than 1 acre. I would recommend the developer check into whether a Working in Waterways permit will also be required.



Patrick A. Mohn, M.Sc., P.E.
UIC Compliance Coordinator
Bureau of Water Pollution Control (BWPC)
Nevada Division of Environmental Protection
901 South Stewart Street, Suite 4001
Carson City, NV 89701
p: 775.687.9419 fax: 775.687.4684
pmohn@ndep.nv.gov

From: Anna Higgins
To: [Olander, Julee](#)
Subject: Re: #WSUP18-0017
Date: Wednesday, September 12, 2018 3:37:43 PM
Attachments: [image004.png](#)
[image005.png](#)
[image006.png](#)
[image007.png](#)
[image008.png](#)
[image009.png](#)
[image010.png](#)
[image011.png](#)

You can state to the satisfaction of NDF. That way we can see what native vegetation comes back naturally before they are required to seed & plant. Thank you, Anna~

On Sep 12, 2018, at 3:17 PM, Olander, Julee
<JOlander@washoecounty.us<<mailto:JOlander@washoecounty.us>>> wrote:

Anna,
Thank you. My question is do you want me to state the condition with specific vegetation or reveg “to the satisfaction of the Division of Forestry?”

<[image004.png](#)>

Julee Olander
Planner|Community Services Department- Planning & Building Division
jolander@washoecounty.us<<mailto:jolander@washoecounty.us>>| Office: 775.328.3627 | Fax:
775.328.6133
PO Box 11130, Reno, NV 89520-0027
1001 E. Ninth St., Bldg A., Reno, NV 89512
<[image005.png](#)><https://www.washoecounty.us/county_news_subscriptions.php>
<[image006.png](#)><<https://twitter.com/washoecounty>> <[image007.png](#)>
<<https://www.facebook.com/washoecounty>> <[image008.png](#)>
<<https://www.washoecounty.us/>>

Connect with us: cMail<<http://www.washoecounty.us/cMail>> |
Twitter<<http://www.twitter.com/washoecounty>> |
Facebook<<http://www.facebook.com/washoecounty>> |
www.washoecounty.us<<http://www.washoecounty.us/>>

Learn more about our wide variety of exciting career opportunities!
WASHOE COUNTY CAREER DISCOVERY DAY
Thursday, September 13, 2018 from 4:00p.m. – 6:00p.m.
Washoe County Administration Complex

From: Anna Higgins [<mailto:ahiggins@forestry.nv.gov>]
Sent: Wednesday, September 12, 2018 12:31 PM
To: Olander, Julee
Subject: #WSUP18-0017

Dear Julee,

I have reviewed the application for the special use permit for grading for Randal & Kami Soule at 13410 & 13430 Welcome Way #WSUP18-0017 and I visited the site where the grading and vegetation removal occurred without a permit.

The vegetation removal and grading that was done by Mr. Soule in the Thomas Creek Critical Stream Zone was not consistent with the landowners claim of removing past flood debris and dead and dying vegetation. Nevada Division of Forestry does not condone the work that was done in and around Thomas Creek in that it is a sensitive perennial creek and there was massive amounts of soil moved, the stream channel was altered, the flood plain was altered, and the majority of riparian vegetation was removed. Nevada Division of Forestry also does not condone the removal of the remaining trees on site. Contrary to Mr. Soule's claims that the remaining trees are diseased and dying, the cottonwoods are healthy, and while the Jeffrey pine trees have been attacked by sequoia pitch moth, these trees are still healthy and only suffer from visual deformities. Mr. Soule's plan to reseed the area with a meadow grass is not consistent with Nevada Division of Forestry's riparian vegetation management recommendations.

Nevada Division of Forestry (NDF) recommends approving the special use permit with specific conditions of revegetating the site with native vegetation. NDF does not recommend reseeding the area with "meadow grass". NDF recommends replanting the area with native black cottonwood and Jeffrey pine trees, riparian shrubs such as woods rose, coyote willow, and pacific willow, and broadcasting a seed mixture that includes big Wyoming sagebrush, rubber rabbitbrush, antelope bitterbrush, palmer penstemon, blue flax, Great Basin wildrye, and Siberian wheatgrass. The amounts of shrub and tree plantings and the pounds per acre of the seed mix will be defined by NDF as part of the Special Use Permit.

Also, the remaining trees should not be cut down. A healthy and functioning stream zone needs the presence of diverse and native shrubs and trees. The pond that was built in the creek should be removed so that the natural channel is restored. This restoration work should occur before the winter moisture comes which could cause erosion of the disturbed soils into Thomas Creek.

If you need any further advice or guidance on what plants and seeds should be put back on site please let me know. Thank you. Sincerely, Anna~

<image009.png><<http://forestry.nv.gov/>>

<image010.png>Anna Higgins
Resource Management Officer
885 Eastlake Blvd. Carson City, NV 89704
Office (775) 849-2500 ext. 237 Cell (775) 600-5798
ahiggins@forestry.nv.gov<mailto:ahiggins@forestry.nv.gov> - <http://forestry.nv.gov/>

<image011.png><<https://www.facebook.com/Nevada-Division-of-Forestry-447867818630203/>> The Nevada Division of Forestry provides professional natural resource and wildland fire services to conserve and protect forest, rangeland and watershed values.

From: Mark Freese
To: [Olander, Julee](#)
Subject: RE: August Agency Review Memo
Date: Thursday, September 06, 2018 9:44:02 AM
Attachments: [image006.jpg](#)
[image007.png](#)
[image008.png](#)
[image009.png](#)
[image010.png](#)
[image011.png](#)

Thanks would be fine. Thank you Julee!

Mark Freese, Habitat Biologist
Nevada Department of Wildlife
1100 Valley Road
Reno, Nevada 89512
(775) 688-1145
markfreese@ndow.org

Support Nevada's Wildlife...Buy a Hunting and Fishing License

State of Nevada Confidentiality Disclaimer: This message is intended only for the named recipient. If you are not the intended recipient you are notified that disclosing, copying, distributing or taking any action in reliance on the contents of this information is strictly prohibited.

From: Olander, Julee [mailto:JOlander@washoecounty.us]
Sent: Thursday, September 6, 2018 9:18 AM
To: Mark Freese <markfreese@ndow.org>
Subject: RE: August Agency Review Memo

Mark,

Thank you for your email. Can I make these conditions to the special use permit and for you to be the contact person?



Julee Olander

Planner | Community Services Department- Planning & Building Division

jolander@washoecounty.us | Office: 775.328.3627 | Fax: 775.328.6133

PO Box 11130, Reno, NV 89520-0027

1001 E. Ninth St., Bldg A., Reno, NV 89512



Connect with us: [cMail](#) | [Twitter](#) | [Facebook](#) | www.washoecounty.us

Learn more about our wide variety of exciting career opportunities!

WASHOE COUNTY CAREER DISCOVERY DAY

Thursday, September 13, 2018 from 4:00p.m. – 6:00p.m.

Washoe County Administration Complex

From: Mark Freese [<mailto:markfreese@ndow.org>]
Sent: Wednesday, September 05, 2018 4:37 PM
To: Olander, Julee
Subject: RE: August Agency Review Memo

Ms. Olander,

We don't have any major concerns but would recommend standard using Best Management Practices when doing further dirt work (e.g. sediment control devices). We also support reseeding to help minimize erosion issues and recommend installing some coir logs on the exposed banks at water line to help vegetation establish.

Thank you,
Mark

From: Fagan, Donna [<mailto:DFagan@washoecounty.us>]
Sent: Monday, August 20, 2018 3:52 PM
To: Mark Freese <markfreese@ndow.org>
Subject: August Agency Review Memo

Mark,

Please find the attached Agency Review Memo with cases received this month by CSD, Planning and Building.

You've been asked to review item #5. Click on the highlighted item descriptions for a link to the application.

Please send any comments or conditions to the planner for that item.

Thank you,
Donna



Donna Fagan

Planning and Building Division | Community Services Department

dfagan@washoecounty.us | Office: 775.328.3616

1001 E. 9th Street, Reno, NV 89521



Learn more about our wide variety of exciting career opportunities!

WASHOE COUNTY CAREER DISCOVERY DAY

Thursday, September 13, 2018 from 4:00p.m. – 6:00p.m.

Washoe County Administration Complex

From: [Lowden, Joanne](#)
To: [Olander, Julee](#)
Cc: [Wallace-Barnum Colleen](#)
Subject: RE: Thomas Creek access
Date: Wednesday, September 12, 2018 3:45:56 PM
Attachments: [image006.gif](#)
[image007.png](#)
[image008.png](#)
[image009.png](#)
[image010.png](#)
[image011.png](#)

Hi Julee,

Let's change the conditions as follows:

1. Monitor and treat invasive weeds in the disturbance area for the life of the project. Ensure that any mulch, straw, or other materials used for erosion control are certified weed-free.
2. Work with the Nevada Division of Forestry (NDF) to develop a re-vegetation plan that is consistent with their riparian vegetation management recommendations. The re-vegetation plan should include the planting/seeding of native riparian plant species in the riparian buffer along both sides of Thomas Creek.

[Joanne Lowden](#)

Natural Resource Planner | Washoe County Community Services Department-Parks
p 775.328-2039 | f 775.829.8014

Physical Address: 1001 E. 9th Street, Reno NV 89512
P.O. Box 11130 | Reno, NV 89520

www.washoecountyparks.com

 Please consider the environment before printing this e-mail



From: Olander, Julee
Sent: Wednesday, September 12, 2018 3:22 PM
To: Lowden, Joanne
Cc: Wallace-Barnum Colleen
Subject: RE: Thomas Creek access

Joanne,

I'm going to forward the email I just got from the Division of Forestry. Your comments are similar - let me know what you want to do.



Julee Olander

Planner | Community Services Department- Planning & Building Division

jolander@washoecounty.us | Office: 775.328.3627 | Fax: 775.328.6133

PO Box 11130, Reno, NV 89520-0027

1001 E. Ninth St., Bldg A., Reno, NV 89512



Connect with us: [cMail](#) | [Twitter](#) | [Facebook](#) | [www.washoecounty.us](#)

Learn more about our wide variety of exciting career opportunities!

WASHOE COUNTY CAREER DISCOVERY DAY

Thursday, September 13, 2018 from 4:00p.m. – 6:00p.m.

Washoe County Administration Complex

From: Lowden, Joanne
Sent: Wednesday, September 12, 2018 12:58 PM
To: Olander, Julee
Cc: Wallace-Barnum Colleen
Subject: RE: Thomas Creek access

Hi Julee,

Per our earlier conversation, it sounds like the landowner is unwilling to work with us on re-establishing the trail. I would still like to pursue the potential for having this as a condition of approval for the permit, depending on further guidance from Nate. Here are the other conditions that I would like to see attached to the permit:

1. Monitor and treat invasive weeds in the disturbance area for the life of the project. Ensure that any mulch, straw, or other materials used for erosion control are certified weed-free.
2. The re-vegetation plan should include the planting/seeding of native riparian plant species in the riparian buffer along both sides of Thomas Creek. Riparian stabilizer plants (i.e. willows, sedges, rushes, etc.) with dense, strong, and deep root systems effective in binding soil and preventing erosion are preferred for re-vegetation within the riparian buffer.

Thanks,

Joanne Lowden

Natural Resource Planner | Washoe County Community Services Department-Parks

p 775.328-2039 | f 775.829.8014

Physical Address: 1001 E. 9th Street, Reno NV 89512

P.O. Box 11130 | Reno, NV 89520

www.washoecountyparks.com

 Please consider the environment before printing this e-mail



From: Olander, Julee
Sent: Wednesday, September 12, 2018 10:22 AM
To: Randy Soule
Cc: Lloyd, Trevor; Edwards, Nathan; Wallace-Barnum Colleen; Lowden, Joanne
Subject: Thomas Creek access

Randy,

Wanted to send you an email concerning access along Thomas Creek. At the CAB meeting you stated that you would work with Washoe County Parks on providing access to Thomas Creek. I'm suggesting that it be a conditional of approval for the special use permit, that you work with Park staff to develop and re-establish the trail that has been along the creek for many years. If you have another idea let me know.

Thank you,



Julee Olander

Planner | Community Services Department- Planning & Building Division

jolander@washoecounty.us | Office: 775.328.3627 | Fax: 775.328.6133

PO Box 11130, Reno, NV 89520-0027

1001 E. Ninth St., Bldg A., Reno, NV 89512



Connect with us: [cMail](#) | [Twitter](#) | [Facebook](#) | www.washoecounty.us

Learn more about our wide variety of exciting career opportunities!

WASHOE COUNTY CAREER DISCOVERY DAY

Thursday, September 13, 2018 from 4:00p.m. – 6:00p.m.

Washoe County Administration Complex

From: [O'Connor, Tim](#)
To: [Olander, Julee](#)
Subject: Special Use Permit Case Number WSUP18-0017 (Soule Grading) –
Date: Monday, August 20, 2018 4:29:02 PM

Julee,

With regard to the Special Use Permit Case Number WSUP18-0017 (Soule Grading), the Washoe County Sheriff's Office Patrol Division has no issues or concerns.

Captain Tim O'Connor
Washoe County Sheriff's Office
Patrol Division
775-328-3354
PRIDE - Professionalism, Respect, Integrity, Dedication, Equality

From: Steve Shell
To: [Olander, Julee](#)
Subject: FW: August Agency Review Memo
Date: Monday, August 20, 2018 4:20:36 PM
Attachments: [image001.png](#)
[image002.png](#)
[image003.png](#)
[image004.png](#)
[image005.png](#)
[August Agency Review Memo.pdf](#)

The subject properties lie within the greater TMWA service area. Thomas Creek, a decreed water source, runs across the property. The point of diversion and place of use of Permit 72166, Certificate 18258 (surface water), and Permits 80350 and 80351 (underground water) are appurtenant to APN's 049-165-05 and 049-165-06. These permits are owned by the owner of record of the properties, Randall and Kami Soule.

Steve Shell
Water Resources Specialist II
Division of Water Resources
775-684-2836

From: Fagan, Donna <DFagan@washoecounty.us>
Sent: Monday, August 20, 2018 3:51 PM
To: Steve Shell <sshell@water.nv.gov>
Subject: August Agency Review Memo

Hi Steve,

Please find the attached Agency Review Memo with cases received this month by CSD, Planning and Building.

You've been asked to review item #5. Click on the highlighted item descriptions for a link to the application.

Please send any comments or conditions to the planner for that item.

Thank you,
Donna



Donna Fagan
Planning and Building Division | Community Services Department
dfagan@washoecounty.us | Office: 775.328.3616
1001 E. 9th Street, Reno, NV 89521

Learn more about our wide variety of exciting career opportunities!

WASHOE COUNTY CAREER DISCOVERY DAY

Thursday, September 13, 2018 from 4:00p.m. – 6:00p.m.

WSUP18-0017
EXHIBIT G

Washoe County Administration Complex



WASHOE COUNTY
COMMUNITY SERVICES
INTEGRITY COMMUNICATION SERVICE

P.O. Box 11130
Reno, Nevada 89520-0027
Phone: (775) 328-3600
Fax: (775) 328-3699

August 20, 2018

TO: Julee Olander, Planner, CSD, Planning & Building Division
FROM: Vahid Behmaram, Water Management Planner Coordinator, CSD
SUBJECT: Special Use Permit Case Number WSUP18-0017 (Soule Grading)

Project description:

The applicant is requesting to approve a special use permit for grading, which was performed without the required permit(s) within a significant hydrological resource (SHR), by grading and removing vegetation within the Thomas Creek Critical Stream Zone.

Location: 13410 & 13430 Welcome Way, Assessor's Parcel Numbers: 049-165-06 and 049-165-07, Parcel Size: 2.77 and 2.40 acres.

The Community Services Department (CSD) recommends approval of this project with the following comments and Water Rights conditions:

There are no water rights conditions or comments for approval of the proposed Special Use Permit.

From: [Beaver, Lisa](#)
To: [Olander, Julee](#)
Subject: RE: Soule Grading question
Date: Wednesday, September 19, 2018 10:19:30 AM

That is correct, there is "currently" no requirement. I am working on a weed abatement requirement for property without buildings or structures, but this will not be in effect until 2019.

Thank you,

Lisa

-----Original Message-----

From: Olander, Julee
Sent: Wednesday, September 19, 2018 9:39 AM
To: Beaver, Lisa
Subject: RE: Soule Grading question

Lisa,

There are no buildings on the property, the permit is for a fence around vacant property. Does that mean TMFPD does not require a 6 foot defensible space around the property with no buildings?

Thanks,

Julee Olander
Planner|Community Services Department- Planning & Building Division
jolander@washoecounty.us | Office: 775.328.3627 | Fax: 775.328.6133
PO Box 11130, Reno, NV 89520-0027
1001 E. Ninth St., Bldg A., Reno, NV 89512

Connect with us: [cMail](#) | [Twitter](#) | [Facebook](#) | www.washoecounty.us

-----Original Message-----

From: Beaver, Lisa
Sent: Wednesday, September 19, 2018 9:26 AM
To: Olander, Julee
Subject: RE: Soule Grading question

Good morning Julee,

It would appear on the documentation attached there is no reference to any buildings or structures. Defensible space shall be maintained around buildings and structures as required by the 2012 IWUIC section 604. Currently Washoe County nor Truckee Meadows Fire Protection District does not have a weed abatement standard so therefore clearance from property line is not required from a defensible space issue.

If I am incorrect in regards to the building or structure statement, please let me know.

Thanks,

Lisa

Lisa M. Beaver, PE, CFM, CBO
Deputy Fire Chief | Truckee Meadows Fire Protection District

lbeaver@tmfpd.us |direct (775) 326-6006 cell (775)313-1592 | 1001 E. Ninth St., Bldg. D, Reno, NV 89512

”Committed to excellence, service, and the protection of life and property in our community”

-----Original Message-----

From: Olander, Julee

Sent: Wednesday, September 19, 2018 8:47 AM

To: Beaver, Lisa

Subject: Soule Grading question

Lisa,

Sorry I missed you yesterday. Have attached the plans in questioned and have highlighted the comment. Please let me know if this is a TMTPD requirement or not.

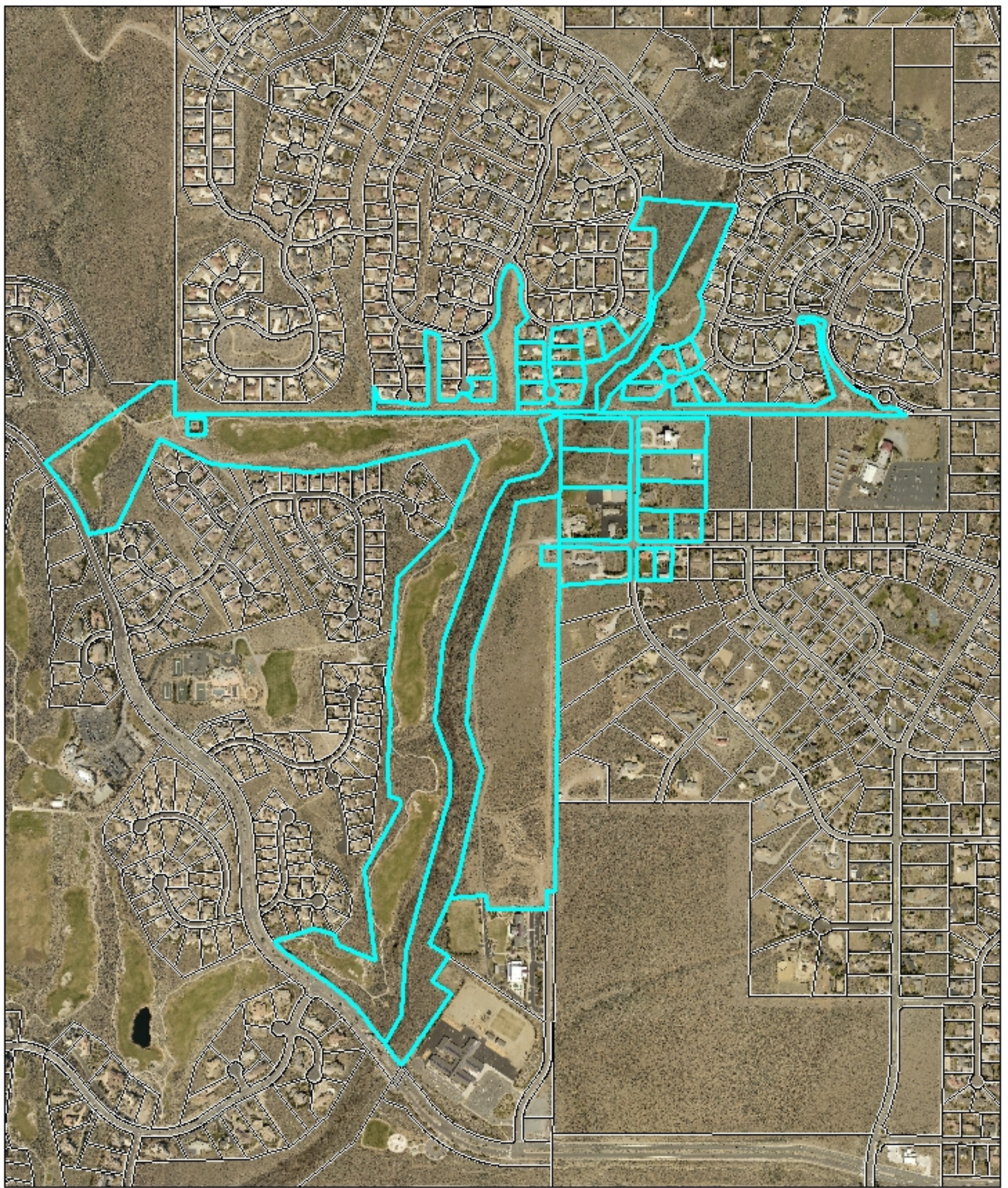
Thanks,

Julee Olander

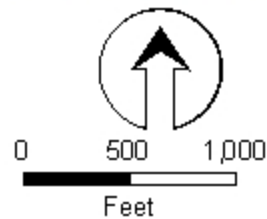
Planner|Community Services Department- Planning & Building Division

jolander@washoecounty.us| Office: 775.328.3627 | Fax: 775.328.6133 PO Box 11130, Reno, NV 89520-0027

1001 E. Ninth St., Bldg A., Reno, NV 89512



WSUP18-0017(Soule Grading)
Noticing Map
35 parcels within 500 feet of project site



Date : October 2018

Community Services
Department



**WASHOE COUNTY
NEVADA**

Post Office Box 11100
Reno, Nevada 89507

Source : Planning and Building Division

WSUP18-0017

EXHIBIT H

Randy Soule

From: Randy Soule
Sent: Monday, June 25, 2018 2:08 PM
To: Farmer, Brian; Hauenstein, Mojra
Cc: Webb, Bob; Chism, Johnna; Mike Burgess
Subject: RE: 13430 Welcome Way post meeting pictures and agreement

Mojra, Bob and Brian;

I wanted to memorialize the understanding of our meeting last Thursday regarding the subject property on Welcome Way. As agreed, I did meet with Brian at the site on Friday to review the remaining debris, trash, slash piles and scope of the surface disturbance, which Brian has provided the attached pictures.

As discussed at the meeting, we object to the need and requirement to obtain a special use grading permit because the work falls under the Allowed Use provisions of the WC Code section 418. However, the County feels in their opinion that we have exceeded the Allowable-Use of section 418. In the spirit of cooperation and to avoid further proceedings and adversarial arguments, both the owner and County have agreed to proceed as follows:

1. The owner will submit for and obtain a grading Special-Use permit for the work requested. The County will assist the owner with filling out the application for the permit and the information needed. And, the County will work with the owner on the charged fees for the permit.
2. To avoid adverse site conditions of fire, flooding, and erosion the County will allow the owner to proceed to complete only the following until the Special-Use permit is obtained:
 - a. Removal and disposal of the slash piles from the site.
 - b. Removal of the remaining debris/trash that was reviewed with Brian.
 - c. Re-planting of the disturbed area with meadow grass and a soil stabilizer.

We will retain a civil engineer and proceed with the Special use permit application this week. Hopefully we can have this permit application ready for submittal within a few weeks depending on how long it takes to complete the drawings and other required information.

Please respond with your same understanding of the above, so we can proceed accordingly. Thank you.

Randy Soule



14830 Kivett Lane
Reno, NV 89521
Ofc (775) 852-2295
Cell (775) 762-2797
Fax (775) 852-9455

From: Farmer, Brian [mailto:BFarmer@washoecounty.us]
Sent: Friday, June 22, 2018 2:20 PM
To: Randy Soule <Randy@encorenv.com>; Hauenstein, Mojra <MHauenstein@washoecounty.us>
Cc: Webb, Bob <bwebb@washoecounty.us>; Chism, Johnna <JChism@washoecounty.us>
Subject: 13430 Welcome Way post meeting pictures and agreement



WSUP18-0017
EXHIBIT I











WSUP18-0017
EXHIBIT I



WSUP18-0017
EXHIBIT 1







~~ATT~~
~~OFFICE~~

Community Services Department

Planning and Building

SPECIAL USE PERMIT

(see page 5)



SPECIAL USE PERMIT FOR GRADING

(see page 11)

SPECIAL USE PERMIT FOR STABLES

(see page 16)

APPLICATION



Community Services Department
Planning and Building
1001 E. Ninth St., Bldg. A
Reno, NV 89520

Telephone: 775.328.6100

Washoe County Development Application

Your entire application is a public record. If you have a concern about releasing personal information, please contact Planning and Building staff at 775.328.6100.

Project Information		Staff Assigned Case No.: _____	
Project Name: <u>SOULE PROPERTY CLEANUP</u>			
Project Description: <u>REMOVAL AND CLEANUP OF DEBRIS, TRASH, DEAD OR DYEING VEGETATION FROM 2017 FLOODING. INCLUDES RE-PLANTING OF GRA.</u>			
Project Address: <u>13430 WELCOME WAY</u>			
Project Area (acres or square feet): <u>2.5 AC</u>			
Project Location (with point of reference to major cross streets AND area locator): <u>NORTH-WEST END OF WELCOME WAY</u>			
Assessor's Parcel No.(s):	Parcel Acreage:	Assessor's Parcel No.(s):	Parcel Acreage:
<u>049-165-07</u>	<u>4 AC</u>		
<u>049-165-06</u>	<u>2.5 AC</u>		
Section(s)/Township/Range:			
Indicate any previous Washoe County approvals associated with this application: Case No.(s). <u>NONE</u>			
Applicant Information (attach additional sheets if necessary)			
Property Owner:		Professional Consultant:	
Name: <u>RANDY & KAMI SOULE</u>		Name:	
Address: <u>13370 WELCOME WAY</u>		Address:	
Zip: <u>89511</u>		Zip:	
Phone: <u>762-2777</u> Fax:		Phone: Fax:	
Email: <u>RANDY@ENCORENV.COM</u>		Email:	
Cell: <u>SAME</u> Other:		Cell: Other:	
Contact Person: <u>SAME</u>		Contact Person:	
Applicant/Developer: <u>N/A</u>		Other Persons to be Contacted: <u>NONE</u>	
Name:		Name:	
Address:		Address:	
Zip:		Zip:	
Phone: Fax:		Phone: Fax:	
Email:		Email:	
Cell: Other:		Cell: Other:	
Contact Person:		Contact Person:	
For Office Use Only			
Date Received:	Initial:	Planning Area:	
County Commission District:		Master Plan Designation(s):	
CAB(s):		Regulatory Zoning(s):	

July 1, 2017

Property Owner Affidavit

Applicant Name: RANDY SOULE

The receipt of this application at the time of submittal does not guarantee the application complies with all requirements of the Washoe County Development Code, the Washoe County Master Plan or the applicable area plan, the applicable regulatory zoning, or that the application is deemed complete and will be processed.

STATE OF NEVADA)
COUNTY OF WASHOE)

I, RANDY SOULE (please print name)

being duly sworn, depose and say that I am the owner* of the property or properties involved in this application as listed below and that the foregoing statements and answers herein contained and the information herewith submitted are in all respects complete, true, and correct to the best of my knowledge and belief. I understand that no assurance or guarantee can be given by members of Planning and Building.

(A separate Affidavit must be provided by each property owner named in the title report.)

Assessor Parcel Number(s): 049-165-07 AND 049-165-06

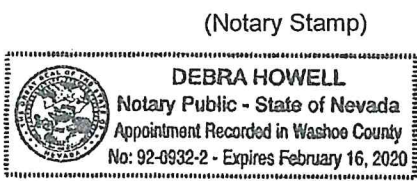
Printed Name RANDY SOULE

Signed [Signature]

Address 13370 WELCOME WAY
RENO, NV 89511

Subscribed and sworn to before me this 26th day of June, 2018.

[Signature]
Notary Public in and for said county and state
My commission expires: Feb 16, 2020



*Owner refers to the following: (Please mark appropriate box.)

- Owner
 Corporate Officer/Partner (Provide copy of record document indicating authority to sign.)
 Power of Attorney (Provide copy of Power of Attorney.)
 Owner Agent (Provide notarized letter from property owner giving legal authority to agent.)
 Property Agent (Provide copy of record document indicating authority to sign.)
 Letter from Government Agency with Stewardship

Property Owner Affidavit

Applicant Name: RANDY SOULE

The receipt of this application at the time of submittal does not guarantee the application complies with all requirements of the Washoe County Development Code, the Washoe County Master Plan or the applicable area plan, the applicable regulatory zoning, or that the application is deemed complete and will be processed.

STATE OF NEVADA)
)
COUNTY OF WASHOE)

I, KAMI SOULE
(please print name)

being duly sworn, depose and say that I am the owner* of the property or properties involved in this application as listed below and that the foregoing statements and answers herein contained and the information herewith submitted are in all respects complete, true, and correct to the best of my knowledge and belief. I understand that no assurance or guarantee can be given by members of Planning and Building.

(A separate Affidavit must be provided by each property owner named in the title report.)

Assessor Parcel Number(s): 049-165-07 AND 049-165-06

Printed Name KAMI SOULE

Signed Kami Soule

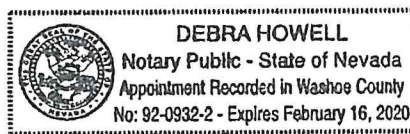
Address 13390 WELCOME WAY
RENO NV 89511

Subscribed and sworn to before me this
24th day of July, 2018.

Debra Howell
Notary Public in and for said county and state

My commission expires: Feb 16, 2020

(Notary Stamp)



*Owner refers to the following: (Please mark appropriate box.)

- Owner
- Corporate Officer/Partner (Provide copy of record document indicating authority to sign.)
- Power of Attorney (Provide copy of Power of Attorney.)
- Owner Agent (Provide notarized letter from property owner giving legal authority to agent.)
- Property Agent (Provide copy of record document indicating authority to sign.)
- Letter from Government Agency with Stewardship

July 1, 2017

**Special Use Permit Application
for Grading
Supplemental Information**

(All required information may be separately attached)

Chapter 110 of the Washoe County Code is commonly known as the Development Code. Specific references to special use permits may be found in Article 810, Special Use Permits. Article 438, Grading, and Article 418, Significant Hydrologic Resources, are the ordinances specifically involved in this request.

1. What is the purpose of the grading?

TO CLEAN-UP THE SITE FROM SEVERAL HARSH WINTERS AND THE 2017 FLOODING, WHICH REQUIRED THE REMOVAL OF TRASH, DEBRIS, DEAD AND DYEING VEGETATION. IT IS ANTICIPATED THAT SIMILAR CLEANUP WILL BE REQUIRED ANNUALLY.

2. How many cubic yards of material are you proposing to excavate on site?

NONE

3. How many square feet of surface of the property are you disturbing?

≈ 8000 sq ft ON PARCEL 047-165-07
≈ 6000 sq ft ON PARCEL 049-165-06

4. How many cubic yards of material are you exporting or importing? If none, how are you managing to balance the work on-site?

NONE
THE EXISTING LAND CONTOURS WILL STAY THE SAME

5. Is it possible to develop your property without surpassing the grading thresholds requiring a Special Use Permit? (Explain fully your answer.)

YES. THE GRADING THRESHOLDS ARE NOT EXCEEDED. BUT, DUE TO THE NATURE OF THE WORK ALONG THE STREAM ZONE, THE COUNTY DEMANDED A SPECIAL USE PERMIT, WHICH WAS OPPOSED BY THE OWNER WHO HAS AGREED TO SUBMIT.

6. Has any portion of the grading shown on the plan been done previously? (If yes, explain the circumstances, the year the work was done, and who completed the work.)

YES. IN \approx 2000 THE ARROWCREEK DEVELOPER CUT IN AN ACCESS ROAD THAT WAS USED FOR THE CREEK BRIDGE PROJECT.

7. Have you shown all areas on your site plan that are proposed to be disturbed by grading? (If no, explain fully your answer.)

YES

8. Can the disturbed area be seen from off-site? If yes, from which directions, and which properties or roadways?

No

9. Could neighboring properties also be served by the proposed access/grading requested (i.e. if you are creating a driveway, would it be used for access to additional neighboring properties)?

No

10. What is the slope (Horizontal/Vertical) of the cut and fill areas proposed to be? What methods will be used to prevent erosion until the revegetation is established?

NO CUT OR FILL IS PLANNED
EROSION WADDLES ~~WILL~~ ^{HAVE} BEEN PLACED PARALLEL TO THE STREAM.
THE AREA DISTURBED WILL BE SPRAY RE-PLANTED WITH MEADOW GRASS SEED THAT WILL INCLUDE AN ORGANIC SOIL STABILIZER.

11. Are you planning any berms?

Yes No If yes, how tall is the berm at its highest?

12. If your property slopes and you are leveling a pad for a building, are retaining walls going to be required? If so, how high will the walls be and what is their construction (i.e. rockery, concrete, timber, manufactured block)?

N/A

13. What are you proposing for visual mitigation of the work?

NONE
THE WORK CANNOT BE SEEN FROM OFFSITE

14. Will the grading proposed require removal of any trees? If so, what species, how many and of what size?

YES.

- APPROX 6 DEAD OR DYING COTTONWOOD TREES THAT ARE 10' to 20' TALL
- APPROX 2 DEAD OR DYING PINE TREES THAT ARE ≈ 20' TALL AND WERE FALLING OVER FROM THE WINDS

15. What type of revegetation seed mix are you planning to use and how many pounds per acre do you intend to broadcast? Will you use mulch and, if so, what type?

16. How are you providing temporary irrigation to the disturbed area?

NATURAL GROUND MOISTURE FROM THE CREEK ZONE SHOULD BE ADEQUATE FOR GROWTH. IF NOT, THE OWNER OWNS SHARE OF CREEK WATER THAT IS OF BENEFICIAL USE TO THIS PROPERTY.

17. Have you reviewed the revegetation plan with the Washoe Storey Conservation District? If yes, have you incorporated their suggestions?

No.

18. Are there any restrictive covenants, recorded conditions, or deed restrictions (CC&Rs) that may prohibit the requested grading?

<input type="checkbox"/> Yes	<input checked="" type="checkbox"/> No	If yes, please attach a copy.
------------------------------	--	-------------------------------

Washoe County Treasurer
Tammi Davis

Washoe County Treasurer
P.O. Box 30039, Reno, NV 89520-3039
ph (775) 328-2510 fax (775) 328-2500
Email: tax@washoecounty.us

Account Detail

[Back to Account Detail](#)

[Change of Address](#)

[Print this Page](#)

Pay Online

No payment due for this account.

\$0.00

Washoe County Parcel Information

Parcel ID	Status	Last Update
04916507	Active	6/27/2018 2:06:27 AM

Current Owner:
SOULE, RANDALL & KAMI

SITUS:
13430 WELCOME WAY
WCTY NV

13390 WELCOME WAY
RENO, NV 89511

Taxing District
4000

Geo CD:

Legal Description

Range 19 SubdivisionName THOMAS CREEK ESTATES 3F Township 18 Section 24 Lot 3 Block

Tax Bill (Click on desired tax year for due dates and further details)

Tax Year	Net Tax	Total Paid	Penalty/Fees	Interest	Balance Due
2017	\$1,097.49	\$1,097.49	\$0.00	\$0.00	\$0.00
2016	\$1,070.09	\$1,070.09	\$0.00	\$0.00	\$0.00
2015	\$1,067.82	\$1,067.82	\$0.00	\$0.00	\$0.00
2014	\$1,034.64	\$1,034.64	\$0.00	\$0.00	\$0.00
2013	\$1,004.46	\$1,004.46	\$0.00	\$0.00	\$0.00
Total					\$0.00

Important Payment Information

- ALERTS:** If your real property taxes are delinquent, the search results displayed may not reflect the correct amount owing. Please contact our office for the current amount due.
- For your convenience, online payment is available on this site. E-check payments are accepted without a fee. However, a service fee does apply for online credit card payments. See Payment Information for details.

Pay By Check

Please make checks payable to:
WASHOE COUNTY TREASURER

Mailing Address:
P.O. Box 30039
Reno, NV 89520-3039

Overnight Address:
1001 E. Ninth St., Ste D140
Reno, NV 89512-2845

Payment Information

Special Assessment District

Installment Date Information

Assessment Information

The Washoe County Treasurer's Office makes every effort to produce and publish the most current and accurate information possible. No warranties, expressed or implied, are provided for the data herein, its use, or its interpretation. If you have any questions, please contact us at (775) 328-2510 or tax@washoecounty.us

This site is best viewed using Google Chrome, Internet Explorer 11, Mozilla Firefox or Safari.

Washoe County Treasurer
Tammi Davis

Washoe County Treasurer
P.O. Box 30039, Reno, NV 89520-3039
ph. (775) 328-2510 fax: (775) 328-2500
Email: tax@washoecounty.us

Account Detail

[Back to Account Detail](#)

[Change of Address](#)

[Print this Page](#)

Washoe County Parcel Information

Parcel ID	Status	Last Update
04916506	Active	6/27/2018 2:06:27 AM

Current Owner:
SOULE, RANDY & KAMI

13390 WELCOME WAY
RENO, NV 89511

SITUS:
13410 WELCOME WAY
WCTY NV

Taxing District
4000

Geo CD:

Legal Description

Range 19 SubdivisionName THOMAS CREEK ESTATES 3F Township 18 Section Lot 2 Block

Tax Bill (Click on desired tax year for due dates and further details)

Tax Year	Net Tax	Total Paid	Penalty/Fees	Interest	Balance Due
2017	\$1,145.14	\$1,145.14	\$0.00	\$0.00	\$0.00
2016	\$1,116.53	\$1,116.53	\$0.00	\$0.00	\$0.00
2015	\$1,114.18	\$1,114.18	\$0.00	\$0.00	\$0.00
2014	\$1,079.56	\$1,079.56	\$0.00	\$0.00	\$0.00
2013	\$1,048.08	\$1,048.08	\$0.00	\$0.00	\$0.00
Total					\$0.00

Important Payment Information

- **ALERTS:** If your real property taxes are delinquent, the search results displayed may not reflect the correct amount owing. Please contact our office for the current amount due.
- For your convenience, online payment is available on this site. E-check payments are accepted without a fee. However, a service fee does apply for online credit card payments. See Payment Information for details.

Pay Online

No payment due for this account.

\$0.00

Pay By Check

Please make checks payable to:
WASHOE COUNTY TREASURER

Mailing Address:
P.O. Box 30039
Reno, NV 89520-3039

Overnight Address:
1001 E. Ninth St., Ste D140
Reno, NV 89512-2845

Payment Information

Special Assessment District

Installment Date Information

Assessment Information

The Washoe County Treasurer's Office makes every effort to produce and publish the most current and accurate information possible. No warranties, expressed or implied, are provided for the data herein, its use, or its interpretation. If you have any questions, please contact us at (775) 328-2510 or tax@washoecounty.us

This site is best viewed using Google Chrome, Internet Explorer 11, Mozilla Firefox or Safari.

Randy Soule

From: Randy Soule
Sent: Monday, June 25, 2018 2:08 PM
To: Farmer, Brian; Hauenstein, Mojra
Cc: Webb, Bob; Chism, Johnna; Mike Burgess
Subject: RE: 13430 Welcome Way post meeting pictures and agreement

Mojra, Bob and Brian;

I wanted to memorialize the understanding of our meeting last Thursday regarding the subject property on Welcome Way. As agreed, I did meet with Brian at the site on Friday to review the remaining debris, trash, slash piles and scope of the surface disturbance, which Brian has provided the attached pictures.

As discussed at the meeting, we object to the need and requirement to obtain a special use grading permit because the work falls under the Allowed Use provisions of the WC Code section 418. However, the County feels in their opinion that we have exceeded the Allowable-Use of section 418. In the spirit of cooperation and to avoid further proceedings and adversarial arguments, both the owner and County have agreed to proceed as follows:

1. The owner will submit for and obtain a grading Special-Use permit for the work requested. The County will assist the owner with filling out the application for the permit and the information needed. And, the County will work with the owner on the charged fees for the permit.
2. To avoid adverse site conditions of fire, flooding, and erosion the County will allow the owner to proceed to complete only the following until the Special-Use permit is obtained:
 - a. Removal and disposal of the slash piles from the site.
 - b. Removal of the remaining debris/trash that was reviewed with Brian.
 - c. Re-planting of the disturbed area with meadow grass and a soil stabilizer.

We will retain a civil engineer and proceed with the Special use permit application this week. Hopefully we can have this permit application ready for submittal within a few weeks depending on how long it takes to complete the drawings and other required information.

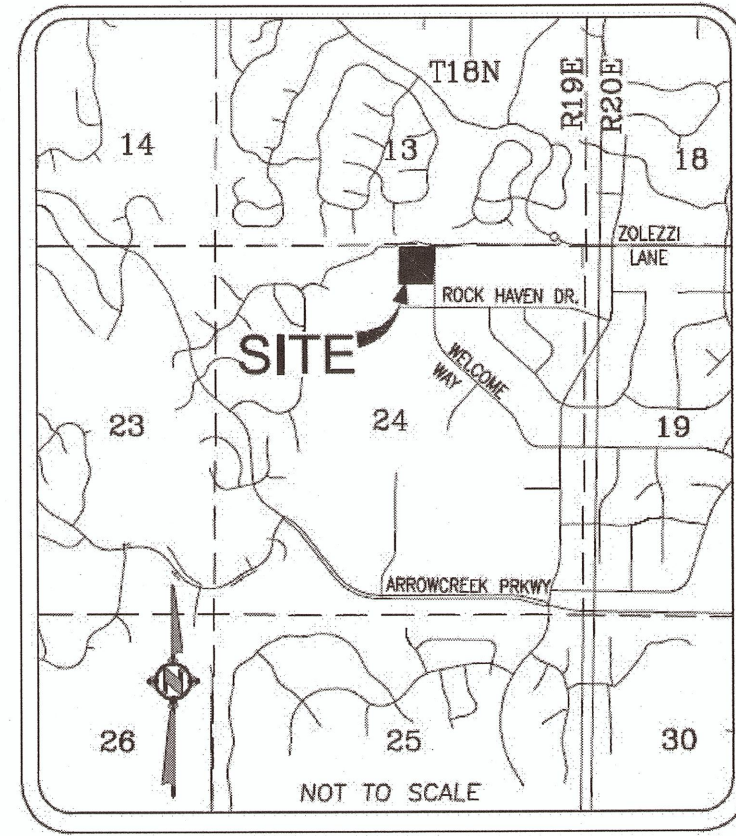
Please respond with your same understanding of the above, so we can proceed accordingly. Thank you.

Randy Soule



14830 Kivett Lane
Reno, NV 89521
Ofc (775) 852-2295
Cell (775) 762-2797
Fax (775) 852-9455

From: Farmer, Brian [mailto:BFarmer@washoecounty.us]
Sent: Friday, June 22, 2018 2:20 PM
To: Randy Soule <Randy@encorenv.com>; Hauenstein, Mojra <MHauenstein@washoecounty.us>
Cc: Webb, Bob <bwebb@washoecounty.us>; Chism, Johnna <JChism@washoecounty.us>
Subject: 13430 Welcome Way post meeting pictures and agreement



VICINITY MAP

GENERAL NOTES

- TOTAL AREA TO BE CLEARED AND GRUBBED ON LOT 049-165-06 +/- 4,736.6 SF ON EAST SIDE OF THOMAS CREEK, +/- 2,736.6 SF ON WEST SIDE OF THOMAS CREEK, ON LOT 049-165-07 +/- 6,001.9 SF ON EAST SIDE OF THOMAS CREEK, +/- 3,596.2 SF ON WEST SIDE OF THOMAS CREEK.
- STOCKPILED DEAD VEGETATION TO BE REMOVED AND PROPERLY DISPOSED OF.
- AREA TO BE RE-SEEDING WILL BE HYDRO-SEEDING WITH A MEADOW GRASS SEED AND ORGANIC SOIL STABILIZER.
- IF IRRIGATION IS REQUIRED FOR GRASS TO ESTABLISH, FLOOD IRRIGATION WILL BE USED (PERMIT #72166).
- FENCE (FUTURE) WILL BE INSTALLED UNDER SEPARATE PERMIT.

APN: 152-021-09

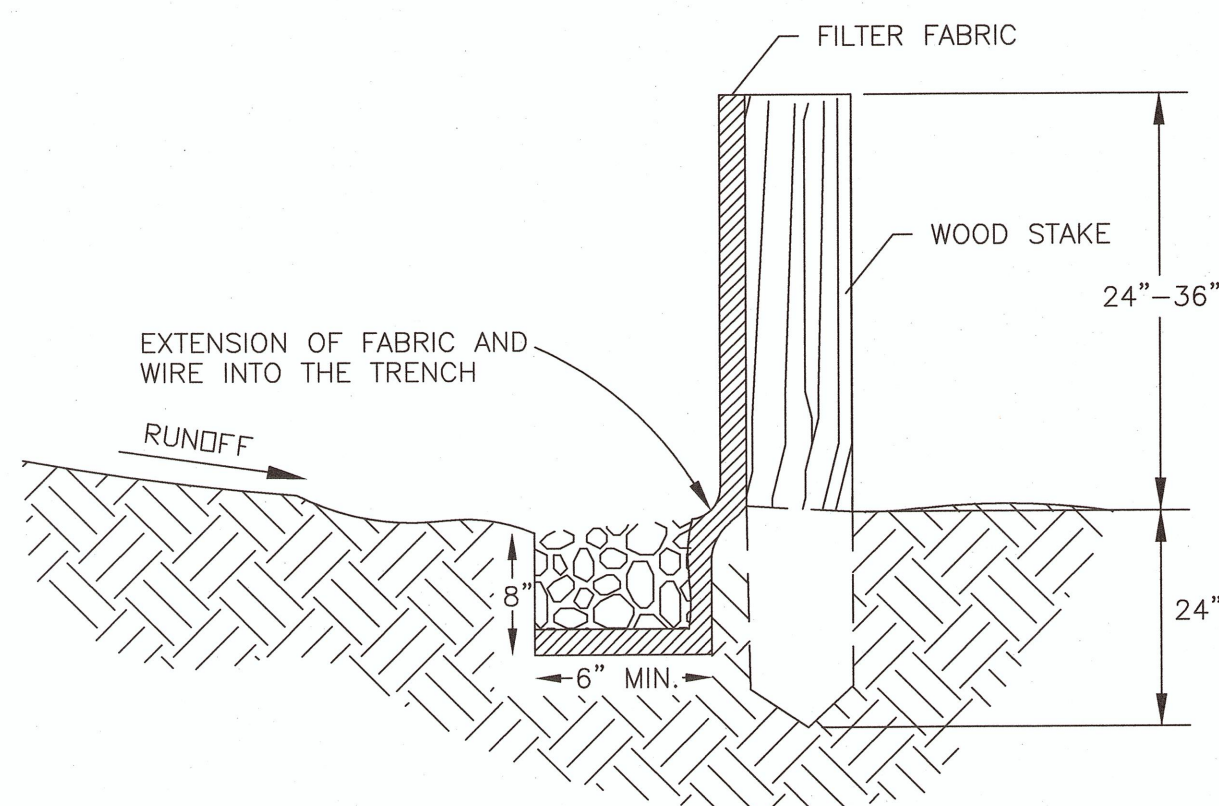
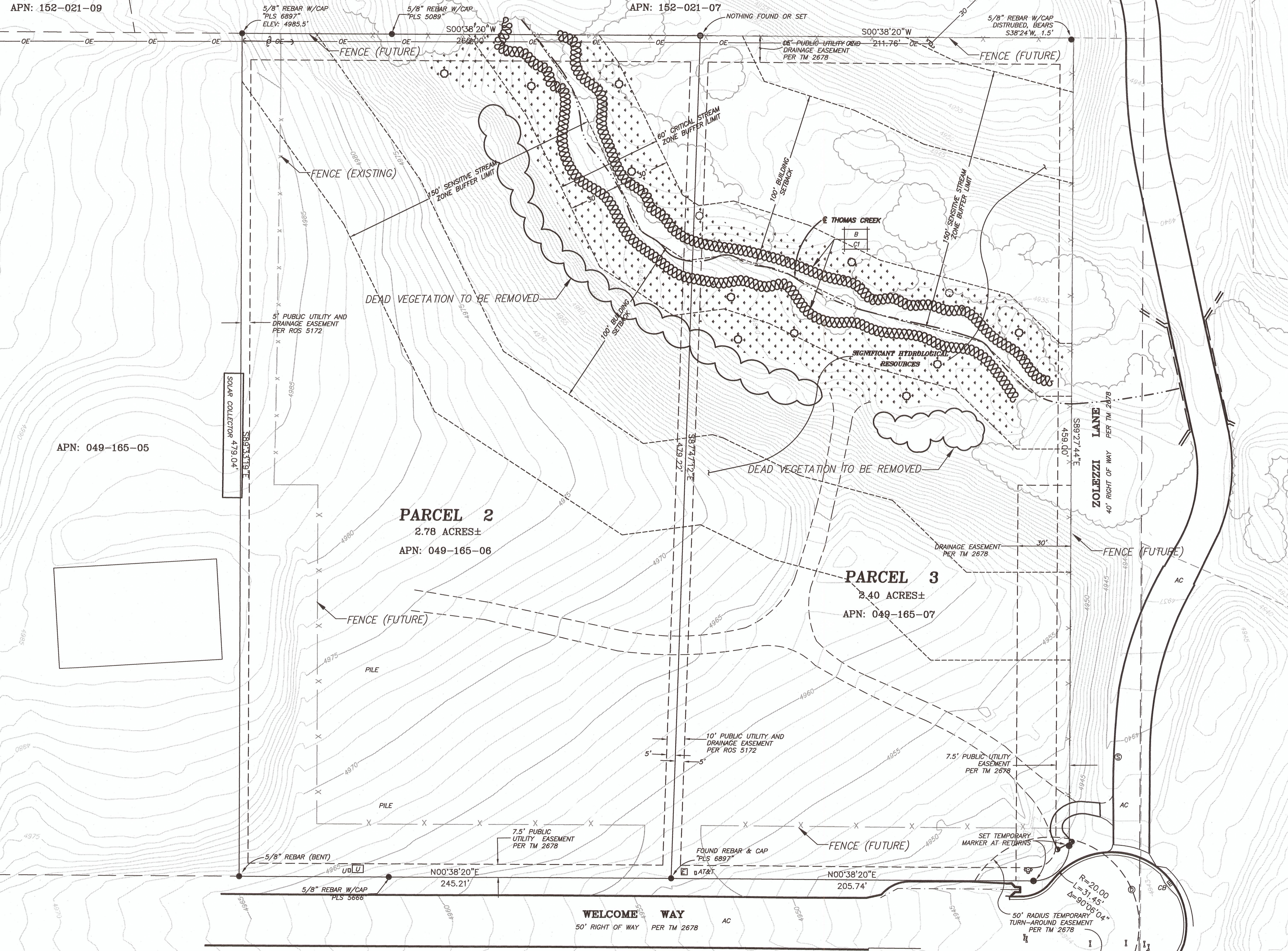
ROCKHAVEN DRIVE

APN: 049-165-05

PARCEL 2
2.78 ACRES±
APN: 049-165-08

PARCEL 3
2.40 ACRES±
APN: 049-165-07

WELCOME WAY
50' RIGHT OF WAY PER TM 2678 AC



NOTES

- SILT FENCE TO BE SUPPORTED BY WOOD OR STEEL POSTS AT 5' ON CENTER SPACING, OR 10' ON CENTER WITH WIRE BACKING.
- GEOTEXTILE (SILT FENCE FABRIC) SHALL EXTEND APPROXIMATELY 8" BELOW GRADE FOR A DISTANCE OF 4"-6" IN THE UPSTREAM DIRECTION. BACKFILL WITH NATIVE MATERIAL AND COMPACT TO PROVIDE STABLE ANCHORAGE.
- IF A PREFABRICATED SILT FENCE IS NOT BEING USED, THE GEOTEXTILE MUST BE ATTACHED TO THE POSTS USING STAPLES, REINFORCING WIRE, OR OTHER ATTACHMENTS PROVIDED BY THE MANUFACTURER.
- WIRE SUPPORTS SHALL BE USED ON SILT FENCES EXCEEDING 24" IN HEIGHT.
- SILT FENCES SHALL BE USED PRIOR TO THE ESTABLISHMENT OF EROSION CONTROLS AND INSTALLED PRIOR TO THE CLEARING OF EXISTING VEGETATION.

B	SILT FENCE
C1	SCALE: NOT TO SCALE

A	SITE PLAN
C1	SCALE: 1" = 40'-0"

LEGEND

- AREA GRUBBED & CLEARED TO BE RESEEDING
- ▨ SILT FENCE
- EVERGREEN TREE (NEW)
- EXISTING VEGETATION
- PROPERTY CORNER ANGLE POINT, NOTHING FOUND
- FOUND PROPERTY CORNER AS NOTED
- FIRE HYDRANT
- WATER VALVE
- UTILITY POLE
- STORMDRAIN MANHOLE
- SEWER MANHOLE
- ELECTRIC BOX
- SIGNAGE
- BENCH MARK
- BOLLARD
- ELECTRIC LINE (OVERHEAD)
- X — FENCE (EXISTING)
- X — FENCE (FUTURE)



SPECIAL USE PERMIT APPLICATION
SOULE PROPERTY CLEAN UP
 NORTHWEST END OF WELCOME WAY
 APN: 049-165-06 & 049-165-07
 RENO, NEVADA 89511

REVISIONS

SHEET TITLE
 SITE PLAN

DRAWN: KN
 CHECKED: KN
 DATE: 7/9/18
 JOB NUMBER: JP #18094

C1